

AUTOMOTIVE TECHNICIAN TRAINING



1

TOM DENTON

LEVEL 1



Automotive Technician Training (ATT)

Copyright © ATT Training Ltd. - Tom Denton, BA, FIMI,
MIRTE, MSAE, Cert Ed

Online editions may also be available for this title.

Please visit www.atttraining.com for more information.

All rights reserved by the author. No part of this publication can be reproduced, stored in a retrieval system, or transmitted in any form or by any means, electronic, mechanical, photocopying, recording or otherwise, without the prior permission of the publishers and/or authors.

This publication does **not** form part of any photocopying licence agreement.

AUTOMOTIVE TECHNICIAN TRAINING



1

TOM DENTON

ACKNOWLEDGEMENTS

Over the years many people have helped in the production of my books. I am therefore very grateful to the following companies who provided information and/or permission to reproduce photographs and/or diagrams:

AA Photo Library	Mazda	Unipart Group
AC Delco	McLaren Electronic	Valeo
Alpine Audio Systems	Systems	Vauxhall
ATT Training (UK and USA)	Mercedes Cars UK	VDO Instruments
Autologic Data Systems	Mitsubishi Cars UK	Volvo Media
BMW UK	NGK Plugs	Volkswagen cars
Bosch Gmbh	Nissan Cars UK	Wikimedia
Bosch Media	Most Corporation	ZF Servomatic
C&K Components	Peugeot UK	
Citroën UK	Philips	
Clarion Car Audio	PicoTech	
Delphi Media	Pioneer Radio	
Eberspaecher	Porsche Cars UK	
Fluke Instruments UK	Robert Bosch GmbH.	
Ford Motor Company	Robert Bosch UK	
Ford Media	Rover Cars	
FreeScale Electronics	Saab Cars UK	
General Motors	Saab Media	
GenRad	Scandmec	
Hella UK	SMSC	
Honda Cars UK	Snap-on Tools	
Hyundai UK	Sofanou (France)	
Jaguar Cars	Sun Electric UK	
Kavlico	Tesla Motors	
Loctite	Thrust SSC Land	
	Speed Team	
	T&M Auto-Electrical	

Lucas UK
LucasVarity

Toyota Cars UK
Tracker UK

If I have used any information, or mentioned a company name that is not listed here, please accept my apologies and let me know so it can be rectified as soon as possible.

HOW TO USE THIS BOOK

Introduction This book is for use with the 'Automotive Technician Training' blended eLearning material. The text and images are the same on screen and in this book - most importantly, the **images on screen are much larger** and often animated.

Diagrams Most of the diagrams in this book have numbered (or similar) labels. Use the computer material to find out what the labels should say and then write them in to the book. In some cases there will be a blank space where the diagram from the screen should be drawn in.

Notes Use this book as a workbook, make notes, add bullet points, underline things, make sketches and highlight important points. This is your book, so use it in whatever way works for you!

Online In most cases you will probably access the computer based materials through a college or training centre. However, the learning screens, questions, worksheets, activities (and more!) are also available at: www.atttraining.com.

Structure The main part of this textbook is set out as four units (engines, chassis, electrical and transmission), which are then divided into chapters that cover major areas of the vehicle; brakes and steering for example. The structure of the computer based material may be in a slightly different order but it is easy to find what you need.

Worksheets Practical worksheets, for use under supervision in the workshop, are included in a separate book as a PDF or printing. These match all the tasks outlined in this book as well as covering more practical activities.

Symbols A number of symbols are used as a reminder that you should complete different tasks:

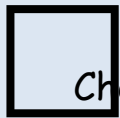

Check the computer for animations or videos (□)



Complete self-assessment questions



Draw a diagram in this space



Look back over the previous section and write out a list of the key bullet points



Worksheets to match the practical tasks in this textbook are in the support book

CONTENTS

<i>Acknowledgements</i>	2
<i>How to Use this Book</i>	4
<i>General Introduction</i>	18
Vehicle Layouts and Introduction	18
Health and Safety on Vehicles	35
Maintenance, Regulations and Information	49
Reasons for Maintenance and Inspections.....	49
Information Sources, Recording and Regulations.....	52
Workshop Bench Skills	54
Introduction	54
Fitting and Machining	54
Filing.....	56
Drilling.....	57
Cutting	58
Thread Cutting.....	60
Joining.....	63
Nuts And Bolts.....	65
Adhesives	68

Soldering	71
Brazing.....	72
Welding.....	72
Shrinking	75
Riveting.....	77
Gaskets	78
Sealants	80
Oil Seals	81
Valeting	84
Overview, equipment and safety	84
Exterior cleaning	89
Interior cleaning.....	100
The Motor Trade	103
Introduction	103
Types of MV companies.....	105
Company Structure	107
Role of a franchised dealer	108
Reception and booking systems	108
Parts department	110

Estimating Costs and Times	112
Job Cards and Systems.....	113
Invoicing.....	114
Computerised Workshop System	116
Warranties.....	124
Background Studies.....	126
Introduction	126
Science.....	131
Electricity	140
Materials	152
Mechanical Machines	155
Maths	159
Drawings.....	162
<i>Safety and General Units.....</i>	<i>167</i>
Contribute to Workplace Good Housekeeping.....	167
Legal Requirements	167
General Housekeeping.....	170
Equipment Maintenance.....	175
Ensure Your Own Actions Reduce Risks to Health and Safety.....	179

Introduction to Health and Safety	179
Health and Safety Regulations	182
Good Working Practices	187
Look after Yourself, Your Workshop and Your Workmates.	193
Maintain Positive Working Relationships	203
Working Relationships	203
Communication.....	206
<i>Engine Systems</i>	219
Engine Mechanical	219
Introduction and Operating Cycles.....	219
Engine Components	239
Engine Operating Details	243
Engine Terminology and Systems	269
Routine Maintenance	309
Engines - Customer Care	319
Engine Lubrication	321
Friction and Lubrication	321
Lubricating Oils.....	322
Engine Oil Specifications	324

Lubrication System Operation.....	328
Oil Pumps and Filtration.....	332
Routine Maintenance.....	342
Lubrication - Customer Care.....	348
Engine Cooling.....	350
Introduction.....	350
System Requirements.....	356
Components and Operation.....	358
Cooling & Heating.....	365
Antifreeze.....	368
Routine Maintenance.....	370
Air Supply, Exhaust and Emissions.....	377
Air Pollution from Motor Vehicles.....	377
Engine Combustion.....	381
Systems Development for Environmental Protection.....	384
Air-Supply System and Intake Air Temperature Control....	387
Exhaust Systems.....	395
Tools and Equipment.....	401
Routine Maintenance.....	404

Air and Exhaust - Customer Care	412
Ignition	416
Introduction	416
Components	420
Spark Plugs and Secondary Circuit	432
Electronics and System Operation	443
Dwell and Timing	451
Tools and Equipment	456
Routine Maintenance	460
Fuel Systems	472
Introduction	472
Carburetors (optional)	480
Electronic Fuel Injection Systems	500
Diesel Introduction.....	535
Tools and Equipment	555
Routine Maintenance.....	561
Fuel - Customer Care	569
<i>Electrical Systems</i>	571
Electrical and Electronic Principles	571

Electricity and the Atom	571
Basic Electric Circuits and Magnetism.....	576
Vehicle Electrical Components and Circuits	582
Tools and Equipment	597
Routine Maintenance	599
Electrical and Electronic - Customer Care.....	602
Engine Electrical	604
Introduction and Battery Construction.....	604
Battery Capacity and State of Charge	609
Battery Types and Charging.....	615
Checking Batteries	626
Battery Charging	634
Remove and Refit Batteries and Components.....	638
Servicing and Routine Repairs.....	644
Battery, Starting and Charging - Customer Care	648
Lighting and Indicators	650
Lighting Systems	650
Stoplights and Reverse Lights.....	656
Interior lighting.....	660

Tools and Equipment	664
Routine Maintenance.....	668
Lighting - Customer Care	672
Body Electrical and Electronic Systems.....	674
Washers, Wipers and Heated Screens.....	674
Horns, Obstacle Avoidance and Cruise Control.....	682
Mobile Multimedia	691
Tools and Equipment	699
Routine Maintenance.....	701
Body Electrical - Customer Care	705
Monitoring and Instrumentation	708
Sensors.....	708
Gauges.....	713
Tools and Equipment	720
Routine Maintenance.....	722
Instrumentation - Customer Care.....	726
Heating, Ventilation and Air Conditioning.....	728
Ventilation Systems	728
Vehicle Heating.....	730

Tools and Equipment	735
Routine Maintenance.....	739
Heating and AC - Customer Care.....	744
<i>Chassis Systems</i>	747
Suspension	747
Reasons for suspension.....	747
Springs.....	758
Dampers/Shock Absorbers	771
Tools and Equipment	779
Routine Maintenance.....	783
Suspension - Customer Care.....	788
Steering	790
Introduction to Steering.....	790
Steering Racks and Boxes	795
Introduction to Power Steering.....	808
Tools and Equipment	812
Routine Maintenance.....	817
Steering - Customer Care.....	820
Brakes	822

Introduction	822
Disc, Drum and Parking Brakes	830
Hydraulic Components	839
Tools and Equipment	846
Routine Maintenance	850
Brakes - Customer Care	855
Wheels and Tyres	857
Types of Wheel.....	857
Wheel rims and fixings.....	861
Tyres Introduction	867
Wheel Balancing.....	875
Tools and Equipment	879
Routine Maintenance.....	883
Wheels and Tyres - Customer Care.....	886
<i>Transmission Systems</i>	<i>888</i>
Manual Transmission Clutch	888
Transmission System Overview	888
Purpose of the Clutch Components	893
Clutch Operating Mechanisms.....	897

Tools and Equipment	901
Routine Maintenance.....	905
Clutch - Customer Care	908
Manual Transmission Gearbox	910
Gearbox Operation.....	910
Gear Change Mechanisms.....	914
Tools and Equipment	920
Routine Maintenance.....	924
Manual Gearbox - Customer Care.....	926
Transmission Driveline	929
Propshafts.....	929
Driveshafts.....	932
Rear Wheel Drive Bearings	936
Front Wheel Drive Bearings.....	941
Tools and Equipment	944
Routine Maintenance.....	947
Driveline - Customer Care.....	951
Final Drive and Differential	954
Final Drive.....	954

Differential Operation.....	961
Tools and Equipment	966
Routine Maintenance.....	971
Customer Care.....	974

GENERAL INTRODUCTION

VEHICLE LAYOUTS AND INTRODUCTION

(Remember to add notes and bullet points from each screen as you work through the material)

Introduction This section is a general introduction to the car as a whole. Over the years many unusual designs have been tried, some with more success than others. The most common is of course a rectangular vehicle with a wheel at each corner! To take this rather simple idea further, we can now put 'light vehicles' in one of five groups: ✎



Front engine driving the front wheels

Front engine driving the rear wheels

Front engine driving all four wheels

Rear engine driving the rear wheels

Mid-engine driving the rear wheels

The most common layout these days is the front engine, front wheel drive vehicle. This will be examined in more detail in a later.

Terminology Here are some useful words and abbreviations to learn:

FWD



RWD



AWD



4WD



Light vehicle



Light vehicle types

These can range from small two-seater sports cars to quite large people carriers or SUVs. Also included in the range are light commercial vehicles such as vans and pick-up trucks. Shown here are a number of

different types; saloon, estate, hatchback, coupe, convertible, van and a pick-up truck.

Vehicle systems This is a term used to describe a set of related components on the vehicle. For example all the components used to make the brakes work, are described simply as the 'braking system'.

A bit of history As you learn more about the fascinating world of the automobile, you will keep meeting 'new' technologies. I have included a list of events and dates for you to see that some new ideas are not as 'new' as you first thought! By the way you don't need to learn this bit, it is for interest only.

- 1769 Cugnot built a steam tractor in France.
- 1801 Trevithick built a steam coach.
- 1860 Lenoir built an internal-combustion gas engine.
- 1876 Otto improved the gas engine.
- 1885 Daimler developed a petrol engine and fitted it to a bicycle.
- 1885 Benz fitted his petrol engine to a three-wheeled carriage.
- 1906 Rolls-Royce introduced the Silver Ghost.
- 1908 Ford also used an assembly-line production to manufacture the Model T.
- 1911 Cadillac introduced the electric starter and dynamo lighting.

- 1938 Germany produced the Volkswagen Beetle.
- 1948 Jaguar launched the XK120 sports car and Michelin introduced a radial-ply tyre.
- 1955 Citroen introduced a car with hydro-pneumatic suspension.
- 1957 Wankel built his first rotary petrol engine.
- 1959 BMC (Rover Cars) introduced the Mini.
- 1966 California brought in legislation regarding air pollution by cars.
- 1991 European Parliament voted to adopt stringent control of car emissions.
- 2006 Satellite navigation systems are used on many vehicles
- 2007 Telematics becomes more important and more accurate satellite navigation is introduced
- 2008 Combined active and passive safety systems
- 2009 The story continues with you!

Front engine FWD

A design of vehicle with the engine at the front has a number of advantages.

- Protection in case of a front end collision
- Easier engine cooling because of the air flow
- Cornering can be better if the



weight is at the front

- Front wheel drive adds further advantages particularly if the engine is mounted sideways on (transversely).
- More room in the passenger compartment
- Power unit can be made as a complete unit
- Drive acts in the same direction that the steered wheels are pointing

Front engine RWD Rear wheel drive from a front engine was the method used for many years. Some manufacturers have continued its use, BMW for example. A long propeller shaft from the gearbox to the final drive, which is part of the rear axle, is the main feature. The propshaft has universal joints to allow for suspension movement. This layout has some advantages.

- Weight transfers to the rear driving wheels when accelerating.
- Complicated constant velocity



joints such as used by front wheel drive vehicles, are not needed.

Four wheel drive combines all the good points mentioned above but does make the vehicle more complicated and therefore expensive. The main difference with four wheel drive is that an extra gearbox known as a transfer box is needed to link the front and rear wheel drive.

Rear engine The rear engine design has not been very popular but it was used for the best-selling car of all time - the VW beetle. The advantages are that weight is placed on the rear wheels giving good grip and the power unit and drive can be all one assembly. One down side is that less room is available for luggage in the front. The biggest problem is that handling is affected because of less weight on the steered wheels. Flat type engines are the most common choice for this type of vehicle.



Mid-engine Fitting the engine in the mid position of a car has one major disadvantage; it takes up space inside the vehicle. This makes it impractical for most 'normal' vehicles. However, the distribution of weight is very good. This makes it the choice of high performance vehicle designers. A good example is the Ferrari Testarossa. Mid-engine is used to describe any vehicle where the engine is between the axles, even if it is not in the middle!



Chassis Vehicle chassis can be of two main types: separate or integrated. Separate chassis are usually used on heavier vehicles. The integrated type, often called monocoque, is used for almost all cars.

The two types are shown here.



Body Shown here is a car and a list of body panel names. Click the buttons in turn to reveal the panel or other body component. 🗑️

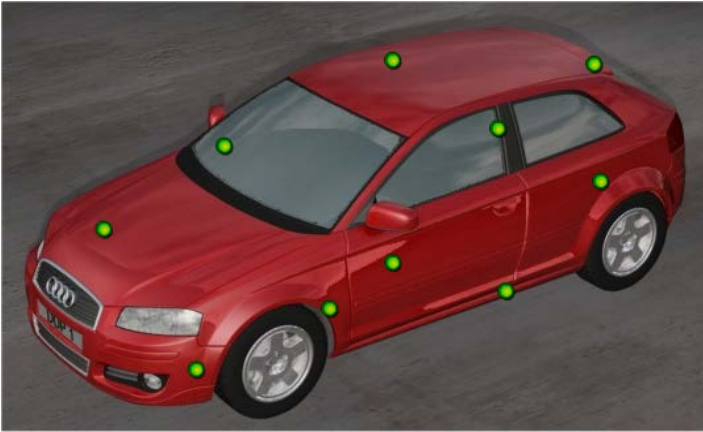

Front engine FWD detailed layout Front engine front wheel drive is now the most common layout, so this will be used for a more detailed explanation. All layout designs however, have similar major components and these operate in much the same way. The main systems of a front engine front wheel drive car are as follows:

- Power train, consisting of; Engine, clutch, gearbox, final drive and drive shafts (engine and transmission system combined).
- Braking system
- Steering system
- Suspension system
- Electrical system

Power train There are various groupings of engine, clutch, gearbox and final drive. One of the most common is shown here. The basic power flow, meaning the way in which energy is passed through the system, is as follows:

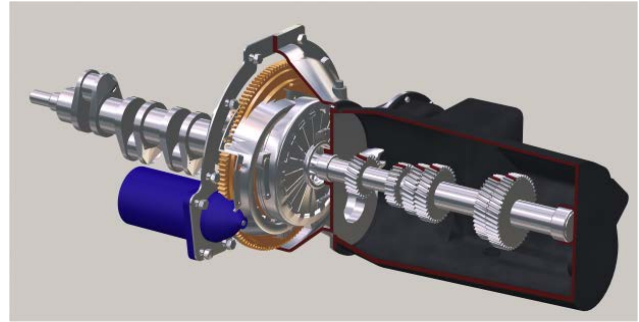

As fuel and air mixture is ignited above the pistons, they push on connecting rods which are on cranks, just like a cyclist's legs driving pedals. This makes the crankshaft rotate. Power is passed through the clutch and then through a gearbox. The output of the gearbox is linked to the final drive. This then applies the power to the front wheels through drive shafts. These shafts have joints so they can move with the steering and suspension.

Engine A fuel air mixture enters through an inlet manifold and is fired in each cylinder in turn. This expands and pushes down on the piston. The spent gases leave via the exhaust system. The power is applied to the crankshaft. The pulses of power from each piston are smoothed out by a heavy flywheel. Power leaves the engine through the flywheel which is fitted on the rear of the rotating crankshaft and passes to the clutch.

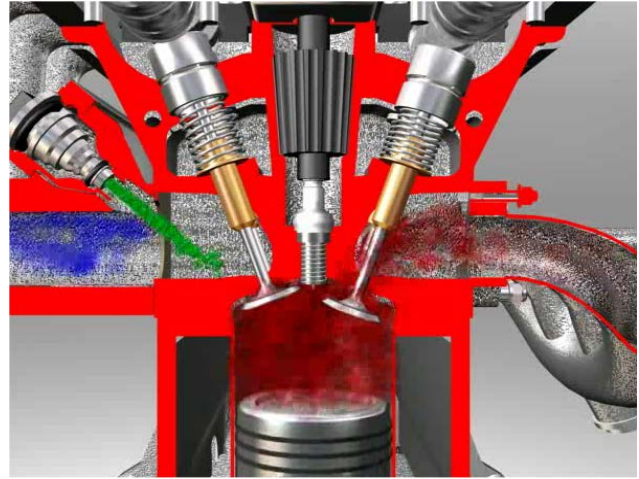

Clutch The clutch is to allow the driver to disconnect drive from the engine and move the vehicle off from rest. The engine flywheel and clutch cover are bolted together so the cover always rotates with the engine. A pressure plate and clutch springs are mounted on the cover. A gearbox shaft

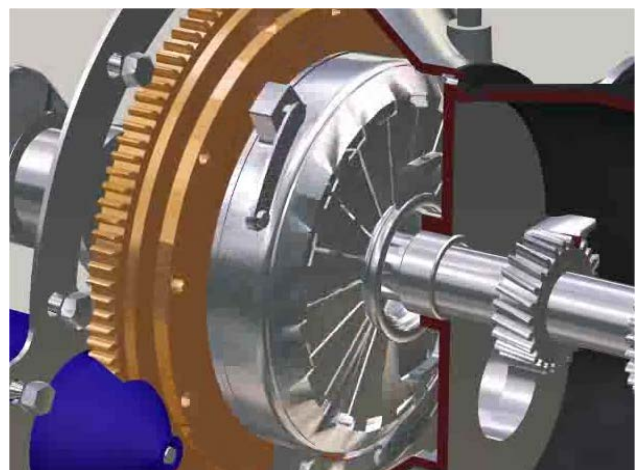

is fixed so that it rotates with the clutch driven plate but it can slide slightly. The clutch, or driven plate has friction linings. The clutch is engaged when the pedal is up because the clutch springs and pressure plate hold the driven plate against the flywheel. This makes the drive pass to the gearbox. To disengage the clutch the pedal is pressed down. A release bearing makes the pressure plate move back away from the flywheel, and frees the driven plate from the flywheel. No drive is now passed to the gearbox.

Gearbox A gearbox is needed because an engine produces power only when turning quite fast. The gearbox allows the driver to keep the engine at its best speed. When the gearbox is in neutral, power does not leave it. When the gearbox is

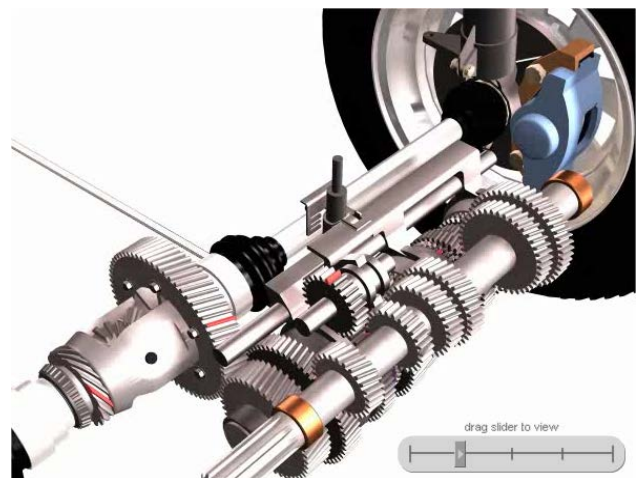

in first gear, power is transferred from a small to a larger gear, and then out to the final drive. Different stages of speed reduction (second and third gear) are created using different sizes of gear. Less speed out of the gearbox has a higher turning force (torque) because the engine is running faster. Fourth gear normally makes the output shaft turn at the same speed as the engine. Fifth gear makes the output shaft run faster than the engine for economical higher speed driving.

Final drive The final drive assembly of a front wheel drive vehicle has two main tasks:

- Further speed reduction of about 3:1. This is output gear to pinion ratio which will vary with

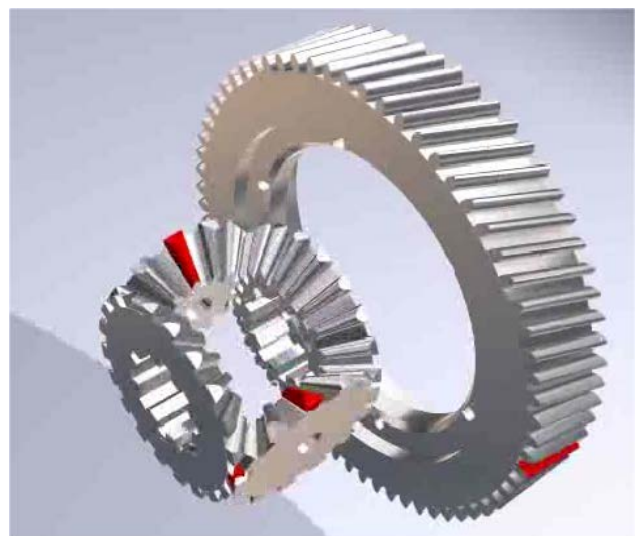

different types of vehicles and engines.

- Different speeds to the drive shafts must be possible by a unit called the differential. This is needed because when the vehicle is cornering the road wheels turn at different speeds.

Drive shafts The two drive shafts each have two constant velocity (CV) joints. They are heavy duty steel shafts and simply pass the drive to the wheels. The joints are needed because the movement of the steering and suspension changes the position of the wheels.



Braking system Hydraulic brakes are used to slow down or stop the vehicle. The hand brake uses a mechanical linkage to operate parking brakes. The main brakes work on all four wheels and the hand brake usually just on the rear. The hydraulic principle is that foot pressure on the brake pedal pushes fluid under pressure to all four wheels. Braking materials (friction linings) are pressed against rotating surfaces, slowing them down thereby slowing down the vehicle. Discs, normally on the front, are gripped between pads of friction lining. Drums, normally on the rear, are gripped on their inside surfaces by shoes covered with friction lining. This is the most common arrangement but some vehicles have all drums or all discs.

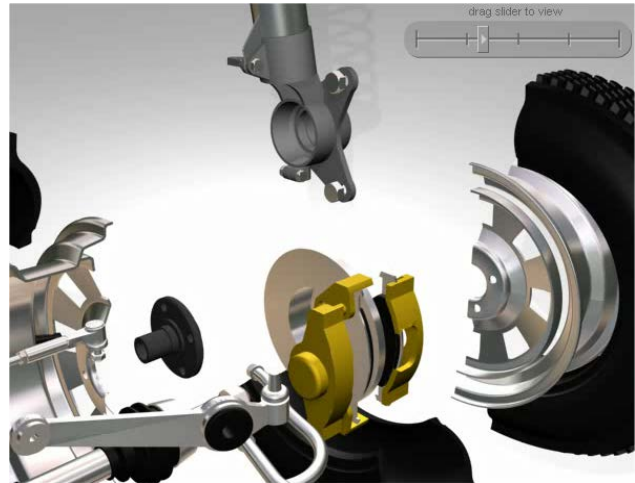

Steering system Both front wheels are linked mechanically and must turn together to provide steering control. The image here shows a rack and pinion. The steering wheel is linked to the pinion and as this is turned it moves the rack to and fro. This moves both the wheels. Many vehicles have power assisted steering which uses a pump driven by the engine to make turning the steering wheel easier. Some very modern systems use small electric motors for this task.



Suspension system The main reasons for the suspension system are as follows:

- Absorb road surface faults (shocks) to give a comfortable ride
- Keep the tyres in contact with the road surface
- Resist braking and

steering forces

- Allow for different loads of passengers and luggage

A single trailing arm with coil springs and damper on the rear and strut with a coil spring and built in damper on the front are shown here. Many variations of design are used but the principle is the same.

 Draw the suspension spring before and after the wheel hits a bump...

Tyres also absorb road shock and play a very important part in road holding. Most of the remaining shocks and vibrations are absorbed by springs in the drivers and passengers seats.

Electrical system The electrical system covers many aspects such as lighting, wipers and instrumentation. A key aspect is the production of a spark to ignite the fuel (unless the engine is diesel of course). An alternator, driven by the engine, produces electricity to run the electrical systems and charge the battery.



Summary Layouts of a vehicle vary as do body styles and shapes. However, the main systems of a light vehicle are very similar. These are the:

- Power train
- Braking system
- Steering system
- Suspension system
- Electrical system

These systems are covered in more detail in other sections of 'Automotive Technician Training'



Look back over the previous section and write out a list of the key bullet points here:

HEALTH AND SAFETY ON VEHICLES

This section is an overview of some key aspects relating to safe working practices. Every subject or topic of the multimedia material has some further guidance that you should also work through as you study each area.

Lifting and Supporting the Vehicle Lifting and supporting the vehicle should follow standard safe working practices particularly when under vehicle inspection and repair work is required. The vehicle should be lifted on the manufacturer's specified lifting and supporting points. When using a vehicle lift do not exceed the safe weight limit (SWL) and be careful to distribute the weight so that the vehicle does not over balance when the weight of the engine is transferred to the engine crane or taken by a trolley.

Mechanical Lifting Whenever lifting an engine inspect the crane, and chains, slings or ropes before use. Always keep sling legs as long as possible in order to reduce the strain in each leg. Exceeding an angle of 90° should be avoided. The stress in the pair of legs is approximately one and a half times the weight of the engine at a 90° angle. Carefully select the lifting eye positions to ensure that they will not bend or shear. Keep fingers and hands clear of the sling as the weight is taken up, as this is the most likely time to get caught. During the lifting operation when the engine is being guided within the engine compartment, keep hands clear so that they are not trapped or

squashed. Take care to avoid damage to other components of the vehicle.

Sharp Objects Engine components are made from hard materials by various manufacturing methods that can produce very sharp corners. Minor cuts are common but more serious cuts can occur. Always treat cuts and grazes immediately. Avoid close work by selecting tools that bring hands away from sharp points. Socket extensions are suitable for this.

Protective Clothing During cleaning operations, chemicals or hot water or steam are used and personal protective clothing and procedures that are described in the manufacturer's manuals or data sheets must be followed.

Engine Oils Particular points to be aware of, and to take care with, are hot oil, the health hazards of engine oils, and proper disposal to avoid environmental contamination.



Oil drainer in use

Skin Contact with Engine Oils Avoid skin contact with new and used engine oils. Use a barrier cream or non-porous gloves. Be careful with hot oil, particularly when carrying out oil-draining operations.

Oily Rags and Contaminated Clothing Never keep oily rags in overall, or other pockets, and change out of oil-contaminated clothing as soon as reasonably possible.

Disposing of Used Engine Oils Dispose of used engine oil to a licensed waste-disposal company, or to an approved collection point. Never pour any oils into a drain or onto the ground. Oils are often carcinogenic and can cause cancers.

Grade and Type of Oil In consideration of the 'duty of care' to other people's property, always be careful to use the correct grade and type of oil for oil changes.

Pressure-Relief Valves Pressure-relief valves are controlled by spring tension. Always wear safety goggles when removing and replacing these because they can, in some circumstances, fly out with their own spring force.

Oxyacetylene When removing parts of the exhaust system, it may be necessary to use an oxyacetylene flame to heat up pipes. This is to free them so they can be separated. Always follow standard safety precautions for the use of the equipment. Be very careful that the flame is directed ONLY onto the exhaust-pipe joint, and always pointing away from fuel pipes and the vehicle floor. Use protective screens where flammable substances are in the area of the flame, or consider another method if the fire risk is too high.

Avoid Fires The main safety precautions to avoid fires where fuel or vapour is likely to be around, is to disconnect the vehicle

battery whenever it is not required for the current task. Mark off with warning signs a 'no naked flames' work area. Obtain, and keep close by, a suitable fire extinguisher such as CO₂. When checking cylinder compressions or any similar task disable the ignition system.



Check which extinguishers are safe to use on fuel fires

Draining Fuel Never drain fuel into an open container such as a bowl, oil drain tray or cans where there is a risk of spillage from overflowing. Always use a pumped, sealed and earthed or grounded tank that is specially constructed for the job.



Fuel drainer

Skin Care All fuels and oils are harmful to skin and internal organs. The range of hazards is from drying out of the skin to dermatitis and cancers. Avoid prolonged or frequent contact with fuels and oils. Use a barrier cream or suitable gloves and wash after any skin contact as soon as reasonably possible. Replace skin oils with a lanolin cream. Never keep contaminated cloths in pockets.

Pressurised Systems Many fuel systems are pressurised. The hazard from pressurised fuel occurs when the pressure is released. In the case of petrol, the risk is from a spray when a pipe or hose is loosened or punctured. The petrol spray could cause a fire if ignited and a personal injury if sprayed into the eyes. Involuntary movement into a rotating component is also possible. Always wear safety goggles when working with pressurised fuel lines.



Fuel is under pressure

Releasing Fuel Pressure Most petrol fuel injection systems have a method for releasing the fuel pressure. In some cases, a pressure release valve is fitted to the fuel rail. In others, it may be necessary to disable the fuel pump by removing a fuse or relay and running the engine until it stalls. Some systems may need a pipe union or joint to be gently eased to release the pressure. In all cases, follow the manufacturer's instructions.



Fuel pressure valve

Compressed Air It is sometimes required to use an air line to clean components or fuel pipelines. Take care with compressed air. It must not be directed towards the skin. Always wear safety goggles when using an air line.

Diesel Injection Systems Diesel injection systems work at very high pressures. Particular care must be exercised to ensure that diesel fuel is not injected through the skin and into the body. This risk is greatest when carrying out tests on injectors. Always follow correct safety and operational procedures for these tests. Wear a full-face visor when working with high-pressure test equipment.

Arc Welding Electronic modules should be removed from the vehicle whenever any electrical arc welding is being carried out on the vehicle.



Remove ECU before welding

Automatic Transmission For vehicles with automatic transmission, ensure that 'park' is selected and kept in place during all engine running tests except when a gear selection is required for a specific test. Work to the side of the vehicle whenever possible as an additional safety precaution.

Test Instruments Observe all standard procedures for the use of electrical instruments. Always observe the correct polarity, range, and connections.

High Voltages Ignition circuits use pulses of electrical energy in excess of 10,000 volts. These are created in the ignition coil, and conducted through the coil and spark-plug wires. Although shocks from ignition systems are rarely fatal, the reaction to the shock may cause serious injury, such as the involuntary movement of hands and arms, or whole body movements, into hazardous areas like running engines.

Running Engines Whenever carrying out tests on running engines, an awareness of rotating components must be maintained. This is particularly important when using a stroboscopic-timing light because it can give the impression that the engine is stationary. Exhaust extraction should always be used.

Cooling Fans Keep fingers clear of electrically operated cooling fans because they are likely to start without warning during running-engine tests.

Short Circuits As with all electrical work, there is a risk from short circuits to ground causing fires and very hot strands of wire. Follow standard procedures with the removal and reconnection of the battery earth lead whenever working on electrical components. This is advisable for all tasks, except when the battery has to be connected for the work to be

carried out. Note that it may be necessary to use a 'keeper' to keep memory circuits alive if the battery is disconnected.

Working Below Vehicles There are a number of hazards to avoid when working below vehicles. One is the risk of hitting your head, which can obviously cause injury. Another risk is the possibility of getting rust and dirt in the eyes. Avoid these problems by wearing a bump cap and goggles, whenever working below vehicles. The vehicle must always be supported safely before working underneath or alongside it.



Car on a ramp

Overheated Coils Contact-breaker ignition coils can become very hot if the ignition is left on without the engine running. However, most electronic systems require the engine to be started to trigger the switching of the primary circuit. These systems will not overheat.



DIS coil

Arcing and Sparking! For all electronic-ignition systems, avoid causing arcing when disconnecting terminals. This is achieved by disconnecting the battery earth lead, or at least turning off the

ignition. Do not allow high-voltage secondary-circuit sparks of more than 5 to 6mm to occur during test procedures. This can cause damage to electronic components. It is recommended that electronic modules be removed if arc welding is required on the vehicle.

Battery Polarity When fitting and connecting a battery it is important to observe the correct polarity. This is necessary to reduce the risk of damage to the electrical and electronic systems on the vehicle. A memory saver device may be needed for some vehicles. Check with the vehicle manufacturer's data before disconnecting the battery.



Battery polarity



Memory saver

Battery Connection When connecting and disconnecting the battery leads ensure that all electrical systems are switched off. This will reduce the risk of arcing, which can cause damage to electronic components.

Earth Lead Off First! Always disconnect the earth or ground lead **first**; when reconnecting, connect it **last** and touch the lead to the battery terminal and look for arcing. Arcing occurs when a circuit or a short circuit is made.

Lifting Batteries Be careful when lifting batteries that they are not tipped to the point where the acid escapes. When using

lifting equipment of the cross grip type, take care that the battery case is not fractured.

Battery Acid Mixing battery acid is not now a common task. However, if acid is to be mixed, all safety rules must be followed. This operation should only be carried out in a place specially prepared and designated for the purpose. Safety-wear includes a PVC apron and gloves, and a chemicals-rated face visor. One rule above all others must be remembered, and that is that acid is added to the distilled water. Water added to acid will boil on contact causing an explosive reaction.

Lifting Heavy Objects Batteries should be treated as heavy objects when being lifted. Add to this that there are special conditions attached because of the acid content. It is, therefore, important to plan the lift procedure beforehand and to have the correct equipment available if required. Many modern vehicle batteries that are more than 20 kg (40 lbs.) in weight, are fitted with lifting ropes and handles. Check that these are in good condition before lifting.

Flammable Gas The gas that is given off from a battery during charging is a mixture of hydrogen and oxygen. This is a highly flammable and potentially explosive mixture that can be ignited with a spark or other hot or burning object.

Battery Charging Always charge batteries in a well-ventilated area, switch off the battery charger, and leave for about 5 minutes before disconnecting the battery leads. This will avoid a

high concentration of gas, and the risk of a spark, being brought together near the battery. Always ensure that the battery charging area is a no smoking area and that notices are posted to ensure that this rule is observed.

Disposal of Batteries The disposal of batteries and battery acid is subject to local environmental regulations. If procedures are not in place in your workshop, seek advice from your local environmental agency. Never dispose of batteries with normal waste. Many areas have a collection site for hazardous materials and batteries can normally be taken to those sites.



Battery disposal in accordance with local environmental regulations

Skin Contact When servicing vehicle systems avoid skin contact with new and used engine oils. Use barrier cream or non-porous gloves. Be careful with hot oil, particularly when carrying out oil draining operations. Never keep oily rags in overall or other pockets and change out of oil contaminated clothing as soon as reasonably possible.

Exhaust Emissions When running an engine, it is important to prevent the build-up of exhaust gas in the workshop. Use extraction equipment or provide good ventilation.

Protective Clothing Overalls should ideally be worn at all times. This protects your clothes as well as your skin. Gloves, goggles, breathing masks, hats and strong footwear may also be necessary. Refer to local regulations for any special requirements.

Skin Contact When servicing vehicle systems avoid skin contact with new and used engine oils. Use barrier cream or non-porous gloves. Be careful with hot oil, particularly when carrying out oil draining operations. Never keep oily rags in overall or other pockets and change out of oil contaminated clothing as soon as reasonably possible.



Wear gloves or use barrier cream

Caution/Attention/Achtung! All types of fuel and particularly the vapours are highly flammable. They can be ignited from a number of sources. Any naked flame, a short circuit, a cigarette or under the right conditions a hot object, will start a fire.

Original Equipment In consideration of other people's property, always be careful to use approved parts. Original equipment manufacturers' (OEM) parts may be required to meet safety regulations.

Rotating Driveline Components The Ferrari shown here was under test on a rolling road. It was being driven at well in

excess of 100 mph! Note how important it is to ensure all driveline components are in good order.

Transmission Wind Up On four-wheel drive vehicles, it is possible for the transmission to 'wind up' when the front and rear axles are locked together. This is because the two axles may run at slightly different speeds. When on rough ground it is not a problem because the bouncing and movement allows the tyres to slip. On hard surfaces however, a twist or 'wind up' of the components such as driveshafts occurs. When the vehicle is jacked up, the transmission can unwind suddenly causing serious injury. This does not occur on a vehicle with an unlocked centre differential or a viscous drive.

Springs Under Compression When coil springs are removed from a suspension strut, they should be held using a special tool. If the fixings are removed without compressing the spring, it may release considerable energy and cause damage or personal injury.

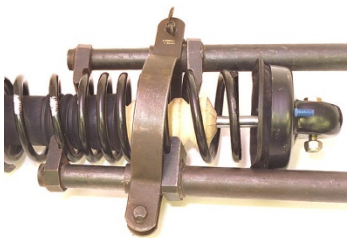

Coil spring in a compression tool

Refrigerant Refrigerant used in air conditioning systems are dangerous. If it comes in to contact with the skin, it produces severe frostbite. Wear protective goggles and gloves at all

times. Use gloves designed for the purpose; leather or fabric gloves are NOT suitable. If refrigerant is exposed to naked flames or hot surfaces, it produces toxic gases. Always ensure adequate ventilation when working on air conditioning systems.



Air conditioning unit and equipment

Pressurised Cooling Systems If work has to be carried out on the vehicle heater or the cooling system, there is a risk of scalding. The coolant is run at a pressure higher than atmospheric. If the cap is removed when hot, the coolant can boil instantly ejecting boiling water and steam.



Look back over the previous section and write out a list of the key bullet points here:

MAINTENANCE, REGULATIONS AND INFORMATION

REASONS FOR MAINTENANCE AND INSPECTIONS

Vehicle Protection Clearly, it is important to keep a customer's vehicle in a clean condition. To do this there are a number of methods as outlined here:

- Seat covers to keep the seats clean
- Floor mats to protect the carpets from dirt
- Steering wheel covers to keep greasy hand prints off the wheel
- Wing covers to keep the paintwork clean and to prevent damage.

Maintenance The purpose of routine maintenance is simple; it is to keep the vehicle in a good working order and in a safe condition.

Manufacturers specify intervals and set tasks that should be carried out at these times. It is usually a condition of the warranty that a vehicle should be serviced according to the manufacturers' needs.

Inspections The main purpose of regular inspection is to check for the following:

- Malfunction of systems and components
- Damage and corrosion to structural and support regions
- Leaks
- Water ingress
- Component and system wear and security

Inspections are usually:

- Aural - listening for problems
- Visual - looking for problems
- Functional assessment - checking that things work!

Types of Inspection The main types of inspection you may have to carry out are:

- Pre-work
- Post-work
- Pre-delivery inspection (PDI)
- Used vehicle inspection
- Special inspection (maybe after an accident for example)

A pre-work inspection is used to find out what work needs to be carried out on a vehicle. Post-work inspections are done to make sure the repairs have been carried out correctly and then no other faults have been introduced.

A PDI is carried out on all new vehicles to check certain safety items and to, for example, remove any transport packaging such as suspension locks or similar. A used vehicle inspection is done to determine the safety and saleability of a vehicle as

well as checking that everything works. After gaining experience you may be asked to carry out an inspection of a vehicle after an accident to check the brakes condition for example.

In all cases, a recommended checklist should be used and careful records of your findings should be kept.

Timescales Working to timescales, or reporting to a supervisor that timescales cannot be met, is essential for two reasons.

Firstly, when a customer books a car in for work to be done they expect it to be ready at the agreed time. Clearly if this time can't be met the customer needs to be informed.

Secondly, in order to make the running of a workshop efficient and profitable, a technician will have jobs allocated that will take a certain amount of time to complete. If for any reason the allotted time can't be met then action will need to be taken by the workshop manager or supervisor.

Summary There are more details on the maintenance and inspection requirements in the main subject area sections. As a summary, remember the following:

- Maintenance and inspections should be carried out at the times and in the way specified by the manufacturers
- Vehicle protection kits should always be used
- Keep to set timescales or, if this is not possible, inform your supervisor.

INFORMATION SOURCES, RECORDING AND REGULATIONS

Information Sources The main sources of information are:

- technical manuals
- technical bulletins
- servicing schedules
- job card instructions
- inspection records
- check lists

Documentation and Records It is essential that proper documentation is used and that records are kept of the work carried out. For example:

- job cards
- stores and material records
- manufacturers' warranty systems

These are needed to ensure the customer's bill is accurate and also so that information is kept on file in case future work is required or warranty claims are made.

Recording Results of Diagnostic Tests Results of diagnostic tests will be recorded in a number of different ways. The actual method will depend on what test equipment was used. Some equipment will produce a printout for example. However, results of all other tests should be recorded on the job card. In some cases this may be done electronically but the principle is the same. Remember to make sure that the records are clear and easy to understand.

Regulations The three main regulations that cover the repair and service of motor vehicles are as follows:

- Road Traffic Act - this covers things like road signage and insurance requirements. It also covers issues relating to vehicle safety. For example, if a car suspension was modified it may become unsafe and not conform to the law.
- VOSA regulations - the main one of these being the annual MOT test requirements. VOSA stands for: Vehicle and Operator Services Agency
- Highway code - which all drivers must follow and forms part of the driving test.

Summary To be able to carry out your work correctly and to the required standard it is important to use up to date and relevant information. Keep proper records of work done and parts used. This is to both keep customers informed and so the invoice can be prepared correctly. Further, it is important to protect yourself in the event of a claim being made against you or your company.



Look back over the previous section and write out a list of the key bullet points here:

WORKSHOP BENCH SKILLS

INTRODUCTION

As well as the obvious skills such as knowledge of the systems and the ability to use normal hand tools for vehicle repairs, bench fitting and in some cases machining skills are also essential.

This usually involves metal cutting operations but it can involve other materials such as wood and plastics. In this sense the work cutting is a very general term and can refer to:

- Sawing
- Drilling
- Filing
- Tapping
- Machining

These aspects will be examined in a little more detail in the following sections.

FITTING AND MACHINING

Fitting and machining skills may be needed to complete a particular job. In the context of an automotive engineer, we often use the term 'fitting' as a general description of hand skills usually used on a work bench or similar, to construct an item that cannot be easily purchased; a support bracket for a modified exhaust or a spacer plate to allow the connection of an accessory of some type such as additional lights.



Repairs using lathe (Source: Wikimedia)

Machinists usually work to very small tolerances, ± 0.1 mm for example and deal with all aspects of shaping and cutting. The operations most often carried out by machinists are milling, drilling, turning, and grinding. To carry out fitting or machining operations you should be familiar with:

- Measuring tools such as a micrometer
- Hand tools as found in a standard tool kit
- Machine tools such as a bench drill
- Work holders for example a vice
- Tool holders such as the chuck of a drill
- Cutting tools like saws and files



Tool kit



Bench Drill

FILING

Filing is the process of removing material when manufacturing something; it is used mostly for finishing operations. Filing can be used on a wide range of materials as a finishing process. Emery paper may be considered as a filing tool.



Hand filing (Source: South Thames College)

Files have forward-facing cutting teeth that cut best when pushed over the workpiece. A process known as draw filing involves turning the file sideways and pushing or pulling it across the work. This catches the teeth of the file sideways and results in a very fine shaving action.

Key Fact

Files have forward-facing

cutting teeth that cut best when pushed over the workpiece

Files come in a wide variety of sizes, shapes, cuts, and tooth configurations. The most common cross-sections of a file are: flat, round, half-round, triangular and square. The cut of the file refers to how fine its teeth are. They are described, from roughest to smoothest, as: rough, middle, bastard, second cut, smooth, and dead smooth. The picture shows three common file cuts. Most files have teeth on all faces, but some flat files have teeth only on one face or edge, so that the file can work against another edge without causing damage.

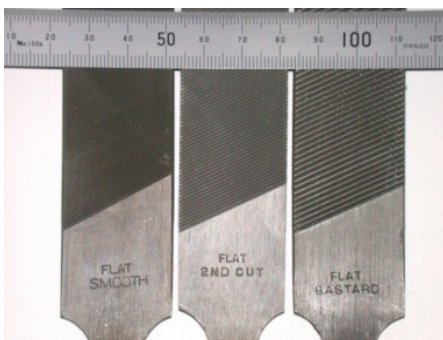

Three common types of file (Source: Glenn McKechnie, Wikipedia)

DRILLING

Drilling is a cutting process that uses a drill bit to cut or enlarge a hole in a solid material. The drill bit cuts by applying pressure and rotation to the workpiece, which forms chips at the cutting edge (see figure 1-80). The flutes remove these chips.

In use, drill bits have a tendency to 'walk' if not held very steadily. This can be minimized by keeping the drill perpendicular to the work surface. This walking or slipping across the surface can be prevented by making a centring mark before drilling. This is most often done by centre punching. If a large hole is needed, then centre drilling with a smaller bit may be necessary.



Make sure the safe guard is in place before drilling

Drill bits used for metalworking will also work in wood. However, they tend to chip or break the wood particularly at the exit of the hole. Some materials like plastics have a tendency to heat up enough during the drilling process. This heat can make the material expand resulting in a hole that is smaller than the drill bit used.

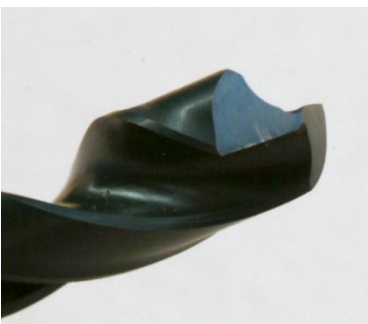

Cutting edges and flutes of a drill bit

CUTTING

A hacksaw is a fine-tooth saw with a blade under tension in a frame. Hand-held hacksaws consist of a metal arch with a handle, usually a pistol grip, with pins for attaching a narrow disposable blade. A screw or other mechanism is used to put the blade under tension. The blade can be mounted with the teeth facing toward or away from the handle, resulting in cutting action on either the push or pull stroke. The push stroke is most common.

Blades are available in standardized lengths, usually 10 or 12 inches (15 or 30 cm) for a standard hacksaw. Junior hacksaws are usually half this size. Powered hacksaws may use large blades in a range of sizes.



Junior hacksaw (Source: Evan-Amos, Wikipedia)

The pitch of the teeth can vary from eighteen to thirty-two teeth per inch (TPI) for a hand hacksaw blade. The blade chosen is based on the thickness of the material being cut, with a minimum of three teeth in the material. As hacksaw teeth are so small, they are set in a wave so that the resulting cut is wider than the blade to prevent jamming. Hacksaw blades are often brittle so care needs to be taken to prevent fracture.



Sawing machine (Source: Wikimedia)

THREAD CUTTING

Taps and dies are cutting tools used to create screw threads. A tap is used to cut the female part of the mating pair (e.g., a nut) and a die is used to cut the male portion (e.g., a screw). Cutting threads using a tap is called tapping and using a die is called threading. Both tools can also be used to clean a thread in a process known as chasing. The use of a suitable lubricant is recommended for most threading operations.



Figure 0-1 Die stock



Die



taps



Figure 0-2 Tap Wrench

A tap cuts a thread on the inside surface of a hole, creating a female surface which functions like a nut. The three taps in picture show the three basic types:

- The bottoming tap has a continuous cutting edge with almost no taper, which allows it to cut threads to the bottom of a blind hole.
- The intermediate tap, second tap, or plug tap has tapered cutting edges, which assist in aligning and starting it into an untapped hole.
- The taper tap is similar to a plug tap but has a longer taper, which results in a more gradual cutting action.

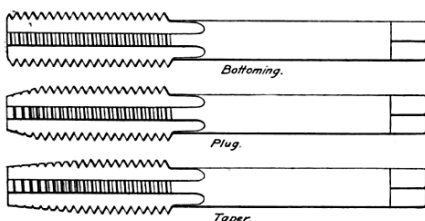

Taper, plug and bottoming taps (Source: Glenn McKechnie, Wikipedia)

The process of tapping begins with drilling and slightly countersinking a hole. The diameter of the hole is determined by using a drill and tap size chart.

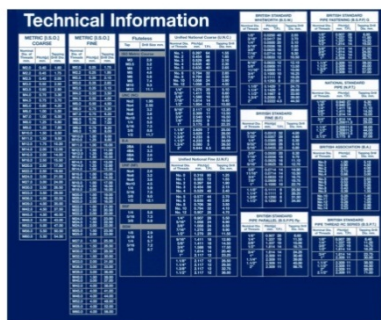
A technical information chart with a dark blue background and white text. It contains multiple columns of data, including tables for tap specifications, drill specifications, and other technical details. The text is small and dense, typical of a reference chart.

Tap drill size chart

A 'T' shaped handle is used to rotate the tap. This is often turned in steps of one turn clockwise and about a quarter turn back. This helps to break off the chips, which avoids jamming. With hard materials, it is common to start with a taper tap, because the shallower cut reduces the amount of torque required to make the threads. If threads are to be cut to the bottom of a blind hole, the taper tap is followed by an intermediate (plug) tap and a bottoming tap.



Dies (Source: Glenn McKechnie, Wikipedia)

The die cuts a thread on a cylindrical rod, which creates a male threaded piece that functions like a bolt. The rod is usually just less than the required diameter of the thread and is machined with a taper. This allows the die to start cutting the rod gently, before it cuts enough thread to pull itself along. Adjusting screws on some types of die allow them to be closed or opened slightly to allow small variations in size. Split dies can be adjusted by screws in the die holder. The action used to cut the thread is similar to that used when tapping.

Die nuts have no split for resizing and are made from a hexagonal bar so that a wrench or spanner can be used to turn them. Die nuts are used to clean up existing threads and should not be used to cut new threads.



Cylindrical rods

JOINING

It is very important for the correct methods of joining to be used in the construction and repair of a modern motor vehicle. Joining can cover many aspects ranging from simple nuts and bolts, to very modern and sophisticated adhesives.

The choice of a joining method for a repair will depend on the original method used as well as consideration of the cost and

strength required. Table 1-26 lists some typical joining methods which include the use of gaskets in some cases. An example of the use and useful notes are also given in the table.

Joining methods

Joining method	Example use	Notes
Pins, dowels and keys	Clutch pressure plate to the flywheel	Used for strength and alignment in conjunction with nuts or bolts in most cases.
Riveting	Some brake shoe linings	This involves metal pegs which are deformed to make the joint. The picture shows some pop rivets which are a popular repair component
Compression fitting	Wheel bearings	Often also called an interference fit. The part to be fitted is slightly too large or small as appropriate and therefore pressure has to be used to make the part fit.
Shrinking	Flywheel ring gear	The ring gear is heated to make it expand and then fitted in position. As it cools it contracts and holds firmly in place.
Adhesives	Body panels and sound deadening	Adhesive or glue is now very popular as it is often cheap, quick, easy and waterproof. Also when two items are bonded together the whole structure becomes stronger.
Nuts, screws, washers and bolts	Just about everything!	Metric sizes are now most common but many other sizes and thread patterns are available. This is a very convenient and strong fixing method. The image shows how varied the different types are

Welding	Exhaust pipes and boxes	There are several methods of welding. Oxy-Acetylene and MIG being the most common. The principle is simple in that the parts to be joined are melted so they mix together and then set in position.
Brazing	Some body panels	Brazing involves using high temperatures to melt brass which forms the join between two metal components.
Soldering	Electrical connections	Solder is made from lead and tin. It is melted with an electric iron to make it flow into the joint.
Clips, clamps and ties!	Hoses cables etc.	Hose clips for example, are designed to secure a hose to say the radiator and prevent it leaking.



A selection of joining or fastening components

Methods of joining are described as permanent or non-permanent. The best example of the first of permanent joining is any form of welding. An example of the second would be nuts and bolts. In simple terms then, the permanent methods would mean some damage would occur if the joint had to be undone.

NUTS AND BOLTS

The nut and bolt is by far the most common method of joining two components together. This picture shows some common nuts and bolts. The head of the bolt is usually a hexagon, but an Allen socket or a Torx® drive or a number of other designs are used. Smaller bolts can have a screwdriver type head such as a slot, cross, Philips, Pozidrive or some other design.



Nuts and bolts

The material used to make a nut or bolt depends on the application. For example, sump bolts will be basic mild steel whereas long through bolts on some engines, are made from sophisticated high tensile steel so that they will stretch. The size of the nut and bolt will of course depend on the size of components to be secured. Thread sizes used to be a problem, but fortunately now most nuts and bolts are metric. The picture shows a metric thread profile.

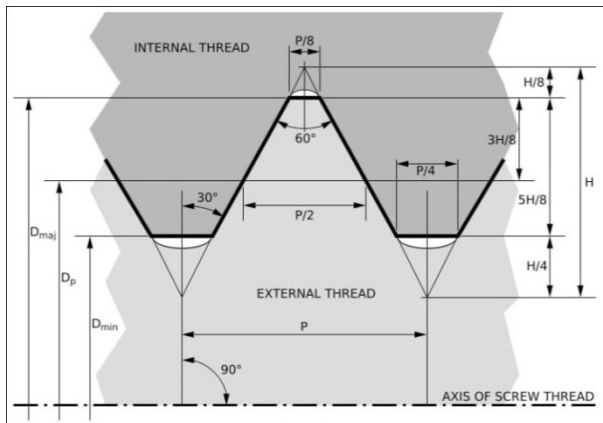

ISO Metric thread profile (the M10 in the given example refers to D_{max} and the 1.5 refers to P)

Metric nuts and bolts are described as in the following example:

M10 x 1.5

The M is metric, the 10 is the bolt diameter and the 1.5 is the pitch of the thread.



A bolt

When joining with nuts and bolts it is common to find flat washers and in many cases some type of locking device. Metric threads are quite good at locking in position as they are, but for safety, extra devices are often used. Vibration is the main cause of bolts coming loose, as well as them not being tightened to the correct torque in the first place of course. The picture

below shows a selection of locking devices including a Nyloc (nylon lock.)



Nyloc Nut

Another common method of securing threads is to use a locking compound such as 'Loctite'. This is in effect an adhesive which sticks the threads together. When the correct compound is applied with care, it is a very secure way of preventing important components from working loose (figure 1-90).



Loctite® Threadlocker (Source: © 2010 Henkel AG & Co. KGaA, Düsseldorf. All rights reserved)

ADHESIVES

A very wide range of adhesives is used in today's automotive industry. The number of applications is increasing daily and tending to replace older methods such as welding. There are too many types of adhesives to cover here but most of the basic

requirements are the same. It is very important to note however, that manufacturer's instructions must always be followed. This is because of the following:

- Many adhesives give off toxic fumes and must be used with care
- Most types are highly flammable
- Adhesives are often designed for a specific application



Figure 0-3 Warning signs on adhesives

Adhesives also have a number of important terms associated with them:

- Cleanliness - Surfaces to be joined must be clean
- Cure - The process of setting often described as 'going off'.
- Wetting - This means that the adhesive spreads evenly and fully over the surface
- Thermo-setting - Meaning that heat is required to cure the adhesive.
- Thermo-plastic - Melts when heated.
- Contact adhesive - Makes a strong joint as soon as contact is made.

- 'Super glue' - Cyanoacrylate adhesive which bonds suitable materials in seconds, including skin - take care!



Loctite super glue

Adhesives have many advantages, which is why they are becoming more widely used. The following are some of the advantages:

- Even stress distribution over the whole surface.
- Waterproof
- Good for joining delicate materials
- No distortion when joining.
- A wide variety of materials can be joined.
- Neat, clean join can be made with little practice.



Interior of Honda Accord

As a final point in relation to adhesives I would stress the importance of choosing the correct type for the job in hand. For example an adhesive designed to bond plastic will not work

when joining rubber to metal. And don't forget, if the surfaces to be joined are not clean you will make a very good job of bonding dirt to dirt instead of what you intended!

SOLDERING

Soft soldering is a process used to join materials such as steel, brass, tin or copper. It involves melting a mixture of lead and tin to act as the bond. A common example of a soldered joint is the electrical connection between the stator and diode pack in an alternator. The picture shows this process using the most common heat source, which is an electric soldering iron.

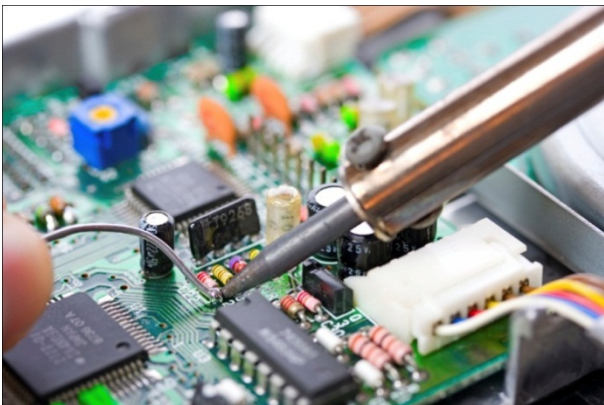

Soldering an electronic circuit

The process of soldering is as follows:

- Prepare the surfaces to be joined by cleaning and using emery cloth or wire wool as appropriate.
- Add a flux to prevent the surfaces becoming dirty with oxide when heated, or use a solder with a flux core.
- Apply heat to the joint and add solder so it runs into the joint.

- Complete the process as quickly as possible to prevent heat damage.
- Use a heat sink if necessary.

Soldering in common with many other things is easy after some practice; take time to do this in your workshop. Note that some materials such as aluminium cannot be soldered by ordinary methods.

BRAZING

Brazing is a similar process to soldering except a higher temperature is needed and different filler is used. The materials to be joined are heated to red heat and the filler rod (bronze brass or similar), after being dipped in flux, is applied to the joint. The heat from the materials is enough to melt the rod and it flows into the gap making a good strong, but slightly flexible joint. Dissimilar metals such as brass and steel can also be joined and less heat is required than when fusion welding. Brazing is only used on a few areas of the vehicle body.

WELDING

Welding is a method of joining metals by applying heat, combined with pressure in some cases. A filler rod of a similar metal is often used. The welding process joins metals by melting them, fusing the melted areas, and then solidifying the joined area to form a very strong bond. Welding technology is widely used in the automotive industry.



Welding in Process

The principal processes used today are gas and arc welding, in which the heat from a gas flame or an electric arc melts the faces to be joined. The picture shows a welding process in action.



MIG welding process

Several welding processes are used:

- Gas welding uses a mixture of acetylene and oxygen which burns at a very high temperature. This is used to melt the host metal with the addition of a filler rod if required. (OA or oxy-acetylene)
- Shielded metal-arc welding uses an electric arc between an electrode and the work to be joined; the electrode has a

coating that decomposes to protect the weld area from contamination and the rod melts to form filler metal (MMA or manual metal arc).

- Gas-shielded arc welding produces a welded joint under a protective gas (MIG or metal inert gas).
- Arc welding produces a welded joint within an active gas (MAG or metal active gas).
- Resistance welding is a method in which the weld is formed by a combination of pressure and resistance heating from an electric current (Spot welding).



TIG welding



MMA Welding

Other, specialised types of welding include laser-beam welding, which makes use of the intensive heat produced by a light beam to melt and join the metals and ultrasonic welding, which creates a bond through the application of high-frequency vibration while the parts to be joined are held under pressure.

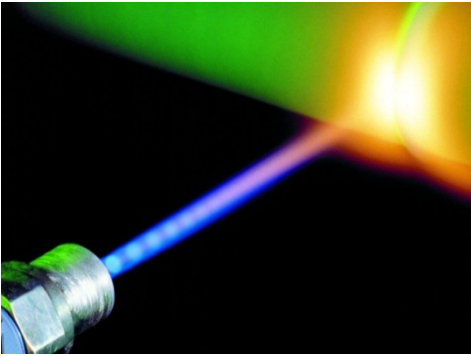

Laser-Beam Welding

SHRINKING

When parts are to be fitted by shrinking they first have to be heated so they expand, or cooled so they contract. In both cases the component to be fitted must be made to an exact size. If parts fitted in this way are to be removed, it is usual to destroy them in the process. For example, a flywheel ring gear has to be cut through with a hacksaw to remove it.

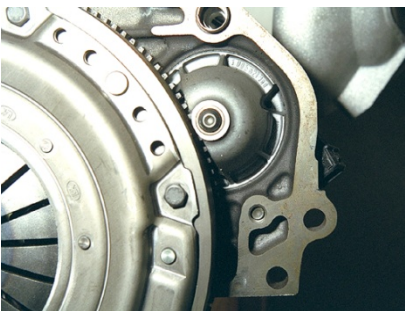

Ring gear on flywheel

For a hot shrink fitting the part will have a smaller internal diameter than the one on which it is to be fitted. It is important not to overheat the components or damage will occur. An oven is best, but a welding torch may be used with great care. When the component has been heated and therefore

expanded, it is placed in position at once. It will then cool and make a good tight joint.



Oxy-Acetylene Welding

Cold shrinking is very similar except the component to be fitted is made very slightly larger, than the hole in which it is to be fitted. A cylinder head valve insert is one example. The process is the opposite of hot shrinking. The component is cooled so it contracts, after which it is placed in position where it warms back up and expands, making a secure joint. Cold shrinking is normally a specialist job, but it is possible to buy aerosols of carbon dioxide under pressure which can be used to make a component very cold (dry ice).



Freeze Spray (Source: Maplin)

Compression Fitting

Many parts are fitted by compression or pressure. Bearings are the most common example. The key to compression fitting is an

interference fit. This means that the component, say a bearing, is very slightly larger than the hole in which it is to be fitted. Pressure is therefore used to force the bearing onto place. Suspension bushes are often also fitted in this way.



This bearing on a gearbox shaft is held in place by compression

The secret is to apply the force in a way which does not make the components go together on an incorrect angle. They must be fitted true to each other.

RIVETING

Riveting is a method of joining metal plates, fabric to metal or brake linings to the shoes. A metal pin called a rivet, which has a head at one end, is inserted into matching holes in two overlapping parts. The other end is struck and formed into another head, holding the parts together. This is the basic principle of riveting but many variations are possible.



Brake lining riveted to a shoe

The picture below shows some pop rivets, which are one of the most common for motor vehicle repair. These are hollow rivets which are already mounted on to a steel pin. The rivet is placed through the holes in the parts to be joined and a special rivet gun grips the pin and pulls it with great force. This causes the second rivet head to be formed and when the pin reaches a set tension it breaks off, leaving the rivet securely in place. The great advantage of this method is that you can work blind. In other words, you don't need access to the other side of the hole!



Pop rivets

GASKETS

Gaskets are used to make a fluid or pressure tight seal between two component faces. The best example of this is the cylinder head gasket which also has to withstand very high pressures and temperatures. Gaskets are often used to make up for less than perfect surfaces and therefore act as a seal between the two. Also as temperature changes, the gasket can take up the difference in expansion between the two components. Gaskets are made from different materials depending on the task they have to perform.

Gaskets and typical uses

Gasket material	Examples of where used
Paper or card	General purpose such as thermostat housings
Fibre	General purpose
Cork	Earlier type rocker covers
Rubber - often synthetic	Water pump sealing ring
Plastics - various types	Fuel pump to engine block
Copper asbestos - or similar	Exhaust flange - note safety issues of asbestos
Copper and aluminium	Head gaskets
Metal and fibre compounds - with metal composites	Head gaskets

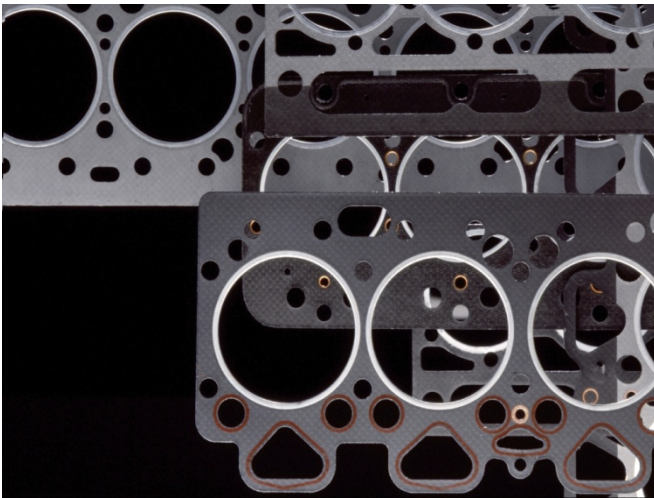

Figure 4 Cylinder head gaskets

The general rules for obtaining a good joint with a gasket or otherwise, are as follows:

- Cleanliness of the surfaces to be joined
- Removal of burrs from the materials

- Use of the correct materials
- Follow manufacturer's instructions (such as tighten to the correct torque in the correct sequence)
- Safe working (this applies to everything you do)

SEALANTS

Many manufacturers are now specifying the use of sealants in place of traditional gaskets. The main reason for this is a better quality of joint. Liquid sealants, often known as instant gasket, are a type of liquid rubber which forms into a perfect gasket as the surfaces are mated together. The three major advantages of this technique are:

- Easier to apply.
- A perfect seal is made with very small space being taken up.
- Adhesive bonding effect reduces fretting due to vibration and hence is less likely to leak.



Instant gasket

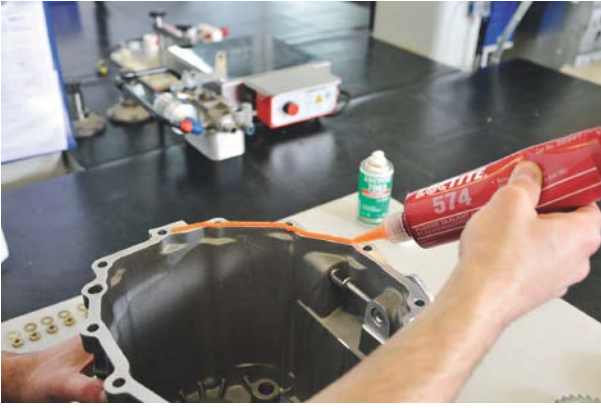

Loctite® Sealant (Source: © 2010 Henkel AG & Co. KGaA, Düsseldorf. All rights reserved)

The picture shows a sealant being applied. A major advantage as far as the repair trade is concerned is that a good selection of jointing sealants, means you can manufacture a gasket on the spot at any time! Note the recommendations of the manufacturers however as only the correct material must be used.

OIL SEALS

The most common type of oil seal is the neoprene (synthetic rubber) radial lip seal. The seal is fitted into a recess and the soft lip rubs against the rotating component. The lip is held in place by a spring. Figure x shows this type of seal, note how the lip faces the oil such that any pressure will cause the lip to fit tighter rather than allow oil to be forced underneath. Figure x shows a valve stem oil seal, which prevents oil entering the combustion chamber past the inlet valves.



Oil seals (Source: © 2005 Newsad Energy Company. All Rights Reserved)



Valve stem oil seal

 Look back over the previous sections and write out a list of the key bullet points here:

VALETING

OVERVIEW, EQUIPMENT AND SAFETY

Introduction When valeting a vehicle it is worth considering the reasons for such an operation. Why should a vehicle be presented to such a high standard? I suggest that there are three main reasons:

- It enhances the value of the vehicle
- A customer's first impressions are very important
- It simply looks good.

A vehicle will be valeted for a number of reasons:

- A request from a customer
- Preparation for sale
- Part of a vehicle service as an incentive to the customer

A wide range of cleaning products is available to assist with the valeting process.



Valeting products (Source: Autoglym)

Safety and PPE The products for vehicle valeting are chosen to do a job quickly and to a good standard but this must never be at the expense of safety. Let's start with the obvious safety recommendations and remember that safety precautions are for your benefit:

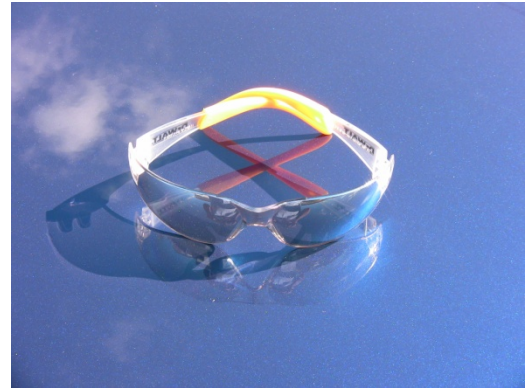

Safety glasses

- Only use a product for its intended purpose
- Store cleaning materials safely and away from children
- Use appropriate PPE
- Always follow manufacturers' instructions

Data sheets Detailed data sheets are available from the manufacturers on request. This is a requirement of the COSHH regulations.

Because of the job they have to do valeting products are made from strong chemicals, take extreme care.

The data sheet show here is

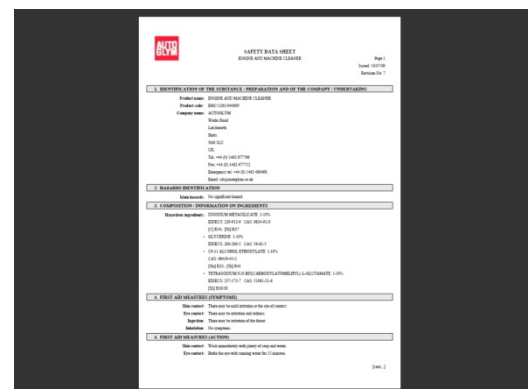

available from the Autoglym website.

Pressure washers Pressure washers can increase the water pressure from about 4 bar up to 100 bar. This can actually save water, as the washing process is much faster. Steam cleaners are similar except that they use high pressure and very high temperature water. The water is pressurized by an electric pump and heated by burning a fuel.



Pressure washer (Source: Kärcher)

Steam cleaner safety The potential for accidents is significant if safety procedures are not followed. The steam cleaner has the following safety risks:

- Very hot water - risk of burns or scalding
- High-pressure water - damage to the vehicle or eyes and ears for example
- Hot machinery - the heating



Steam cleaner (Source: Kärcher)

- coils get very hot and will burn
- Naked flames - burning paraffin is often used to create the hot water
 - Strong detergents - skin and eye damage
 - High voltage electrical supply - serious risk as it is in the vicinity of water
 - Metal lance - gets very hot but can also damage the vehicle paintwork

Polishing tools Polishing tools are useful for exterior cleaning. They can save a lot of time when polishing or buffing up. An important precaution however, is to take extra care that you do not damage the paintwork.



Polisher (Source: Craftsman Tools)

Interior cleaning equipment The main piece of equipment for interior cleaning is the wet vacuum cleaner. Water and suitable cleaning fluid is forced into the upholstery under pressure. A strong vacuum is then used to suck out the water and dirt. The water is collected in the machine for later disposal. Carpet cleaners used in the home are very similar. A normal but heavy-duty vacuum cleaner is also an essential interior cleaning tool.



Wet or Dry Vacuum (Source: Karcher)

Summary Remember, valeting:

Enhances the value of a vehicle

Makes a good first impression

Ensures that the car looks its best!

Always follow manufacturers' procedures when using cleaning solutions and equipment.



Look back over the previous section and write out a list of the key bullet points here:

EXTERIOR CLEANING

Cleaning the wheels The first step in washing a vehicle will often be to clean the wheels, tyres and wheel arches. If brake dust is allowed to remain on the wheel it can permanently bond with and etch the surface.

Follow the directions provided by the manufacturer. The wheel cleaner will often be sprayed on and worked in with a brush. Use a shampoo solution to remove the wheel cleaner. Make sure you do not allow the wheel cleaning solution to dry on the wheel and tyre surface. Some cleaning solutions will etch the wheel, if allowed to dry without rinsing. Thoroughly spray with water to rinse of all the cleaner to complete the job.

Washing the paint Washing the vehicle by hand with a bodywork shampoo is the best method. Do not use household detergents because they are made to remove grease. They will also remove the polish on the paint surface and accelerate the oxidation process. A pressure washer is an ideal tool to assist with washing.

Washing process To wash the vehicle:

1. Make sure that the paint surface is cool to the touch
2. Wash from the top down
3. Use either a natural fibre mitt or a shampoo sponge
4. Follow the instructions regarding the amount of shampoo to use
5. Wash the vehicle in small sections with frequent rinsing to prevent the water and the contaminants that you are removing from drying on the surface of the paint
6. Rinse your mitt or sponge frequently as you progress down the sides of the vehicle, since there is more dirt and contaminants closer to the ground
7. Finish with a complete rinse of the entire vehicle



Start at the top...



...and work down the sides



Rinsing

Drying There are five steps in the drying process to get the best results:

Remove the largest volume of the water from the entire vehicle with a chamois

Blow out all the channels where water can accumulate

Further dry all surfaces, including windows and wheels

Open all the doors, the engine compartment and the boot to eliminate any remaining run off and water tracks

Wind the windows down a little to clean any dirt from the seal area at the top and sides of the glass.

Inspection When the drying is complete you are ready to inspect the exterior surface. Depending on the condition of the paint, there are several different products that may be needed to produce an ideal finish.



Drying with a chamois leather



Checking and...

Examples of these include:

Wax and grease strippers

Solvents and cleaners

Tar and road oil removers

"Clay" - to remove paint overspray and other imbedded contaminants

Abrasives and glazes

Tar and road film removers These products are harsh on the paint surface and care should be taken. They should not remain on the surface over a few seconds. These products may soften the paint and cause discoloration.

Clay products These products are used to remove paint overspray from the paint surface. They should be used with caution, as they are designed to lift contaminants and carry them away from the paint surface in the clay material. These products can often remove overspray without resorting to loss of the paint



...inspecting the vehicle



Additional cleaning product in use



Clay kit (Source: Autoglym)

surface through use of compounds that contain abrasives. The clays may sometimes be used in conjunction with soapy water as a wetting agent for the gentle rubbing of the paint surface with the clay.

Abrasives compounds Caution - these products remove paint from the vehicle's surface. There is no way to put the paint back on when you go too far! The range of abrasive grit can be thought of as roughly comparable to wet and dry rubbing down paper. The types of paint damage that will require this product include heavy oxidation, serious water spotting, paint overspray that has bonded and several types of air pollution that contain acid components. In other words when the paint surface itself has been damaged. The normal procedure is to cover a small area with a back and forth motion. The product should not be allowed to dry and should be removed when it becomes cloudy or tacky. Take care!



Application to a small scratch

Polymers and waxes There are two main products for protecting automotive paint finishes:

- Polymers - synthetic, manmade substances
- Waxes - naturally occurring substances found in trees (and bees!)



Apply polish to the cloth

There is a much discussion regarding the merits of each product. The cost of most polymers will be higher than their counterpart waxes but polymers will last up to four times longer. This durability factor is a significant consideration. There is an edge to the polymers when comparing ease of use; they go on easier and come off faster. An additional benefit is the clarity and refractive consistency that the polymers produce on the finish surface. When comparing depth of gloss however, high quality waxes have an edge.

Finishing All finishing products should be applied in a front to back motion with a cotton cloth. The drying time can range from

minutes to days, to achieve maximum bonding for some polymers. I suggest a product that dries in a few minutes will be most appropriate for professional valeting.

All polymer and wax products should ideally be hand finished. However use of an orbital buffer with a high quality pad can reduce the effort of removal of the finish product. In all cases, the final step in removal should be by hand.

Glass cleaning Products, which contain ammonia, do a good job of removing the dirt and film that is found on vehicle glass. One of the main problems with cleaning the inside surfaces is the buildup of contaminants. These come from the decomposition of the vinyl and plastic components. This decomposition and transfer to the surface of the glass is caused by the ultra violet action of the sun.

It is recommended that two cotton cloths are used to clean and then dry the surface. Spray the cleaner on one cloth to prevent the cleaner from getting on the surface of the dashboard as you wipe the glass. Use the second towel to dry the surface.



Apply the cleaner to a cloth



Clean the glass and polish with a dry cloth

Clean the outside first as this makes it easier to see where there are any streaks when you do the interior.

Lower the door windows to get both sides of the glass, which is recessed, into the door.

Cleaning the engine First remove the debris that you will find in the channels of the body, bonnet and the grill openings. The best way to accomplish this job is with an air line. Next cover all electrical connections such as sensors, distributor, and spark plug openings with either plastic bags or film bags. Use tape to seal the plastic surrounding these connections to prevent water from reaching them if necessary.

Completely wet down the wings, grill, top and bottom of the bonnet and the entire engine compartment. A pressure washer is ideal, but not essential. It is important to wet down all painted surfaces that surround the engine compartment, because the degreaser solution that you will use



Before washing the engine check carefully...
...for areas that may be susceptible to water damage

for cleaning may strip the protective coatings on these surfaces.

Note that if the engine is to be cleaned, it will normally be done before the rest of the vehicle.

Engine degreaser A pressure tank sprayer or a spray bottle for application of this product is best. Engine cleaners work most effectively when all of the surfaces to be cleaned have received a thorough soaking. The product should be allowed to stay on the engine components for a few minutes but check the instructions on the container. Use of a brush on the engine and other surfaces may help to remove heavy oil deposits if you are not using a pressure washer.

To remove the engine cleaner, completely soak down the entire compartment and the surrounding surfaces. If you use a pressure washer be careful not to get the nozzle too close to any electrical



Engine cleaner

connectors. When the compartment has dried, spray on a rubber and plastic conditioner.

Rubber and plastic There are two causes of damage to exterior rubber and plastic surfaces:

- UV light
- Ozone

Most products that are designed to condition plastic and rubber have silicone as an ingredient. There is however some controversy regarding silicone as a component in both non-porous and porous surface conditioning. There are some people that believe that it will dissolve certain components in the rubber and cause cracking. It looks good when you first apply it though!

New car de-waxing When a new vehicle is delivered from the factory it is often protected with a type of wax or lacquer. This must be removed prior to the customer taking delivery.



Cleaning the plastic trim



Protective wax can be

There are two main types of protection often referred to as:

Hard wax

Soft wax

An appropriate solvent is used to soften the wax. The vehicle is then washed in the normal manner most often with a pressure washer or steam cleaner.

Summary Always follow manufacturers' instructions relating to cleaning products and equipment. Finally, remember to give the vehicle a last look over to ensure there are no small marks or smears, because you can be sure that these would be the first thing your customer will see!

removed with a solvent and a steam cleaner



The finished job



Look back over the previous section and write out a list of the key bullet points here:

INTERIOR CLEANING

Vinyl and leather After vacuuming use a cloth and a spray bottle for the application of an interior cleaner. Be careful to test a small area of the surface before you begin to make sure that the product will not produce any damage or significant colour removal.

Following cleaning, the conditioning step will be essentially the same process. In most cases the manufacturers will recommend buffing the conditioning product after it has had a few minutes to absorb into the surface. Regular cleaning and conditioning of vinyl and



A stained leather seat



Apply the cleaner

leather will extend the life of the product by a significant degree. It is particularly important to 'feed' leather regularly.

Carpet and upholstery products

Care should be taken when using products for cleaning carpets and upholstery, to ensure that the product will not cause any unwanted result such as colour removal. The surface should be thoroughly vacuumed both before and after use of a cleaner. The benefit of thorough re-vacuuming is that it will remove the contaminants that the cleaner has lifted from the surface. Most professional valeters will use a wet vacuum with a detergent in the water. The fluid is sprayed in to the upholstery under pressure and then vacuumed out.



Use a brush attachment for the dashboard area

Air fresheners There is a wide range of scents available in deodorants/air fresheners. An aerosol spray, directly on the surfaces that will absorb the product is a good idea. These surfaces include the carpet, floor mats and the cloth upholstery (not vinyl and leather). Don't select products that have an overpowering aroma!



Air freshener

Summary As usual, always follow manufacturers' instructions relating to cleaning products and equipment. Finally, remember to fit seat covers and protective mats, particularly if the seats are still a little damp!



Look back over the previous section and write out a list of the key bullet points here:

THE MOTOR TRADE

INTRODUCTION

This section will outline some of the jobs that are open to you in the motor trade and help you understand more about the different types of business and how they operate.

It is easy to think that the operation of a business does not matter to you. However, I would strongly suggest we should all be interested in the whole business in which we are working. This does not mean to interfere in areas we do not understand. It means we should understand that all parts of the business are important. For example, when you complete a job, enter all the parts used so the person who writes the invoice knows what to charge!



A Ford main dealer

The motor trade offers lots of opportunities for those who are willing to work hard and move forwards. There are many different types of job and you will find one to suit you with a little patience and study.

Ask your boss to give you a 'tour' of the garage so that you can appreciate the different tasks carried out and systems that are in place - in particular, make sure you get a reasonable idea about the words and phrases in the following table. If you do not yet have a job you may be able to arrange a visit.

Customer	The individuals or companies that spend their money at your place of work. This is where your wages come from
Job card	A printed document for recording amongst other things, work required, work done, parts used and the time taken
Invoice	A description of the parts and services supplied with a demand for payment from the customer
Company system	A set way in which things work in one particular company. Most motor vehicle company systems will follow similar rules but will all be a little different
Contract	An offer which is accepted and payment is agreed. For example, if I offer to change your engine oil for £15 and you decide this is a good offer and accept it, we have made a contract. This is then binding on both of us
Image	This is the impression given by the company to existing and potential customers. Not all companies will want to project the same image
Warranty	An intention that if within an agreed time a problem occurs with the supplied goods or service, it will be rectified free of charge by the supplier
Recording system	An agreed system within a company so that all details of what is requested and/or carried out are recorded. The job card is one of the main parts of this system
Approved repairer	This can mean two things normally. The first is where a particular garage or bodyshop is used by an insurance company to carry out accident repair work. In some cases however, general repair shops may be approved to

	carry out warranty work or servicing work by a particular vehicle or component manufacturer
After sales	This is a general term that applies to all aspects of a main dealer that are involved with looking after a customer's car - after it has been sold to them by the sales department. The service and repair workshop is the best example

TYPES OF MV COMPANIES

Motor vehicle companies can range from the very small one person businesses to very large main dealers. The systems used by each will be different but the requirements are the same.



One of the best known 'quick fit' companies

A system should be in place to ensure the level of service provided by the company meets the needs of the customer. The following list shows how diverse our trade is.

Mobile mechanics	Servicing and repairs at the owners' home or business. Usually a one-person company.
Bodywork repairers and painters	Specialists in body repair and paintwork.
Valeters	These companies specialise in valeting - which should be thought of as much more involved than getting the car washed. Specialist equipment and products are used and proper training is essential.

Petrol stations	These may be owned by an oil company or be independent. Some also do vehicle repair work
Specialised repairers	Auto-electrical, air conditioning, automatic transmission, and ICE systems are just some examples.
General repair workshop or independent repairer	Servicing and repairs of most types of vehicles not linked to a specific manufacturer. Often this will be a small business maybe employing two or three people. However, there are some very large independent repairers.
Parts supply	Many companies now supply a wide range of parts. Many will deliver to your workshop.
Fast-fit	Supplying and fitting of exhausts, tyres, radiators, batteries, clutches, brakes and windscreens.
Fleet operator (with workshop)	Many large operators such as rental companies, will operate their own workshops. Also a large company that has lots of cars, used by sales reps for example, may also have their own workshop and technicians.
Non-franchised dealer	Main activity is the servicing and repairs of a wide range of vehicles, with some sales.
Main dealers or Franchised dealers	<p>Usually franchised to one manufacturer, these companies hold a stock of vehicles and parts. The main dealer will be able to carry out all repairs to their own type of vehicle as they hold all of the parts and special tools. They also have access to the latest information specific to their franchise (Ford or Citroen for example).</p> <p>A 'franchise' means that the company has had to pay to become associated with a particular manufacturer but is then guaranteed a certain amount of work and that there will be no other similar dealers within a certain distance.</p>
Multi-	This type of dealer is just like the one above - except

franchised dealer	they hold more than one franchise - Volvo and Saab for example.
Breakdown services	The best known breakdown services are operated by the AA and the RAC. Others include National Breakdown and of course many independent garages also offer these roadside repair and recovery services.
Motorists shops	Often described as motorist discount centres or similar, these companies provide parts and materials to amateurs but in some cases also to the smaller independent repairers.



An independent garage and car sales business

COMPANY STRUCTURE

A larger motor vehicle company will probably be made up of at least the following departments:

- Reception
- Workshop
- Bodyshop and paint shop
- Parts department
- MOT bay
- Valeting
- New and second user car sales
- Office support
- Management
- Cleaning and general duties

Each area will employ one or a number of people. If you work in a very small garage you may have to be all of these people at once! In a large garage it is important that these different areas communicate with each other to ensure that a good service is provided to the customer. The main departments are explained further in the following sections.

ROLE OF A FRANCHISED DEALER

The role of a franchised dealer is to supply local:

- new and used franchised vehicles
- franchise parts and accessories
- repair and servicing facilities for franchise vehicles.

The dealer is also a source of communication and liaison with vehicle manufacturer.



A "motorists' discount" shop

RECEPTION AND BOOKING SYSTEMS

The reception whether in a large or small company is often the point of first contact with new customers. It is very important therefore to get this bit right. The reception should be manned by pleasant and qualified persons. The purpose of a reception

and booking system within a company can be best explained by following through a typical enquiry.

- The customer enters reception area and is greeted in an appropriate way.
- Attention is given to the customer to find out what is required (Let's assume the car is difficult to start, in this case).
- Further questions can be used to determine the particular problem, bearing in mind the knowledge of vehicles the customer may, or may not have, (Is the problem worse when the weather is cold for example).
- Details are recorded on a job card about the customer, the vehicle and the nature of the problem. If the customer is new a record card can be started, or continued for an existing customer.
- Explanation of expected costs is given as appropriate. An agreement to only spend a set amount, after which the customer will be contacted, is a common and sensible approach.
- Date and time when the work will be carried out can now be agreed. This depends on workshop time availability and when is convenient for the customer. It is often better to say you cannot do the job until a certain time, rather than make a promise you can't keep.

- The customer is thanked for visiting. If the vehicle is to be left at that time, the keys should be labelled and stored securely.
- Details are now entered in the workshop diary or loading chart (usually computer based).

The above list is an example. Your company may have a slightly different system but you can now see the approach that is required.



Small specialist companies are often located in units similar to those shown here

PARTS DEPARTMENT

The parts department is the area where parts are kept and ordered! This will vary quite a lot between different companies. Large main dealers will have a very large stock of parts for their range of vehicles. They will have a parts manager and in some cases several other staff. In some very small garages the parts department will be a few shelves where popular items such as filters and brake pads are kept.

Even though the two examples given above are rather different in scale the basic principles are the same and can be summed up very briefly as follows:

- A set level of parts or stock is decided upon.
- Parts are stored so they can be easily found.
- A reordering system should be used to maintain the stock.

Security is important as most parts cost a lot of money. When parts are collected from the parts department or area, they will be for use in one of three ways:

- For direct sale to a customer.
- To be used as part of a job.
- For use on company vehicles.

In the first case an invoice or a bill will be produced. The second case, the parts will be entered on the customer's job card. The third case may also have a job card or if not some other record must be kept. In all three cases keeping a record of parts used will allow them to be reordered if necessary. If parts are ordered and delivered by an external supplier, again they must be recorded on the customer's job card.

Communication

There are several sources of information available to help a technician carry out his or her work. It is not necessary to remember everything - but it is necessary to remember where to look up everything! The most common sources of information are listed here:

- *Vehicle and equipment manuals*
- *Parts lists*
- *Computers*

- *Data books*
- *Diagnostic equipment*
- *Internet*
- *CD/DVD-ROM*
- *Manufacturers*

Main dealers are supplied with information by the manufacturers. Independent repairers often use companies such as Autodata

ESTIMATING COSTS AND TIMES

When a customer brings his or her car to a garage for work to be carried out, quite understandably he or she will want to know two things:

1. How much will it cost?
2. When will it be ready?

In some cases such as for a full-service, this is quite easy as the company will have a set charge and by experience will know it takes a set time. For other types of job this is more difficult.

Most major manufacturers supply information to their dealers about standard times for jobs. These assume a skilled technician with all the necessary tools. For independent garages a publication known as the ICME manual is available. This gives agreed standard times for all the most common tasks, on all popular makes of vehicle.

To work out the cost of a job, you look up the required time and multiply it by the company's hourly rate. Don't forget the cost of parts will also need to be included.

JOB CARDS AND SYSTEMS

The job card is a vital part of the workshop system in a motor vehicle company. Many larger companies may dispense with the 'paper' altogether and use computer systems. These are more expensive to install but allow very fast, easy and accurate communication. Whether job cards or IT systems are used the principle is the same and consists of a number of important stages. This is often described as the four-part job card system:

1. Reception - Customers details and requirements are entered on the job card or computer screen.
2. Workshop control - Jobs are allocated to the appropriate technician using a loading sheet or again via the computer.
3. Parts department - Parts used are added to the computer or job card.
4. Accounts - Invoices are prepared from the information on the job card. Computerised systems may automatically produce the invoice when the job is completed.

JOB CARD					
Driver Name & Address	Job Number	Technician Name			
Contact No.					
Account No.	Order No.	Department	Dealer	Date Last Visit	
Type	Make/Model	Reg. Date	Chassis/VIN No.	Reg. No.	
Colour/Fin	Engine	Manually	Date In	Date/Time Out	
Customer's Instructions		Message	Flat Reading	8" 12" 16" 20" F	
		Fuel Pressure	High Pressure		OK
		Consumable Used			OK
		Make a note of any damage to the vehicle bodywork.			
					
I agree to the above work being undertaken.					
Customer Signature					

Work Carried Out	Time Taken
Total	
Parts Used	Price
Total	
Data and Specifications Used (include the actual figures)	
Total	
Repair	Assistant name, signature and date

An example job card

When a computer system is used each terminal will pass information to all the others. With job cards either the same card must be carried to each stage or copies are kept in each area. The different copies are collected and combined to produce the invoice.

INVOICING

As part of the contract made with a customer, an invoice for the work carried out is issued. The main parts of an invoice are as follows:

- Labour charges - the cost of doing the work. Usually the time spent times the hourly rate.
- Parts - The retail price of the parts or as agreed.
- Sundries - Some companies add a small sundry charge to cover consumable items like nuts and bolts or cable ties etc.

- MOT test - If appropriate. This is separated because VAT is not charged on MOTs.
- VAT - Value Added Tax - At the current rate, if the company is registered (all but the very small are).

Hourly rates vary quite a lot between different garages. The hourly rate charged by the company has to pay for a lot more than your wages - hence it will be much higher than your hourly rate! Just take a look round in any good workshop, as well as the rent for the premises, some of the equipment can cost tens of thousands of pounds. The money has to come from somewhere.

Percentages

Percentages are really just simple fractions of a hundred - per cent actually means of a hundred

If a bonus scheme at work increases your hourly rate by 28%, let's work out how much you will get!

Assume your normal pay rate is £8 per hour.

$$28\% = \frac{28}{100}$$

$$\frac{28}{100} \times £8 = \frac{224}{100} = £2.24$$

(224 is 28 x 8)

Your new pay rate is £8 + £2.24p which is £10.24 per hour - I hope this is what you get!

COMPUTERISED WORKSHOP SYSTEM

Introduction There are a number of computer based workshop management systems available. Some are specifically designed for main dealers, some for the smaller independent company. In this section I will outline a system called GDS Workshop Manager as it is designed for the smaller company yet includes some very powerful features and can be used in larger operations.

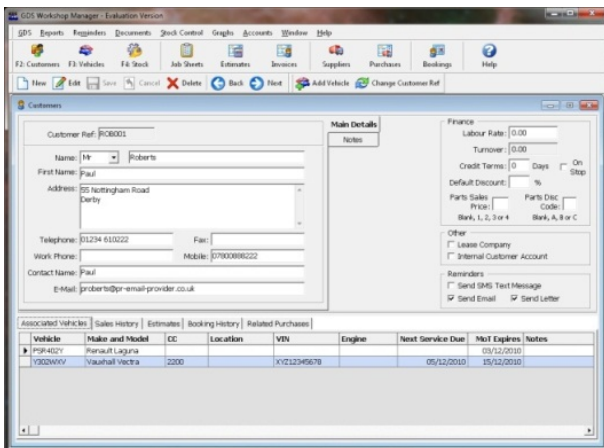

Main interface of the GDS program showing the customers screen

Features The main features of this system are shown in the list on this screen.

- Storage of all customer, vehicle and supplier details
- Production of jobsheets (job cards), estimates, and sales invoices
- Creation of documents using menu priced jobs
- Invoices that can be split into insurance/excess invoices

- Internal billing and cost tracking facilities
- Purchase invoices and stock control
- Diary/booking planner
- MOT and service reminders
- Vehicle registration mark lookup facility
- Repair times and service schedules option

There are many other features relating to accounts and reports that are beyond the scope of this book but are very useful for managing a business.

New record process The core of this and other systems is the data that is held about customers, their vehicles and the work carried out on them. New records can be created from a number of points within the system. The following would be typical of a process:

1. A new customer has a problem with their car and requests an estimate
2. Customer and vehicle details are added, with the help of post code and vehicle registration look-up features
3. The estimate is now created, with the use of repair times look up if needed, and can be printed
4. The customer agrees the price and the vehicle is booked in using the booking screen
5. On the agreed date a jobsheet is printed (or accessed on screen) and the designated technician carries out the work adding parts and comments as needed. A service schedule may also be accessed at this point.

6. An invoice is created and printed (or emailed)
7. And, in an ideal world, the customer pays as they collect the vehicle.

Jobsheet The above process is just one way the system can be used, for example the starting point could be creation of the jobsheet or an invoice. However, in all cases, customer and vehicle details must be added or updated. Existing customer and vehicle records can be easily looked up making the process of creating an invoice or whatever, much faster.

Jobsheet screen

Invoice The invoice details screen can have lines of detail grouped into relevant sections, such as Parts, Labour, MOT etc., as required. Sections can be created and stored as menu jobs to automatically fill in an invoice with often used descriptions, quantities and prices. Invoices can automatically update stock quantities for stock Items. Individual items on the invoice can also be linked to customers in order to aid part warranty checks in the future. Purchased parts can be added directly to a sales

invoice which maintains a link to the purchase invoice for future reference.

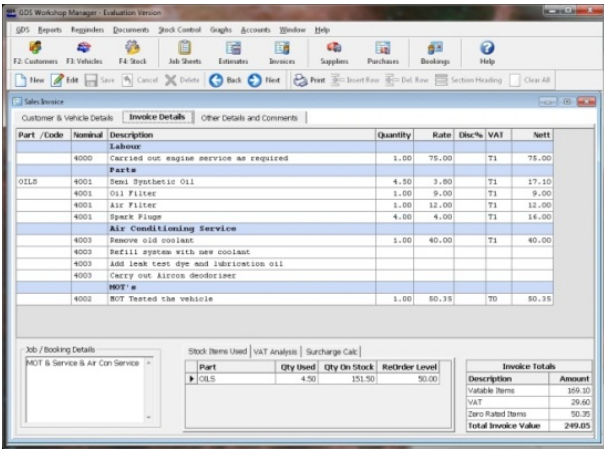

Sales invoice screen

Service schedules GDS Workshop Manager can optionally include a repair times and service schedules database which can be incorporated directly into the system. Vehicle times and service schedules can be looked up as required, or accessed from within the jobsheet, estimate and invoice screens to allow times to be automatically entered directly onto document being worked on. Service schedules for cars and light commercial vehicles can be printed.

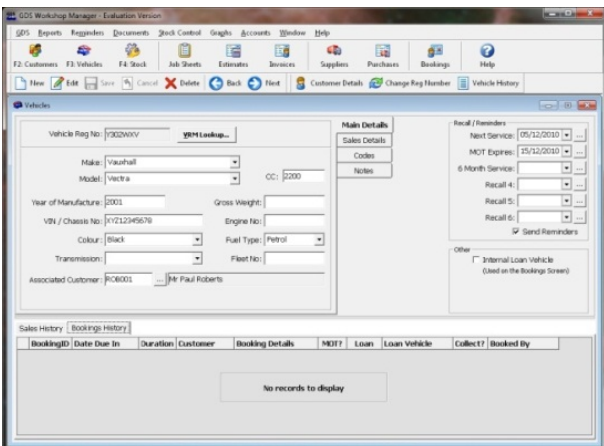

Vehicles screen

Summary A computer based workshop management system allows the easy creation of all the documentation needed for efficient workshop operation and management. It is now an essential part of a modern garage's tool kit. More information is available from: www.GarageDataSystems.com

The motor trade assignment

1. Draw a simple line diagram to show the structure of a typical main dealer

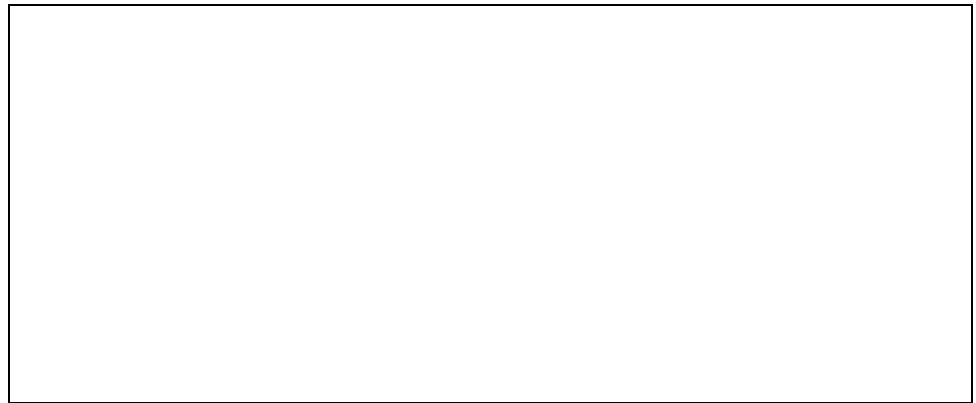

2. State **five** different types of motor trade business

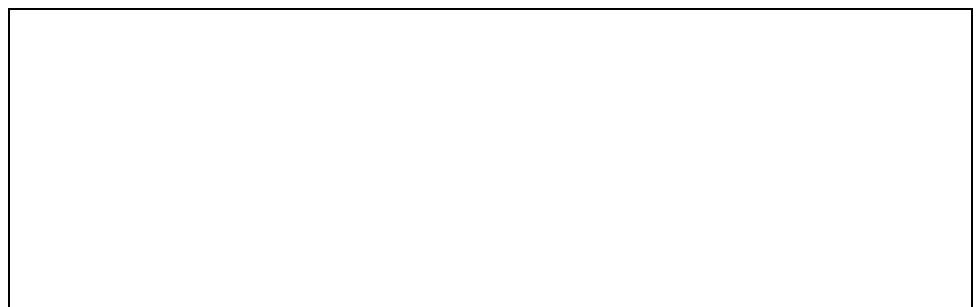

3. Outline the process that takes place in service reception

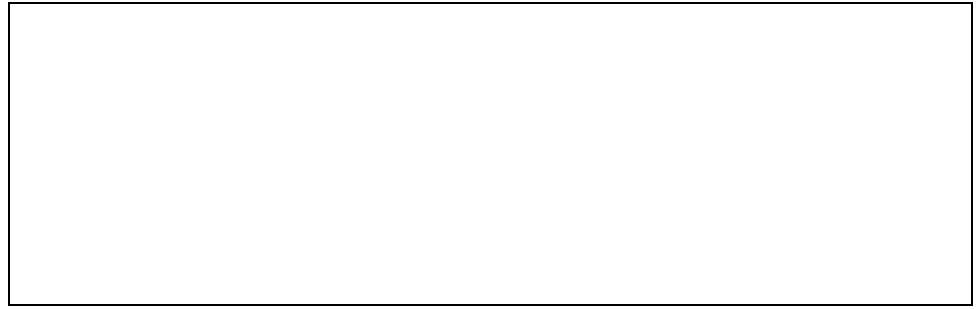

Quiz Questions

A normal franchised dealer specialises in

- a) all makes
- b) one make
- c) two or more makes
- d) no makes

When a job card is written up it should note

- a) only the parts used
- b) only the labour charges
- c) sundries and parts
- d) sundries, parts and labour

The term used to describe all the departments that a customer will be associated with when they have bought a vehicle is

- a) post sales
- b) after sales
- c) workshop services
- d) parts and service

A multi-franchised dealer will be associated with a number of

- a) Fleet customers
- b) body and paint departments
- c) parts suppliers
- d) manufacturers

The first point of contact for a customer after buying a car, in a large garage, is most likely to be the

- a) body shop after their first accident
- b) service reception
- c) complaints department
- d) sales area

A service receptionist will usually be responsible for

- a) sales servicing
- b) sales leads
- c) workshop loading
- d) workshop cleaning

The most reliable source of information for service and repair work is

- a) your workmate
- b) the manufacturer
- c) Google
- d) the workshop foreman

Some job cards are described as

- a) one-part
- b) two-part
- c) three-part
- d) four-part

The definition: "Fit for the purpose for which it was sold." is used to describe a

- a) warranty
- b) quality level
- c) guarantee
- d) sales pitch

One area that fast-fit companies specialise in is

- a) breakdowns
- b) discount parts
- c) exhausts
- d) transmissions

WARRANTIES

When a vehicle is sold a warranty is given meaning that it is fit for the purpose for which it was sold. Further to this, the manufacturer will repair the vehicle at no cost to the customer, if a problem develops within a set time. For most vehicles this is twelve months but some are now longer. The term generally used for this is 'guarantee'. Quite often manufacturers advertise their guarantee as a selling point.

It is also possible to have a warranty on a used vehicle or an extended warranty on a new vehicle. These often involve a separate payment to an insurance company. This type of warranty can be quite good but a number of exclusions and requirements may apply. Some examples are listed:

- Regular servicing at an approved dealer.
- Only recommended parts must be used.
- Wear and tear is not included.
- Any work done must be authorised.
- Only recognised repairers may be used in some cases.

The question of authorisation before work is carried out is very important for the garage to understand. Work carried out without proper authorisation will not be paid for. If a customer returns a car within the warranty period then a set procedure must be followed.

- Confirm that the work is within the terms of the warranty.
- Get authorisation if over an agreed limit (Main dealers have agreements with manufacturers).
- Retain all parts replaced for inspection.
- Produce an invoice which relates to standard or agreed times.

Often in the larger garages one person will be responsible for making warranty claims.

BACKGROUND STUDIES

INTRODUCTION

START HERE!

When you want to work on motor vehicles, why should you study maths, science, materials, electricity and other similar things? The information presented here is to help you learn and understand the basic principles so that you can be a better technician because you know how things really work.

TERMINOLOGY

Often the words used to describe scientific principles can be confusing. The following table picks out the most important and a simple explanation is given. Some of these terms are described in more detail in later sections.

SI units	A set of standard units so we all talk the same language. 'SI' stands for 'Système International'. This is French for 'International System'!
Ratio	The amount of one thing compared to another. E.g. two to one is written as 2:1
Area (m ²)	Amount of surface of anything. E.g. surface area of a car bonnet would help you know how much paint would be needed to cover it.
Volume (m ³)	Capacity of an object. E.g. 1000 cc (cubic centimetres) or one litre of paint to do the job above.
Mass (kg)	The quantity of matter in a body. Volume does not matter E.g. which has the greater mass, a kilogram of lead or a kilogram of feathers? They are both the same of course, but have different volumes.

Density (kg/m ³)	A full paint tin has a greater mass than an empty tin but the volumes are the same.
Energy (J)	The ability to do work or the amount of work stored in something. Petrol for example contains a lot of energy in chemical form.
Force (N)	When you push an object it moves (if you can apply enough force).
Work (J)	Work is done when the force applied to an object makes it move. Work can also be said to be done when energy is converted from one form to another.
Power (W)	The rate at which work can be done. E.g. energy used per second.
Torque (Nm)	A turning force like a spanner turning a nut. A longer spanner needs less force.
Velocity (m/s)	A scientific name for speed. E.g. the UK national velocity limit is 70 mph (not an SI unit!).
Acceleration (m/s ²)	The rate at which velocity changes. If positive then the car, for example will increase in speed. If negative (or deceleration) such as when braking, the car speed decreases.
Momentum (kg.m/s)	The combination of the mass of a body and its velocity. A large goods vehicle has much greater momentum than a car at the same speed. It must have much better brakes or it will take a lot longer to stop.
Friction (μ)	When one surface moves over another friction tries to stop the movement. It is interesting to note that without friction a moving object such as a car would not stop!
Heat (J)	This is a measure of the amount of energy in a body. Heat can only transfer from a higher to a lower temperature and this will be by conduction, convection or radiation.
Temperature (°C)	A measure of how hot something is but this must not be confused with the amount of heat energy.
Pressure (N/m ² or Pa)	This is a force per area. E.g. the old tyre pressure measurement was for many cars 28 psi. (Pound per square inch). The better units to get used to are bars, the tyre

	<p>pressure would be about 1.8 bar. The SI unit is the Pascal or Newtons per metre squared (Pa or Nm²). The pressure in this room is about 1 bar or 1 atmosphere or 100 000 Pa. It may be much more if you have been reading about science for a long time!</p>
Centrifugal force (N)	<p>If you swing a stone on a string round your head it tries to move outwards and you can feel the centrifugal force on the string. The faster you swing it the greater the force. When a car wheel is rotating very quickly a small imbalance in the tyre causes unequal centrifugal force and this makes the wheel wobble.</p>
Weight (N)	<p>The mass of an object acted upon by the earth's gravity give it a weight. When you next go into outer space, you will find that your weight is zero or in other words you are weightless. You do still have the same mass however. The word weight is often used incorrectly but as gravity is the same all over the earth it doesn't often make any difference.</p>
Centre of Gravity	<p>The point within an object at which it will balance. All the weight of an object such as a car can be said to act through the centre of gravity. If the force due to gravity and acceleration acting through this point, falls outside the wheels of the car, the car will fall over!</p>
Electricity	<p>This is the movement of electrons known as a current flow in a conductor or a wire. Electricity is a very convenient way of transferring energy.</p>
Strength	<p>This is hard to define because different materials are strong in different ways. A material can be strong (provide opposition to) bending, tension, compression or shear force.</p>
Corrosion	<p>Corrosion of materials is by a chemical process. E.g. if iron is left open to the air or water it rusts. The chemical process is that the iron is reacting with oxygen in the air and turning into iron oxide or rust.</p>
Machines	<p>A machine is something which converts one form of</p>

	energy into another. An alternator for example converts mechanical energy from the engine into electrical energy.
Hydraulics	When fluids are used to do 'work' this is described as hydraulics. The braking system of a car is a good example.
Oscillation	If you bounce a mass on a spring (a car on its suspension) it will move up and down (oscillate) until all the mechanical energy in the spring has been converted to another form (mostly heat due to friction). Dampers are used on a car to make this time as short as possible.

UNITS

When I go into a cafe or a pub and I ask for a pint of beer or half a litre of coke. I usually get what I want. This is because I ask by using the correct units. When you blow up the tyres on a car you check the pressure in a book or on a chart and then look at the gauge. It will have the same units, and you can inflate to the correct pressure.



The best and easiest units to work with are what are known as SI units; sometimes described as the metric system. The basic SI units you will need are as follows:

Unit	Abbreviation	Quantity	Example
metre	m	length	The distance from one point to another
kilogram	kg	mass	The quantity of matter which makes an object
second	s	time	About 300s to boil an egg!
Ampere	A	electric	The flow rate of electricity

		current	through a wire
Kelvin	K	temperature	How hot the radiator of a car is
candela	cd	luminous intensity	How bright a headlight shines

Many other units in use are derived from the basic SI units. Some of them are combined and given new names::

Unit	Abbreviation	Quantity
joule	J	energy
Newton	N	force
watt	W	power
area	m ²	square metres
volume	m ³	cubic metres
torque	Nm	Newton metres
velocity	m/s or ms ⁻¹	metres per second
acceleration	m/s/s or ms ⁻²	metres per second per second

When dealing with units we need a way of describing very large or very small quantities. For example I would not say that I live 24 000 metres away from where I work. I would say I live 24 kilometres away, normally written as 24 km. The 'k' is known as a multiplier and in this case you will see it has the value of 1000.

Likewise if setting a spark plug gap I could set it at 0.001 metres or it might be easier to say 1 millimetre, normally written as 1 mm. The 'm' can be thought of as a divider which in this case is 1000 or a multiplier of 0.001. The list of the common multipliers is as follows:

Prefix	Symbol	Value	Long value
mega	M	10^6	1 000 000
kilo	k	10^3	1 000
hecto	h	10^2	100
centi	c	10^{-2}	0.01
milli	m	10^{-3}	0.001
micro	μ	10^{-6}	0.000 001



Look back over the previous section and write out a list of the key bullet points here:

SCIENCE

INTRODUCTION

The following sections explain some scientific terms and principles in a little more detail than the previous tables. The figures with some sections show the principle as a picture.

VELOCITY & ACCELERATION

Velocity is the speed of an object in a given direction. Velocity is a 'vector quantity', this means its direction is important as well as its speed. The velocity v , of an object travelling in a fixed direction may be calculated by dividing the distance s , it has travelled by the time taken t .

$$\text{velocity} = \text{distance travelled}/\text{time taken} \quad (v = s/t)$$

Acceleration is the rate of change of velocity (how quickly speed is increasing or decreasing). It is usually measured in metres per second per second. Newton's second law of motion says that a body will accelerate only if it is acted upon by an outside force. The outside force on a car is either the accelerator to increase speed (accelerate) or the brakes to decrease speed (decelerate).

Acceleration due to gravity is the acceleration of an object falling due to the Earth's gravity. The value used for gravitational acceleration g , is 9.806 ms^{-2} (10 ms^{-2} is usually near enough for our calculations).

The average acceleration a , of an object travelling in a straight line over a time t , may be calculated using the formula:

- acceleration = change of velocity/time taken
- or, if v is its final velocity and u its initial velocity:
- $a = (v - u)/t$

A negative answer (less than zero like -2) would mean that the object is slowing down (decelerating).

FRICTION

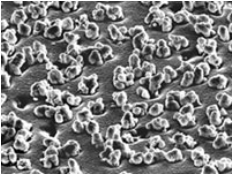

The force that opposes the relative motion of two bodies in contact is known as friction. The coefficient of friction is the ratio of the force needed to achieve this motion, to the force pressing the two bodies together.

For motor vehicle use friction is greatly reduced in some places by using lubricants such as oil and grease. In other places friction is deliberately increased - for example, brake shoes, pads, drive belts and tyres.

PRESSURE

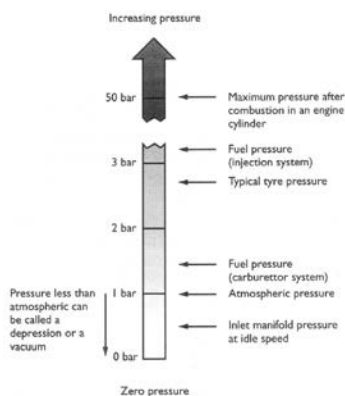

In a fluid or gas, pressure is said to be the force that acts at right angles per unit surface area of a something immersed in the fluid or gas. The SI unit of pressure is the Pascal (Pa), equal

to a pressure of one Newton per square metre. In the atmosphere, the pressure decreases as you go higher, from about 100 kPa at sea level to zero, where the atmosphere dwindles into space. The other common unit of pressure you will meet is the bar. One bar (100 kPa), is atmospheric pressure.

Absolute pressure is measured from a perfect vacuum or zero pressure. Gauge pressure is the difference between the measured pressure and atmospheric pressure. A tyre gauge works like this because it reads zero in atmospheric pressure. When we talk about a vacuum or a depression, what we really mean is a pressure less than atmospheric. It is best to use absolute pressure figures for discussing subjects such as the operation of an engine.

CENTRE OF GRAVITY OR CENTRE OF MASS

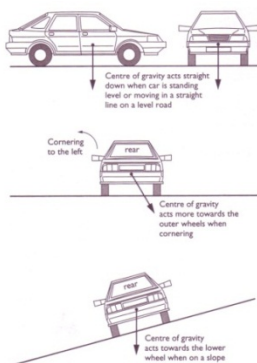

Point in (or near) to an object about which it would turn if it could rotate freely. A symmetrical object such as a cube or ball, has its centre of mass at its geometrical centre; a hollow object such as a glass, may have its centre of gravity in the space inside it.

For an object such as a car to be stable, a perpendicular line down through its centre of gravity must run within the boundaries of its wheel base. If the car is tilted until this line falls outside the wheel base, it will become unstable and fall over!

OSCILLATION

An oscillation is one complete to-and-fro movement of a vibrating object or system. For any vibration, the time for one complete oscillation is its time period. The number of oscillations in one second is its frequency. In most mechanical systems in the car, oscillations are damped down. The dampers fitted to the suspension help to prevent the springs oscillating.

ENERGY, WORK AND POWER

Energy can be thought of as the ability to do work or the amount of work stored up, it is measured in joules. When you have no energy it's hard to work! Energy cannot be destroyed, only converted to another form. It can be stored in a number of forms. Most types are listed together with an example:

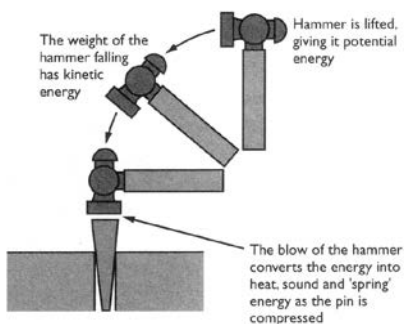

Kinetic or mechanical energy like the movement of an engine

Potential or position energy, when you lift a hammer its potential energy increases

Electrical energy such as that made by an alternator

Chemical energy stored in a battery

Heat energy from burning something

Nuclear energy which is not yet used on vehicles, fortunately!

Power is the rate of doing work or converting energy. It is measured in Watts. If the work done or energy consumed is E joules in t seconds, then the power P is calculated by:

$$\text{Power} = \text{work done} / \text{time} \quad P = E/t$$

FORCE AND TORQUE

A force is thought of as any influence that tends to change the state of rest or the motion in a straight line of an object. Just like braking force slows a vehicle down. If the body can't move freely it will deform or bend. Force is a vector quantity which means it must have both size and direction, its unit is the Newton N.

Torque is the turning effect of force on an object. A car engine produces a torque that the wheels. Torque is measured by

multiplying the force by its perpendicular distance from the turning point its units therefore are Newton metres, Nm.

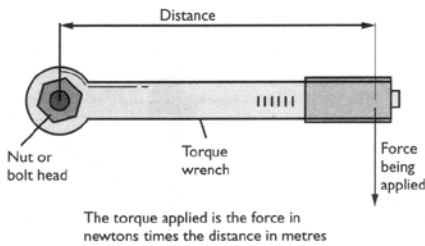

MASS, WEIGHT AND FORCE

Mass is the quantity of matter in a body as measured by its resistance to movement. The SI system base unit of mass is the kilogram kg. The mass of an object like a car, determines how much driving force is needed to produce a certain acceleration. The mass also determines the force exerted on a body by gravity. The force F , mass m , and acceleration a , (or g , if due to gravity) can be calculated by using:

$$\text{Force} = \text{mass} \times \text{acceleration} \quad F = ma \text{ (or)}$$

$$\text{Force} = \text{mass} \times \text{gravity} \quad F = mg$$

At a given place, equal masses experience equal gravity, which are known as the weights of the bodies. Masses can be compared by comparing the weights of bodies at the same place.

VOLUME AND DENSITY



Density is a measure of the compactness of a substance; it is measured in kg per cubic metre. The density D , of a mass m , occupying a volume V , is given by:

$$\text{Density} = \text{mass} / \text{Volume} \quad D = m/V$$

Relative density is the ratio of the density of a substance to that of water. This is useful for testing older types of battery by comparing the density of the electrolyte to that of water.

HEAT AND TEMPERATURE

Heat is a form of energy possessed by a substance by virtue of the vibrating movement, or kinetic energy of its molecules or atoms. Heat only flows from a higher temperature to a lower temperature. Its effect on a substance may be simply to raise its temperature, or to cause it to expand. Solids can melt, liquids vaporise and gasses if confined will increase in pressure. This is much like ice, water, steam and steam pressure in a boiler.

Quantities of heat are usually measured in units of energy, such as joules J . The specific heat of a substance is the ratio of the amount of heat energy required to raise the temperature of a given mass of the substance through a given range of

temperature, to the heat required to raise the temperature of an equal mass of water through the same range. This is useful for comparing materials.

Heat energy is transferred by conduction, convection, and radiation. Conduction is the passing of heat along a medium to neighbouring parts. For example, the whole length of a metal rod becomes hot when one end is held in the flame of a welding torch. Convection is the transmission of heat through a liquid or gas in currents, for example, when the air in a car is warmed by the heater matrix and blower. Radiation is heat transfer by infrared rays. It can pass through a vacuum and travels at the speed as light! For example, you can feel radiated heat from a vehicle headlight just in front of the glass.



Look back over the previous section and write out a list of the key bullet points here:

ELECTRICITY

ELECTRONS AND THINGS

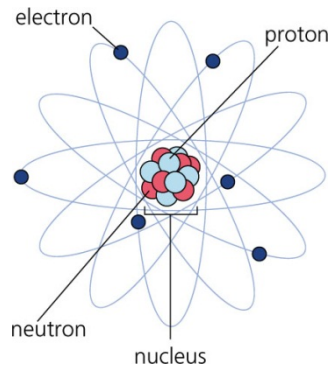
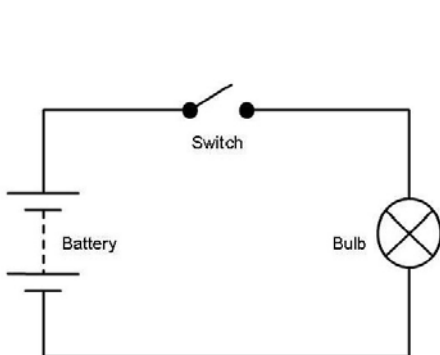

To understand electricity properly we must start by finding out what it really is. This means we must think very small! The molecule is the smallest part of matter that can be recognized as that particular matter. Sub-division of the molecule results in atoms. The atom is the smallest part of matter. An element is a substance, which comprises of atoms of one kind only.

The atom consists of a central nucleus made up of protons and neutrons. Around this nucleus electrons orbit, a bit like planets around the sun. The neutron is a very small part of the nucleus. It has an equal positive and negative charge. It is therefore neutral and has no polarity.

The proton is another small part of the nucleus, it is positively charged. As the neutron is neutral and the proton is positively charged, this means the nucleus of the atom is positively charged.

The electron is an even smaller part of the atom, and is negatively charged. It orbits the nucleus and is held in orbit by

the attraction of the positively charged proton on it. All electrons are similar no matter what type of atom they come from.

When atoms are in a balanced state the number of electrons orbiting the nucleus equals the number of protons. The atoms of some materials have electrons which are easily detached from the parent atom and join an adjacent atom. In so doing they move an electron (like polarities repel) from this atom to a third atom and so on through the material. This is a random movement. These are called free electrons

Materials are called conductors if the electrons can move easily. In some materials it is extremely difficult to move electrons from their parent atoms. These materials are called insulators.

ELECTRON FLOW OR CONVENTIONAL FLOW

If an electrical pressure (electromotive force or voltage) is applied to a conductor, a directional movement of electrons will take place (like connecting a battery to a wire).

Conditions for an electron flow:

- A pressure source, e.g. from a battery or generator.
- A complete conducting path for the electrons to move e.g. wires.

An electron flow is termed an electric current. For example, a battery positive terminal is connected, through a switch and lamp, to the battery negative terminal. With the switch open

the chemical energy of the battery will remove electrons from the positive terminal to the negative terminal via the battery. This leaves the positive terminal with less electrons and the negative terminal with a surplus of electrons. An electrical pressure or electromotive force (emf.) exists between the battery terminals.

With the switch closed the surplus electrons on the negative terminal will flow through the lamp back to the electron deficient positive terminal. The lamp will light and the chemical energy of the battery will keep the electrons moving in this circuit from negative to positive. This movement from negative to positive is called the electron flow.

However it was once thought that current flowed from positive to negative. This convention is still followed for practical purposes and will be used throughout this and other books. So even though it is not correct, the most important point is that we all follow the same convention. We say:

Current flows from positive to negative.

In the circuit mentioned above, whilst the switch was closed the chemical energy of the battery was first converted to electrical energy, and then to heat energy in the lamp filament.

EFFECTS OF CURRENT FLOW



When a current flows in a circuit it can produce only three effects.

- Heat
- Magnetism
- Chemical.

The heating effect is the basis of electrical components such as lights and heater plugs. The Magnetic Effect is the basis of relays and motors and generators.

The Chemical Effect is the basis for electroplating and battery charging. The above three effects are reversible. Heat applied to a thermo-couple will cause a small emf. and therefore a small current to flow. Practical use of this is mainly in instruments.

A coil of wire rotated in the magnetic field of a magnet will produce an emf and can cause current to flow. This is the basis of a generator. Chemical action such as in a battery produces an emf which can cause current to flow.

VOLTAGE, CURRENT RESISTANCE AND POWER

In a circuit with a bulb, the number of electrons through the lamp every second is the rate of flow. The cause of electron

flow is the electrical pressure. The lamp produces an opposition to the rate of flow set up by the electrical pressure. Power is the rate of doing work or changing energy from one form to another. All these quantities are given names:

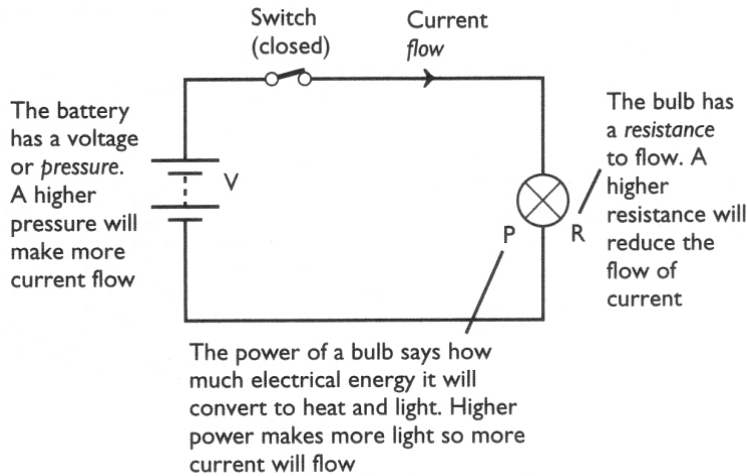

Name	Definition	Name	Symbol	Abbreviation
Electrical flow or current	The number of electrons past a fixed point in one second	Ampere	I	A
Electrical pressure	A pressure of 1 volt applied to a circuit will produce a current flow of 1 amp if the circuit resistance is 1 ohm.	Volt	V	V
Electrical resistance	This is the opposition to current flow in a material or circuit when a voltage is applied across it.	Ohm	R	Ω
Electrical power	When a voltage of 1 volt causes a current of 1 amp	Watt	P	W

to flow the power developed is 1 watt.

If the voltage applied to the circuit was increased but the lamp resistance stayed the same, then current would increase. If the voltage was maintained constant but the lamp was changed for one with a higher resistance the current would decrease. This relationship is put into a law called Ohm's Law.

Ohm's law states that in a closed circuit the current is proportional to the voltage and inversely proportional to the resistance. Using symbols this means:

$$\text{Voltage} = \text{Current} \times \text{Resistance} \quad (V = IR) \text{ or } (R = V/I) \text{ or } (I = V/R)$$

When one Volt causes one Ampere to flow the power used (P) is one Watt.

$$\text{Power} = \text{Voltage} \times \text{Current} \quad (P = VI) \text{ or } (I = P/V) \text{ or } (V = P/I)$$

Three terms are useful when discussing electrical circuits:

- Open circuit. This means the circuit is broken therefore no current can flow.
- Short circuit. This means that a fault has caused a wire to touch another conductor and the current uses this as an easier way to complete the circuit.

- High resistance. This means a part of the circuit has developed a high resistance (such as a dirty connection), which will reduce the amount of current which can flow.

CONDUCTORS, INSULATORS AND SEMI-CONDUCTORS

All metals are conductors. Silver, copper, aluminium are among the best and are frequently used. Liquids which will conduct an electric current are called electrolytes. Insulators are generally non-metallic and include rubber, porcelain, glass, plastics, cotton, silk, wax paper and some liquids. Some materials can act either as insulators or conductors depending on conditions. These are called semiconductors and are used to make transistors and diodes.

FACTORS AFFECTING RESISTANCE OF A CONDUCTOR

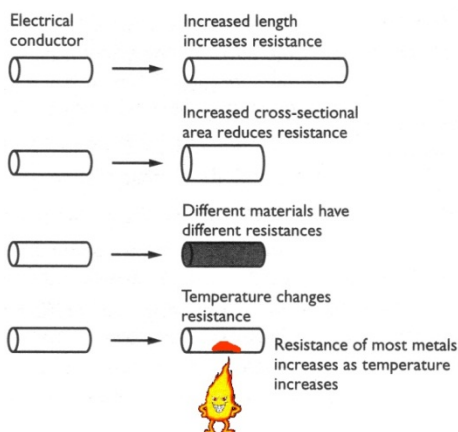

In an insulator a large voltage applied will produce a very small electron movement. In a conductor a small voltage applied will produce a large electron flow or current. The amount of resistance offered by the conductor is determined by a number of factors.

- Length, the greater the length of a conductor the greater is the resistance
- Cross sectional area, the larger the C.S.A. the smaller the resistance
- The material from which the conductor is made, the resistance offered by a conductor will vary according to the material from which it is made. This is known as the resistivity or specific resistance of the material
- Temperature, most metals increase in resistance as temperature increases

RESISTORS

Good conductors are used to carry the current with minimum voltage loss due to conductor resistance. Resistors are used to control the current flow in a circuit or to set voltage levels. They are made of materials that have a fairly high resistance. Resistors to carry low currents are often made of carbon. Resistor for high currents are usually wire wound.

CIRCUIT NETWORKS

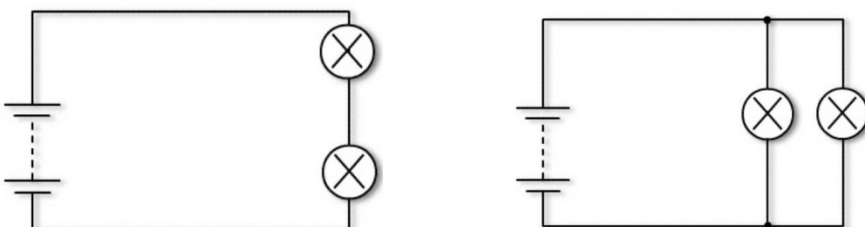

When resistors are connected so that there is only one path for the same current to flow through each resistor they are said to be connected in series. Rules for series circuits:

- Current is the same in all parts of the circuit
- Applied voltage equals the sum of the volt drops around the circuit
- Total resistance of the circuit (R_T), equals the sum of the individual resistance values ($R_1 + R_2$ etc.)

When resistors are connected such that they provide more than one path for the current to flow in and have the same voltage across each component they are said to be connected in parallel.

Rules for parallel circuits:

- Voltage across all components of a parallel circuit is the same
- Total current = sum of the current flowing in each branch
- Current splits up depending on each component resistance
- Total resistance of the circuit (R_T) $1/R_T = 1/R_1 + 1/R_2$
or $R_T = (R_1 \times R_2)/(R_1 + R_2)$

MAGNETISM AND ELECTROMAGNETISM

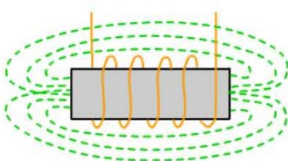

Magnetism can be created by a permanent magnet or by an electromagnet (one of the three effects of electricity remember). The space around a magnet in which the magnetic effect can be detected is called the magnetic field. The shape of magnetic fields in diagrams is represented by flux lines or lines of force.

Some rules about magnetism:

- Unlike poles attract. Like poles repel
- Lines of force in the same direction repel sideways opposite direction they attract
- Current flowing in a conductor will set up a magnetic field around the conductor. Strength of magnetic field is determined by how much current is flowing
- If a conductor is wound into a coil or solenoid, the resulting magnetism is the same as a permanent bar magnet

Electromagnets are used in motors, relays and fuel injectors to name just a few. Force on a current carrying conductor in a magnetic field is caused because of two magnetic fields interacting. This is the basic principle of how a motor works.

ELECTROMAGNETIC INDUCTION

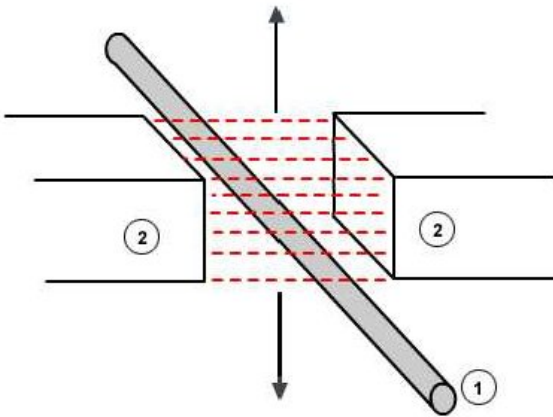

Basic laws:

- When a conductor cuts or is cut by magnetism a voltage is induced in the conductor
- The direction of the induced voltage depends upon the direction of the magnetic field and the direction in which the field moves relative to the conductor
- The size is proportional to the rate at which the conductor cuts or is cut by the magnetism

This effect of induction, meaning that voltage is made in the wire, is the basic principle of how generators such as the alternator on a car work. A generator is a machine that converts mechanical energy into electrical energy.

MUTUAL INDUCTION

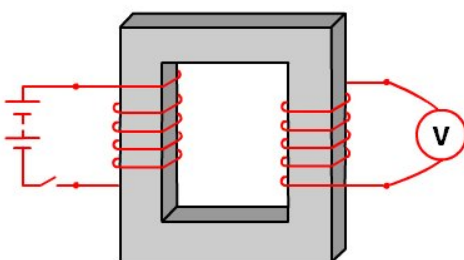

If two coils (known as the primary and secondary) are wound on to the same iron core then any change in magnetism of one coil will induce a voltage in to the other. This happens when a current is switched on and off to the primary coil. If the number of turns of wire on the secondary coil is more than the primary a higher voltage can be produced. If the number of turns of wire on the secondary coil is less than the primary a lower voltage is obtained. This is called transformer action and is the principle of the ignition coil. The value of this 'induced' voltage depends upon:

- Primary current
- Turns ratio between primary and secondary coils
- The speed at which the magnetism changes

CAPACITORS

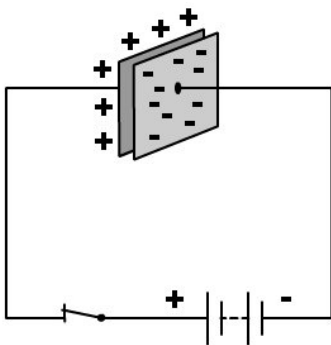

A capacitor is a device for storing an electric charge. In its simple form it consists of two plates separated by an insulating material. One plate can have excess electrons compared to the other. On vehicles its main uses are for reducing arcing across

contracts and for radio interference suppression circuits as well as in electronic control units.



Look back over the previous section and write out a list of the key bullet points here:

MATERIALS

INTRODUCTION

Different materials are used in different places on motor vehicles because of their properties. If I give a simple example it will make this clear. Cast iron is normally used for the very hot exhaust manifold but could plastic be used instead? Well probably not, and it is obvious why. However if we said, could we use aluminium instead? This time it is not obvious and more thought is required to decide the most suitable material.

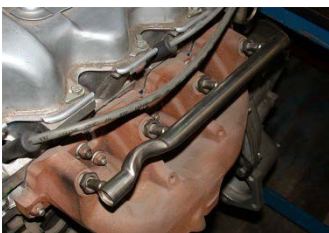

The following table lists several types of material together with important properties. As a rough guide these are given as a number from 1 (best) to 5 (worst) in a kind of league table. This makes the table easier to use for comparing one material to another.

Material	Ease of shaping	Strength	Resistance to heat	Electrical resistance	Corrosion resistance	Cost	Typical MV uses
Copper	2	3	2	1	3	4	Wires and electrical parts
Aluminium	2	3	2	1	3	4	Cylinder heads
Steel	3	2	1	1	4	3	Body panels and exhausts
Cast iron	3	2	1	1	4	3	Manifolds and engine blocks
Platinum	3	1	1	1	2	5	Spark plug tips
Soft plastic	1	5	5	5	1	1	Electrical insulators
Hard plastic	1	4	4	5	1	1	Interiors and some engine components
Glass	3	5	2	5	1	2	Screens and windows
Rubber	2	4	5	5	3	2	Tyres and

							hoses
Ceramic s	4	4	1	5	1	4	Spark plug insulators

Note that this table is just to help you compare properties; the league table positions are only rough estimates and will vary with different examples of the same material.

CORROSION

Corrosion is the eating away and eventual destruction of metals and alloys (a mixtures of metals) by chemical action. Most metals corrode eventually but the rusting of ordinary iron and steel is the most common form of corrosion. Rusting of iron or steel takes place in damp air, when the iron combines with oxygen and water to form a brown deposit known as rust. Higher temperatures make this reaction work more quickly. Salty road and air conditions make car bodies rust more quickly.

Some materials other than metals corrode or perish over a period of time, rubber based materials for example. Plastics have the great advantage that they appear to last for ever!

TERMS USED TO DESCRIBE MATERIALS:

Property	Explanation
Hardness	Can withstand indentation (marking).
Softness	Can be easily indented.
Toughness	The ability to resist fracture.
Brittleness	Breaks or shatters under shock loads (impact).
Ductility	Plastic (deforms and stays that way) under tension or

	stretching.
Malleability	Plastic under compression (squeezing).
Plasticity	The ability to retain a deformation after a load is removed.
Elasticity	The ability to return to its original shape when a deforming load is removed.
Strength	The ability to withstand a load without breaking.



Look back over the previous section and write out a list of the key bullet points here:

MECHANICAL MACHINES

INTRODUCTION

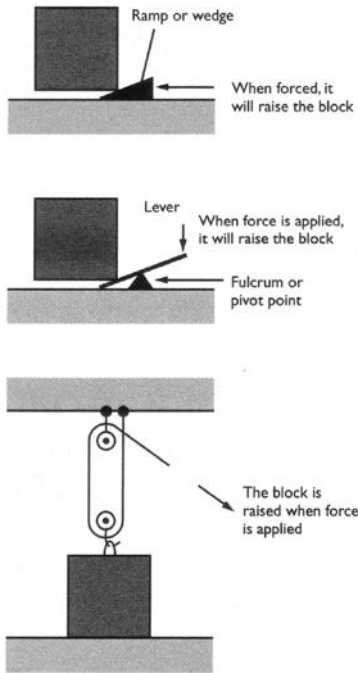

A simple mechanical machine is a device that allows a small force to overcome a larger force. There are only three basic machines:

- Ramp - such as a wedge
- Lever - such as a lever!
- Wheel and axle - such as pulleys and a belt

All other machines are combinations of these three. This is a good way of making any complicated machine easier to understand. The main features of a machine are:

- Mechanical advantage, which is the ratio of load to effort (think of a car jack)
- Velocity ratio, which is the velocity input compared to the velocity output (think of a car gear box)

- Efficiency, which is the work output divided by the work input as a percentage

In a perfect machine, with no friction, the efficiency would be 100%. All practical machines have efficiencies of less than 100% - otherwise perpetual motion would be possible!

GEARS



Gears are toothed wheels (like lots of levers) that transmits the turning movement of one shaft to another. Gear wheels may be used in pairs or in threes if both shafts need to turn in the same direction. The gear ratio, which is the ratio of the number of teeth on the two wheels determines:

- The torque ratio - the turning force on the output shaft compared with the turning force on the input shaft.
- The speed ratio - the speed of the output shaft compared to the speed of input shaft.

Gears with the ratio 2:1 (say 20 teeth input and 10 teeth output) will have an output twice the speed, and half the torque of the input.

A common type of gear for parallel shafts is the spur gear, with straight teeth parallel to the shaft axis. The helical gear (most common in car gear boxes) has teeth cut at an angle in a corkscrew shape. The double form of the helical gear is the most efficient for energy transfer.

HYDRAULICS

Hydraulics means using the properties of liquids, to transmit pressure and movement. The best known machines of this type are the hydraulic press and the hydraulic jack. The principle of pressurised liquid and increasing mechanical efficiency is also ideal for use on vehicle braking systems.

A basic hydraulic system consists of two liquid-connected pistons in cylinders, one of narrow bore, one of large bore. A force applied to the narrow piston applies a certain pressure to the liquid, which is transmitted to the larger piston.

Because the area of this piston is larger, the force exerted on it is larger. The original force has been increased, although the smaller piston has to move a greater distance to move the larger piston only a little. Mechanical advantage is gained in force, but lost in movement.

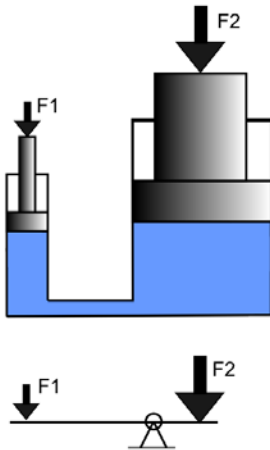

Look back over the previous section and write out a list of the key bullet points here:

MATHS

PERCENTAGES

Example 1: If the data book says 30% antifreeze and the cooling system holds 8 litres, how much antifreeze should you add?

Well, 30% means 30/100 which cancels to 3/10

$$3/10 \times 8 = 24/10 = 2.4 \text{ litres}$$

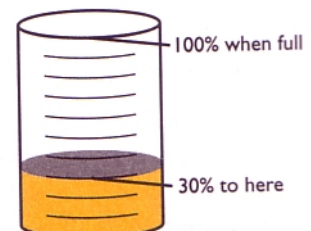

Example 2: Normal pay rate of £5 per hour, how much will you now get?

Well , 22% means 22/100

$22/100 \times £5 = £1.10$ Your new pay rate is £5 + £1.10p
£6.10 per hour

FRACTIONS

Example 1: Normal pay rate of £5 per hour, how much will you now get?

Well, time and a quarter means $1\frac{1}{4} \times$ your normal rate

$$1\frac{1}{4} \times £5 = 5/4 \times 5/1 = 25/4 = 6.25$$

Your overtime pay rate is £6.25 per hour

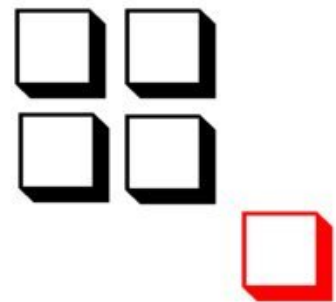

Example 2: If a heater blower circuit has a 2Ω and a 3Ω resistor connected in parallel by the speed control switch, what is the combined resistance?

Well, looking back to the electrical section you will see the formula is: $1/R_T = 1/R_1 + 1/R_2$

which means $1/R_T = 1/2 + 1/3$

to add fractions the bottom numbers must be the same

$$1/R_T = 3/6 + 2/6 \quad 1/R_T = 5/6 \quad R_T = 6/5 = 1.2\Omega$$

RATIOS

Example 1: If the maximum speed an alternator can run at is 15 000 rev/min and the top speed of the engine is 6000 rev/min, why is the pulley ratio 2.5:1.

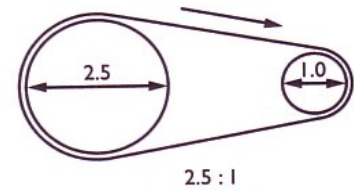

Well, $15\ 000 / 6\ 000 = \underline{2.5}$ (the ratio of the speeds) so the alternator can never be driven too fast.

AREAS

Example: If the bonnet is 1.2 m long and 1.1 m wide and the aerosol says it will cover 1.5 m² will it be enough?

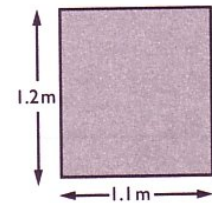

Well, the area is $1.2 \times 1.1 = \underline{1.32\ m^2}$

Yes you have got enough paint (for one coat)!

VOLUMES

Example: If the bore of a four cylinder engine is 8 cm and the stroke (distance from BDC to TDC) is 6.9 cm. What is the capacity of the engine?

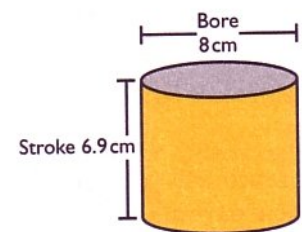

Well, the volume of a regular solid is the area x the height so for a cylinder the area is πr^2 so the volume must be $\pi r^2 h$ (r, the radius is half the bore diameter, h is the stroke)

$= 3.14 \times 4 \times 4 \times 6.9 = 346.66$ (now x 4 cylinders) = 1386.62cc

Probably called a 1400 cc or a 1.4 lt. engine

INDICES

Example: Looking back to the electrical section if I had described completely what the current flow of 1 Ampere means, I should have said: 6 000 000 000 000 000 000 000 electrons pass a point in one second!

$$6 \times 10^{23}$$

Well, it is much easier to write 6×10^{18} this simply means 6 with 18 zeros after it.

This quantity of electrons is known as a Coulomb. It is about enough electricity to work a heavy duty starter motor for about 0.001 seconds!

This could be written as 10^{-3} s this means moving the 'point' 3 places to the left (dividing by 1000).



Look back over the previous section and write out a list of the key bullet points here:

DRAWINGS

INTRODUCTION

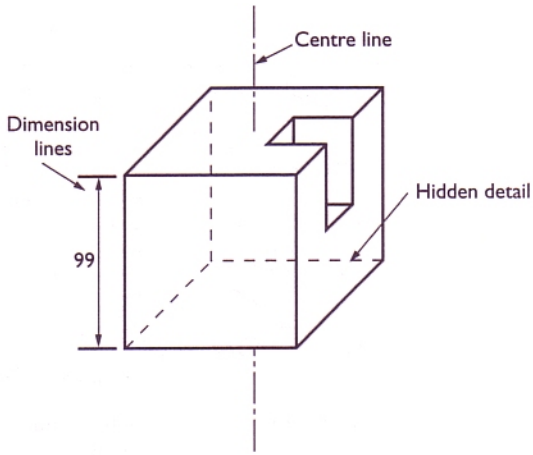

Drawings are an ideal way to pass on important information. Many manufacturers provide information in the form of drawings. It is essential that you can interpret the details you need and are not put off by the amount

of information presented.

To help you do this, some simple standards are used relating to the type of lines:

Continuous thick line outlines		Visible
Continuous thin line Projection, dimension and hatching lines		
Short thin dashes		Hidden details
Long thin chain lines		Centre
Long chain planes		Cutting

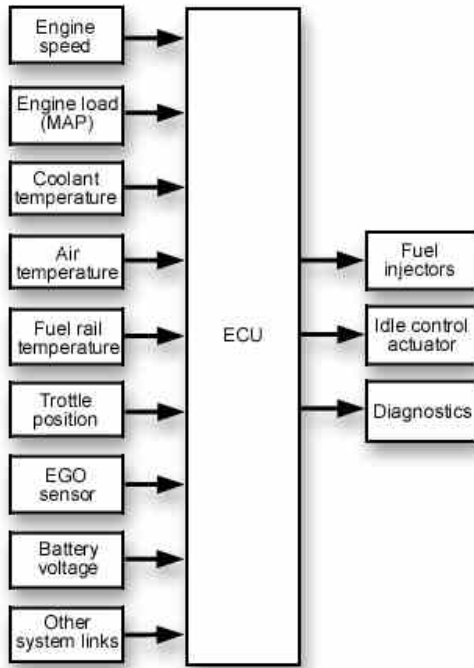

TERMINOLOGY USED ON DRAWINGS

Sections	When the inside details of an object are important it is often convenient to show this by sectioning or cutting the object in a suitable place. A sectioned view of a brake cylinder is a good example.
Dimensions	Lines with arrow heads in some cases to simply show the size of the object. This is used more for drawings used to make an item than to pass on information for repair.
Tolerances & Limits	Dimensions can never be dead on although very close in some cases. A good example of a tolerance or limit on a motor vehicle drawing could be the bore of a cylinder given as 70 ± 0.05 mm.
Fits	Two types of 'fit' can be used. Clearance fit, where say a pin is slightly smaller, and therefore slides into a hole. Interference fit is where the pin would be very slightly too large and would need pressing into the hole.

Projection	A term used to describe the way an object is drawn. You can imagine it as if projected on to a screen from different angles.
Line diagram	A simplified diagram showing only the most basic of information.
Block diagram	Complicated systems can be simplified by representing say the fuel system as one block and the engine as another and so on.
Exploded diagram	This is often used in workshop manuals. It shows a collection of components spread apart to show their details and suggest their original positions.

SOURCES OF DRAWINGS AND OTHER INFORMATION

Technical bulletins	Sheets of information sent from manufacturers to the dealers outlining the latest repair information.
Parts books	Often the pictures or drawings in parts books are useful for repair procedures as they often show all the component parts of an object.
Textbooks	This one of course but a number of other good books are available.
Workshop manuals	This is the traditional source of detailed information on specific vehicles and systems.
Microfiche	A microfilm is often used to store pictures and information as a large amount can be stored in a small space. It is like a very small photograph negative read on a viewer.
Video	Video tapes are available on many topics. They are mostly ideal as training aids.
Computer	The computer is increasingly becoming essential in many ways. A large amount of data can be kept on disk and retrieved with a few key strokes.
CD and DVD compact disk	One DVD can hold a massive amount of information (many workshop manuals full), and this information can be accessed quickly and easily by a computer.

On line
databases

Many sources of information are now available 'on line'. This means that with a computer and modem you can access remote databases.

TYPES OF DRAWING

Drawings can be produced in a number of ways, the most ideal for engineering type drawings are as follows:

- Orthographic projection, where three elevations are shown, usually a front, plan and end view.
- Pictorial projections, such as isometric and oblique, show a representation of what the item looks like. The isometric view is used often in workshop manuals to show the arrangement of a complicated system.

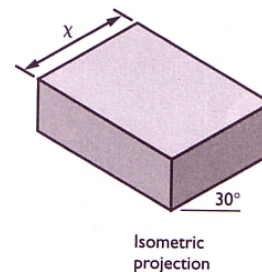
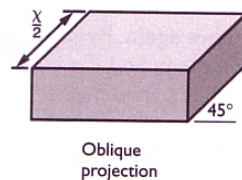
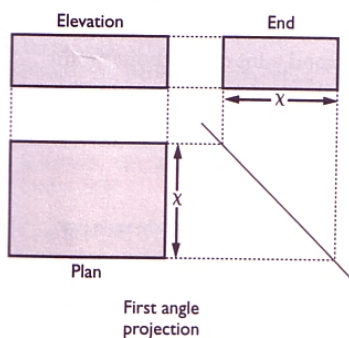

Look back over the previous section and write out a list of the key bullet points here:

WORKSHOP SAFETY, HOUSEKEEPING AND WORKING RELATIONSHIPS

CONTRIBUTE TO WORKPLACE GOOD HOUSEKEEPING

LEGAL REQUIREMENTS

Introduction Everyone wants to see a clean and tidy workshop, employers, technicians, customers, health and safety inspectors, etc. Good housekeeping is important not only for general appearance but also for health and safety reasons. Good housekeeping makes for:

- A more pleasant place to work
- A more efficient and effective place to work
- A safer place to work
- An organisation in which customers can trust.

In this unit you will learn the necessary skills to contribute to good housekeeping in your workplace and also for your qualification. I have divided the learning programme into the following sections:

1. Legal requirements and procedures and your workplace requirements/procedures
2. Maintaining equipment
3. General work area housekeeping

Some cleaning and maintenance is not specialised and you may well be given responsibility for this from the start of your employment. Even though it is non-specialised it still carries

with it some responsibility. Look to see if the tool or piece of equipment has any instructions given by the manufacturer. If it does - then follow it. Manufacturers' requirements are there for a reason sometimes for your own safety.



As well as legal requirements that a company has to follow each organisation will have its own housekeeping policy/procedure. This may include a rota for various tasks, general cleaning for example. Make sure you are aware how your workshop operates. If there is a list or rota then make sure you read it, especially if you know your name is on it.

Even in the most efficient and professional workshops delays are bound to occur. Unexpected tasks, equipment failure, sickness, injury, etc. can all contribute to delays in work being finished on time. If this happens to you then it is important that you inform the necessary person(s) of this delay. A business can quite easily lose custom from jobs not being finished on time, especially if no one has bothered to call the customer.



Your organisation will no doubt have its own procedure of how to report delays. In most cases it is likely to be verbal. As an example, let's look at this telephone conversation between Gary the service manager and Karen the receptionist. All equipment whether large or small will need to be inspected regularly to see that it is in proper working order. Your company may have a list of dates for the scheduled servicing of large pieces of equipment. This is a good idea as long as the schedule is followed. If you notice that the servicing for a piece of equipment has not been made, then report it to the relevant person.



Most, if not all, of the information that you will be required to know relating to good housekeeping can be found in the following regulations. These are:

- HASAWA - Health and Safety At Work Act (1974)
- COSHH - Control Of Substances Hazardous To Health.

Health And Safety At Work Act HASAWA Health and Safety At Work Act (1974). The act is designed to make all of us aware of workplace dangers. It places responsibility on employers and employees to keep a safe working environment. It also gives strict instructions on employers being fully trained in cleaning or maintaining certain pieces of equipment

COSHH - Control Of Substances Hazardous To Health. Some of the materials required for cleaning in the workshop are a hazard to health if they are not used correctly. This will enforce the correct handling and storage of such materials

 Look back over the previous section and write out a list of the key bullet points here:

GENERAL HOUSEKEEPING

It is not surprising that servicing and fixing motor vehicles is in some cases a dirty job. That's why it is important to clean up as soon as you can after any dirty job. Dirt and clutter mount up very quickly. It is also a legal requirement that your employer provides a clean and safe place to work. So make sure you get in the habit of keeping your work area and tools clean and tidy or you may just have your boss breathing down your neck.



The workshop floor should be clean and uncluttered as this will help to prevent accidents as well as maintaining the general appearance. All breakages and spillages should be cleaned immediately. This is especially important if it is a harmful substance and to avoid a work mate or yourself slipping. Sometimes it may be necessary to place notices or cones as warnings, e.g. 'cleaning in progress'

Cleaning materials In motor vehicle workshops many different cleaning operations are carried out. This means a number of different materials are required. It is not possible to mention every brand name here so I have split the materials into three different types. It is important to note that the manufacturers' instructions printed on the container must be followed at all times.



Detergents Detergents are mixed with water for washing vehicles, etc. They are also used in steam cleaners for engine

washing etc. Some industrial detergents are very strong and should not be allowed in contact with your skin and obviously your eyes. Wear PPE, we'll talk more about this later. Solvents are used to wash away and dissolve grease and oil. The best example is the liquid in the degreaser or parts washer, which all workshops will have. NEVER use solvents such as thinners or petrol because they are highly inflammable. Suitable PPE should be used, for example gloves, etc.

Absorbent granules mop up oil and other types of spills. After a short time they soak up the spillage and can then be swept up. Most granules are a chalk or clay type material which has been dried out.



Some extra notes about solvents:

- They may attack your skin
- Many are flammable
- The vapour given off can be dangerous.

Take extra care! Read the label - this will tell you not only how to use it safely but also what to do if the cleaning material does splash onto your skin and eyes.

All materials should have a description of how to use them and any dangers should be spelled out on the packaging. This is a

legal health and safety requirement and is covered in the regulation, Control Of Substances Hazardous To Health (COSHH). Remember: You should not use any cleaning materials unless trained.

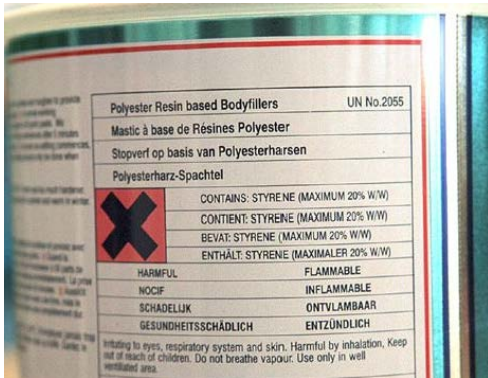

Dangerous waste materials are a potential hazard. These may include used engine oil, scrap exhausts, old batteries, etc. These waste materials must be disposed of in different ways and local councils usually decide this. The requirements vary in different places. Some materials must be kept separate and are collected by specialist agencies, or taken to a local refuse point.

Many resources are available in the workshop for your use. Remember to use these economically and sometimes sparingly. If the instructions say to only use a certain amount of a substance then only use that amount. To use more can sometimes be a health and safety hazard.

A good example of this would be in the use of engine cleaning fluid. Large amounts of this fluid running down drains is detrimental to the environment.

Appropriate Personal Protection Equipment (PPE) must be used when cleaning and maintaining equipment and also when using cleaning materials generally. Many of the substances used for cleaning are hazardous to the skin and eyes. Special care must be taken with solvents as they are flammable and some give off dangerous vapour. Some PPE and their uses are shown on the following screen. Remember: Overalls must be worn at all times to protect clothing.



Safety goggles - Use safety goggles when there is any risk of eye contamination, e.g. splashes from a cleaning material.

Rubber or plastic gloves - Make sure that these are free from holes. Gloves must always be worn when using degreasing equipment.

Rubber or plastic apron - Replace if it has holes. Aprons should be worn when using strong acids and solvents.

Safety boots and shoes - These should be worn when working with any heavy equipment. Other items of PPE that are used in the workshop include the following:

- Safety helmet
- Welding goggles or mask
- Ear defenders
- Face mask
- Leather gloves
- High visibility clothing.

📖 Look back over the previous section and write out a list of the key bullet points here:

EQUIPMENT MAINTENANCE

The cleaning and maintenance of equipment plays a big part in good housekeeping. This includes large equipment such as ramps, hoists, etc. to small hand tools. Always remember that no one should clean, maintain or use large equipment unless they have had sufficient training or are working under the supervision of an experienced and qualified person.



- Hand tools are expensive so do look after them and in the long term they will look after you.
- Technicians need to learn and be aware of the following points regarding equipment:
- Select and use equipment for basic hand tool maintenance activities
- Storing hand tools safely and accessibly
- How to report faulty or damaged work tools and equipment
- Safety when cleaning and maintaining work tools and equipment.

It is important to store hand tools safely. Any hand tool left lying around can be a potential hazard to the unsuspecting person or could cause damage to a customer's vehicle. Always make sure that hand tools are stored correctly in either a tool box or in the designated place. If you think that you are likely to need a particular tool in due cause and don't want to put it back then be aware of where you place it. Obviously you will want it handy but at the same time you need to think of safety.

Safety also applies to the tool you are using. Don't put it down in a place where it can be damaged. Wherever you store or place a hand tool think of the following points:

- Safety of yourself and others.
- Protection of the customer's vehicle.
- Protection of other tools and workshop equipment.
- Protection of the tool itself.

From time to time tools and equipment will develop faults or get damaged, however careful you are with them. If you find any damage to equipment it is your duty as a technician to report it or see if it has already been reported.



Don't leave it to someone else or assume that it must have been spotted by one of your colleagues. It is quite likely that it hasn't.

Does your workshop have a procedure for reporting faulty equipment? Does it need to be written on a report form for instance? Who is the appropriate person to report this fault to? Your supervisor or perhaps another member of staff. Whoever and however it needs to be done quickly. Delay could possibly make the fault worse but more importantly if it needs to be used, work will be held up. Would this fault be a potential safety issue? Obviously a very important point to consider. Report it immediately so the problem can be fixed.

In the previous section I mentioned the importance of working safely when cleaning or maintaining equipment. It is important to remember that you must never clean or maintain equipment without adequate training or supervision from a qualified and

competent person. Even if you are asked politely say 'no' and explain why. It would be quite likely that the person who asked you to do the task is unaware that you do not have the relevant experience.

 Look back over the previous section and write out a list of the key bullet points here:

ENSURE YOUR OWN ACTIONS REDUCE RISKS TO HEALTH AND SAFETY

INTRODUCTION TO HEALTH AND SAFETY

Introduction It is tempting to think that health and safety is a boring subject. Well it's not half as boring as spending months in hospital, the rest of your life in a wheel chair or doing time in prison! These three things are all possible if health and safety rules are not followed. Health and safety plays an important part of any automotive work. You will have to learn quite a few new things in this learning programme but you will also come to realise that most of it is common sense.

Whose responsibility? Health and safety is the responsibility of everyone in the workplace. The following screen gives an example of how not observing health and safety rules can affect many people besides yourself.

The accident Working on a customer's car you jack up the front, "forget" to use axle stands. Whilst sitting on the floor with your legs under the car, a leaking seal on the jack finally gives in and the car drops onto your legs. Later in hospital you find out that you have a broken ankle on one leg and the knee cap on the other is shattered. Let me now ask five simple questions and then suggest answers.



1. How could this accident affect you? Apart from the obvious severe pain you are likely to lose money from being off work. In extreme cases you may never be able to work again.
2. How could this accident affect your employer? Your employer could be in serious trouble if he or she contributed in any way to the accident by not following regulations. At the very least the employer will lose money while you are off and will be put to a great deal of trouble sorting out the problems.
3. How could this accident affect your work mates? If the health and safety inspection, which would follow such an accident, found other problems, the workshop may be closed down. Your mates might lose their jobs. At the very least they would have to work harder to make up for you being off work.
4. How could this accident affect your family? Depending how serious your injuries are, your family may have to look after you for a long time or even for life. The least that will happen is that they will be very upset and put to a great deal of trouble visiting or looking after you.

5. Whose fault was the accident? Not mine! Somebody else's!
Come on it's not my fault. How was I to know the jack was
leaking ...

Hold on! In the end it can only ever come back to one person.
You! The blame could be spread out a bit; the jack should not
have been used if it was leaking. Maybe your employer should
have noticed this. You should have been trained to use axle
stands. Maybe your supervisor should have stopped you. Like I
said though, there is only one person who could have been
certain to prevent you getting hurt. You!

Terminology The following screens give the different terms and
definitions that you will need to know regarding Health and
Safety. You will find these names, terms and their abbreviations
used often so do become familiar with them.

- **HASAWA and COSHH** HASAWA - Health and Safety At
Work Act. The act is designed to make all of us aware of
workplace dangers.
- **COSHH** - Control Of Substances Hazardous To Health.

Health and safety inspectorate A government agency that
makes sure the HASAWA is carried out.

Health and safety audit An inspection carried out in a
workshop. For example to check for anything which may not
comply with regulations.

Risk assessment As part of an inspection you may examine, say, a wheel free ramp. The risks in using this equipment should be assessed and then reduced as much as is reasonably possible.



📖 Look back over the previous section and write out a list of the key bullet points here:

HEALTH AND SAFETY REGULATIONS

NOTE: You must check the health and safety guidance appropriate to the country or region you are working in. Here are three useful links:

United Kingdom and Northern Ireland: <http://www.hse.gov.uk>

Australia: <http://www.commerce.wa.gov.au/WorkSafe/>

Ireland: <http://www.hsa.ie/eng/>

Health and Safety at Work Act (1974) The Health and Safety at Work Act (1974) places a strict duty on employers to ensure, so far as is reasonably practicable, safe working conditions and the absence of risks to health in connection with the use, handling, storage and transport of articles and substances.

Safety policy The Act places a statutory duty on employers to have a declared safety policy for a business in which more than five people are employed. The Act does not specify what you should do; it merely provides the framework in which you should operate, together with establishing the Health and Safety Executive and the Health and Safety Commission. The Act regulates all working methods. The importance of this Act cannot be overemphasised: no working methods may be employed that can be seen to be a health or safety hazard to employees.



Safety committee First, a company safety policy must be established and a safety committee formed. The committee should consist of members with specialised knowledge of the risks of a particular area, such as the workshop or offices. The

chairman of the committee should be a senior member of the company.

Two areas The act can be split into two areas.

1. Employers have a duty to safeguard the health, safety and welfare of their employees.
2. Employees have a duty to safeguard themselves and their work mates.

Each of these areas are briefly summarised on the following screens, note in each case how you can apply the 'common sense' idea.

Employer's duty The employer must provide the following:

- Safe place of work with safe access and exits
- Safe working environment and appropriate welfare arrangements
- Safe systems of work
- Safe plant, equipment and tools
- Safe methods of storing, handling and moving goods
- A procedure for reporting accidents and an accident book
- A safety policy
- Information, instruction, training and supervision where appropriate.

Employee's duty As an employee you must:

- Co-operate with your employer to comply with the HASAWA
- Take care of your own health and safety as well as that of your workmates
- Not interfere with or misuse any health and safety items.

Health and Safety Inspectorate The health and safety inspectorate is a government agency whose job is to make sure

that companies comply with the health and safety laws. As part of their job they carry out the following:

- Inspect work places to ensure that the HASAWA and other safety laws are being observed
- Investigate the causes of serious accidents
- To prosecute anyone found breaking the laws (employer or employee).

Inspectorate The inspectorate has many powers including the right to enter your workshop and inspect it to make sure the law is being followed. If any problems are found the inspectorate can carry out one or all of the points on the next few screens.

Issue an improvement notice This gives the owner of the premises a set time to improve something. For example, put up warning notices.

Issue a prohibition notice This says that the work being carried out in a particular place must stop until the problem is put right. For example, have the ramp repaired and tested before it is used again.



Prosecute the person breaking the law Either the employer or the employee. For example, after a serious accident the

inspectorate can take the case to court where very large fines, and/or imprisonment, can be the result. Anybody, including employees, can ask the inspectorate to look into cases involving the health and safety laws.

Other safety acts, rules and regulations The HASAWA is the most important act but many other rules or regulations affect the workplace. This shows how important the well-being of workers is considered to be. You do not have to learn this section off by heart but you must be aware that a variety of legislation exists. You may see notices displayed in your workshop that will include some or all of the following list. Others may also be relevant. You should read these notices listed on the following screen:

- The Health & Safety at Work Act (HASAWA)
- Workforce Directive
- Office, Shops and Railway Premises Act
- Control of Substances Hazardous to Health Regulations (COSHH)
- Reporting of Injuries, Diseases and Dangerous Occurrences
- Regulations governing working equipment (including abrasive wheels)
- Regulations governing electricity
- Regulations governing disposal of waste products
- Regulations governing manual handling
- Regulations governing use of vehicles
- Regulations governing movement of people
- Regulations governing noise
- Regulations governing computers and display screen equipment.

Heavy reading The HASAWA is the most important act as it places duties on the employer and employee. However, if you need to refer in detail to any others in the previous list the full

regulations can be obtained from your local library. They do make rather heavy reading though, so, in most cases if you are in any doubt ask your supervisor.

 Look back over the previous section and write out a list of the key bullet points here:

GOOD WORKING PRACTICES

Personal protection equipment Personal protection equipment, such as safety clothing is very important to protect yourself. Some people think it clever or tough not to use protection. They are very sad and will (more than likely die or be injured long before you! Some things are obvious such as when holding a hot or sharp exhaust you would likely be burnt or cut! Other things such as breathing in brake dust or working in a noisy area, do not produce immediately noticeable effects but could affect you later in life. Please, do not allow peer pressure to affect your safety.







Suitable equipment Fortunately the risks to workers are now quite well understood and we can protect ourselves before it is too late. In the following table I have listed a number of items classed as PPE (Personal Protective Equipment) together with

suggested uses. You will see that the use of most items is plain common sense.

Where a hazard has been identified your employer should by law supply suitable equipment. However the ideal situation is that jobs to be carried out would not require PPE. Unfortunately there is still a long way to go on this front.

Equipment	Notes	Examples
 Ear Defenders		
 Face mask		
 High Visibility Clothing		
 Leather Apron		
 Leather Gloves		
 Overalls		

Please study the table detailing PPE and add notes to the picture

Equipment	Notes	Examples
 Rubber or Plastic Apron		
 Rubber or Plastic Gloves		
 Safety Shoes or Boots		
 Safety Goggles		
 Safety Helmet		
 Welding Goggles or Welding Mask		

Add notes to the table in the space provided.

Good working practice - Identifying and reducing hazards:

Working in a motor vehicle workshop is a dangerous occupation - if you do not take care. The most important thing is to be aware of the hazards and then it is easy to avoid the danger. The hazards in a workshop are from two particular sources:

- You
- Your surroundings.



Workshop Hazards Over the next few screens you will see various videos showing a technician whose actions could easily cause hazards. Of course the common fault in each of the videos is that he is not wearing overalls or using any personal safety equipment!

Carelessness Carelessness of any kind but particularly whilst moving vehicles.

- Drinking/drugs Drinking or taking drugs - these badly affect your ability to react to dangerous situations.
- Your health Tiredness or sickness - these will affect your abilities to think and work safely.
- Fooling about Messing about - most accidents are caused by people fooling about.

Safety equipment It is important to always use safety equipment such as trolleys, cranes, etc. and to be competent in using them. As with the use of any equipment and all aspects of work if you are in any doubt it is important to ask. If it involves a person's health or safety then it is vital. Inexperience and lack of supervision are potential hazards

Your surroundings The surroundings, in which you work, may have:

- Bad ventilation
- Poor lighting
- Noise
- Dangerous substances stored incorrectly
- Broken or worn tools and equipment
- Faulty machinery
- Slippery floors
- Untidy benches and floors
- Unguarded machinery
- Unguarded pits.

Hazards in the workshop The following tables list some of the hazards you will come across in a vehicle workshop. Also listed are the problems these can cause, together with ways we can reduce the risks. This is called risk assessment.

Please study the tables and add notes above about the five hazards that you think are most important.

Moving loads Never try to lift anything beyond your capability - get a mate to help. Over 40 kg and you really should get help.

- Whenever possible use an engine hoist, a transmission jack or a trolley.
- Lift correctly, using the legs and keep your back straight.
- When moving heavy loads on a trolley, get help and position yourself so you will not be run over if you lose control.
- The ideal option in all cases is simply to avoid manual handling where possible.



Vehicle Safety Vehicle safety and the associated regulations can be very complicated. However for our purposes we can consider the issue across two main areas:

1. Construction of the vehicle
2. Driving and operating the vehicle.

Construction of the vehicle Before a vehicle can be constructed a prototype has to be submitted for type approval. When awarded this means the vehicle has passed very stringent tests and that it meets all current safety requirements.

Different countries have different systems, which mean some modifications to a car may be necessary if it is imported or exported. The European Union (EU) has published many 'directives', which each member country must incorporate into its own legislation. This has helped to standardise many aspects. In the UK the 'Road Vehicles (Construction & Use) Regulations 1986', is the act which ensures certain standards are met. If you become involved in modifying a vehicle e.g. for import, you may need to refer to the details of this act.

Environmental Laws Many other laws exist relating the motor vehicle and the environment. These are about emissions and pollution. Environmental laws change quite often and it will be important to keep up to date.

The MOT The Department Of Transport states that all vehicles over three years old must undergo a safety check which ensures the vehicle continues to meet the current legislation. First set up by the Ministry Of Transport, it continues to be known as the MOT test. This test now includes checks relating to environmental laws.



📖 Look back over the previous section and write out a list of the key bullet points here:

LOOK AFTER YOURSELF, YOUR WORKSHOP AND YOUR WORKMATES

Safety Procedures This main section is about learning how to; “Contribute to the limitation of damage to persons or property in the event of an accident or emergency”. When you know the set procedures to be followed, it is easier to look after yourself, your workshop and your work mates. The requirements are summarised on the following screen.

- First aid First aid equipment must be available.
- Employers should display simple first aid instructions.
- Fully trained first aiders must be employed.

In your own workplace you should know about the above three points.



Serious accident If you are confronted with a serious accident the following points of action should be adhered to:

- Assess the situation
- Remove the danger
- Get help
- Stay with the casualty
- Report the accident
- Learn first aid.

Assess the situation Stay calm and think for a few seconds what is important.

Remove the danger If the person was working with a machine, turn it off. If someone is electrocuted, switch off the power before you hurt yourself. Even if you are unable to help with the injury you can stop it getting worse.

Get help If you are not trained in first aid, get someone who is and/or phone for an ambulance.

Stay with the casualty If you can do nothing else, the casualty can be helped if you stay with him. Tell the casualty that help is on its way and be ready to assist. You may need to guide the ambulance.



Report the accident All accidents must be reported, your company should have an accident book by law. This is a record so that steps can be taken to prevent the accident happening again. Also if the injured person claims compensation, underhanded companies could deny the accident happened. Learn first aid If you are in a very small company why not get trained now, before the accident?

Reporting requirements As stated earlier, all accidents must be reported and your company should have an accident book by law. Accidents do not have to involve injury. If you report that a leaking jack seal caused a car to fall, even if no harm was done, you could prevent another accident which probably would be serious. The book allows a record to be kept so that steps can be taken to prevent the accident happening again. All accidents no matter how small should be reported. Even a scratch can become infected and therefore more serious but you should use your common sense. If an injured person claims compensation at some future time, the accident book provides a record of what happened. The book should be kept by a responsible person.

Fire Accidents involving fire are very serious. As well as you or a workmate calling the fire brigade (do not assume it has been done), three simple rules will help you know what to do:

- Get safe yourself and shout FIRE!
- Help others to get safe.
- Only fight the fire if it does not put you or others at risk.



Fuel, heat and oxygen 1 "It's easy to rebuild a car or a workshop - it's not easy to rebuild you"

Of course far better than the above situation is to not let a fire start in the first place! Three things are needed for a fire to start and keep burning

- Fuel
- Heat
- Oxygen.

Fuel, heat and oxygen 2

- Fuel - This can range from the obvious such as petrol to piles of rubbish or a car interior.
- Heat - A match or lighter, a spark from a cigarette or heat from a welding torch. Also electric sparks or a spark caused by dropping a steel object.
- Oxygen - The air contains about 20% oxygen.

The Fire Triangle Fuel, heat and oxygen together are often called the fire triangle. Unless all three are present a fire will not start or burn. There are two lessons to be learnt here. First is how to prevent the fire (best option), and second how to put

out a fire. To prevent the fire you must never allow all three things to come together. Any two do not cause a problem, a welding torch held in the air, or petrol spilt on a cold floor for example. The welding torch next to the spilt petrol on the other hand would cause a fire!

 Draw the fire triangle here

What to do in the event of a fire If a fire does happen your workplace should have a set procedure so for example you will know:

- How the alarm is raised?
- What the alarm sounds like?
- What to do when you hear the alarm?
- Your escape route from the building?
- Where to go to assemble?
- Who is responsible for calling the fire brigade?

Putting out the fire If it is safe to do so you should try and put out a small fire. Extinguishers and a fire blanket should be provided. Remember the object is to remove one side of the "triangle", and the fire will go out. Note however that this is not quite as obvious as it first seems. If you put enough water on a fire it will cool down and go out. However spraying water on an

electrical circuit could kill you! Spraying water on a petrol fire could spread it about and make the problem far worse.

Fire extinguishers This means that a number of different fire extinguishers are needed. These are colour coded to allow easy recognition. They are:

- Red - containing water
- Black - carbon dioxide
- Green - vaporising liquid (Halon BCF)
- Blue - dry powder
- Cream - foam
- Red blanket - fire proof blanket.

The table shows further important details.

All extinguishers have instructions written on them, read them now before it is too late.

Keep it clean There are three main reasons for keeping your workshop and equipment clean and tidy:

- It makes it a safer place to work
- It makes it a better place to work
- It gives a better image to your customers.



No one wants to see a dirty and untidy workshop, workers or customers. Visitors to the workshop and first time customers are much more likely to return. Also, you will be able to work more efficiently and effectively.

Keep customers happy For Example which of these two customer responses would you prefer.

'That place was filthy. I won't be going back there again.'

Or this one.

'I liked that garage. It was clean and tidy and seemed friendly and professional.'

A safe and clean place of work Servicing and fixing motor vehicles is in some cases a dirty job. But if you clean up after any dirty job then you will find your workshop a much more pleasant place to work. The HASAWA act makes the employer provide a safe and clean place of work. Further requirements are contained in the factories act.

A clean workshop The workshop and floor should be uncluttered and clean to prevent accidents and fires as well as

maintaining the general appearance. For example breakages and spillages should be cleaned immediately. It may be necessary to place notices or cones as warnings e.g. 'Cleaning in Progress'. Your workspace reflects your ability as a technician. A tidy workspace equals a tidy mind equals a tidy job equals a tidy wage when you are qualified.

Tools and equipment Hand tools should be kept clean as you are working. You will pay a lot of money for your tools, look after them and they will look after you in the long term. Large equipment should only be cleaned by a trained person or a person under supervision. Obvious precautions are to ensure equipment cannot be operated while you are cleaning it and only use appropriate cleaning methods. For example would you use a bucket of water or a brush to clean down an electric pillar drill? I hope you answered 'the brush'!

Cleaning materials In motor vehicle workshops many different cleaning operations are carried out. This means a number of different materials are required. It is not possible to mention every brand name here so I have split the materials into three different types. It is important to note that the manufacturer's instructions printed on the container must be followed at all times.

Detergents Detergents are mixed with water for washing vehicles, etc. They are also used in steam cleaners for engine washing etc. Some industrial detergents are very strong and should not be allowed in contact with your skin.

Solvents Solvents are used to wash away and dissolve grease and oil. The best example is the liquid in the degreaser or parts washer, which all workshops will have. NEVER use solvents such as thinners or petrol because they are highly inflammable. Suitable PPE should be used, for example gloves, etc.

Absorbent granules Absorbent granules mop up oil and other types of spills. After a short time they soak up the spillage and can then be swept up. Most granules are a chalk or clay type material which has been dried out.

Some extra notes about solvents:

- They may attack your skin.
- Many are flammable.
- The vapour given off can be dangerous.
- Serious problems if splashed in to eyes.
- Take extra care.

Read the label - this will tell you not only how to use it safely but also what to do if the cleaning material does splash onto your skin and eyes.

How to use materials As part of the COSHH (Control Of Substances Hazardous To Health) regulations, all materials should have a description of how to use them and the dangers should also be spelled out on the packaging. You should not use any cleaning materials unless trained.

Storage of cleaning materials Keep cleaning materials in a separate store, as many of these materials are highly concentrated. When finished with a cleaning material always put it back in the store.

Disposal of dangerous waste material Dangerous waste materials are a potential hazard. These may include used engine oil, scrap exhausts, old batteries, etc.

These waste materials must be disposed of in different ways and local councils usually decide this. These requirements vary in different places. Some materials must be kept separate and are collected by specialist agencies, or taken to a local refuse point.

 Look back over the previous section and write out a list of the key bullet points here:

MAINTAIN POSITIVE WORKING RELATIONSHIPS

WORKING RELATIONSHIPS

Introduction "He always gets the best jobs". "Why should I do that? It's not my responsibility". "I'm fed up with having to do her jobs. She's a girl, what do you expect".

Imagine working in an environment like this or sadly perhaps you already do. Of course from time to time we all have disagreements about certain things but surely the best way is to talk things through and sort out any problems in a friendly and professional manner. By studying this unit you will learn the necessary skills to maintain positive working relationships and gain the knowledge required for your qualification.

It's easy I'm sure that you will find this programme quite easy to learn, as it is mostly common sense. Hopefully it will also be quite fun. I have divided the learning programme into two sections:

1. Responsibilities , yours and your colleagues
2. Communication skills and working relationships

Your responsibilities To be a successful technician it is essential that you fully understand your responsibilities in the organisation. That's not only the jobs that you are required to do but also the jobs that you are not required to do and duties, that by law, you are not allowed to do.

Job description When you start work at an organisation you may be given a job description. At the very least it should be made clear to you verbally if it is not written down. Either way if you are unsure of your work duties do ask.

Knowing your duties In the following scenario a technician is asked something that he is not allowed to do because it is against health and safety regulations.



Steve should politely decline this request. It is against health and safety law to clean, maintain or use any equipment without adequate training. Later we will look at this scenario again for the wrong and right way to approach this. To simply refuse in a gruff manner would almost certainly cause offence. That's not the way to maintain a good working relationship.

Your work mates' responsibilities In the previous scenario Steve's work mate may not have realised that Steve had not been trained to do this job. To avoid confusion and breaking any laws and regulations it is important to know and understand your work colleagues' responsibilities. Also it will avoid any bad feeling from asking a mate to do something that just isn't part of his workload, especially if he is very busy.

Giving advice and support Knowing your job role and the limits of your responsibility for giving advice and support is essential. Don't feel pressured to give advice on something you are not qualified. Also it can be tempting to impress others with your knowledge but if you are unsure of something do make it clear that you are unsure. When the safety of someone is at stake never give advice unless it is your responsibility and then only if you are absolutely certain of your facts.

Lines of communication How do you communicate in your workshop? Are there any specific lines of communication within your organisation? If it is a large workshop there is almost certain to be. For instance if you notice that you may be running low on a product who should you inform. If someone has an accident, who is responsible for entering it into the accident book.

Job titles For the smooth running of an organisation it is necessary to follow these lines of communication. Start to get familiar with peoples titles and jobs and this often will tell you the appropriate person to speak with.

 Look back over the previous section and write out a list of the key bullet points here:

COMMUNICATION

Introduction The way we communicate with other people is important for many reasons. If we communicate well we are more likely to get what we want. Often disagreements and upsets are caused because communication is poor. It's easy to fall out with someone because you, the other person or both of you are not communicating well - not necessarily because you disagree.

Verbal and non-verbal Communication can be classified as two types:

1. Verbal communication
2. Non-verbal communication.

Verbal communication always uses words, spoken and written. Non-verbal communication is any form of communication that does *not* use words. Have a look at this table; it gives examples of both types of communication.

Complete the table in the space above

Positive or negative Communication can be either positive or negative. It is important for everyone in the workplace to be aware of their communication skills i.e. try make sure their communication is positive.

The wrong way Let's return to the earlier scenario where Steve was asked to service and clean the wheel balancer. Steve could have replied like this:

- "No, it's not my job!" Or even,
- "No!" And walked off.

Of course, that's perfectly true it isn't his job as we discussed earlier but how would you feel if you were Steve's workmate and spoken to in this manner. An obvious example of negative communication. The following screen shows a more professional and friendly way to approach this - positive communication.

A better way Let's now see what happens when Steve explains to Dave why he is unable to do the task. Explain yourself I think the difference in the two approaches is quite clear. In the first instance apart from responding in an unfriendly manner Steve

gives no explanation as to why he doesn't want to clean the wheel balancer. Dave would more than likely be offended and annoyed. In the second response Steve is not only polite but he explains why he can't do the job. He also shows that he's willing to learn.

Customer relations These two videos show a customer coming to a workshop. Which of these two responses would yours more likely be?

Customer relations 2 The first video was an example of negative communication and the second, positive communication. Notice the difference? Have a look at these two videos again by going back to the previous screen. Try to make a note, in the space provided below, of the differences. Then move forward to the next screen to see our suggestions. Be specific and remember that non-verbal communication can be just as important as verbal.

Add our notes about the videos in the space above.

Customer relations 3 These are our comments and observations perhaps you have found others.

Eye contact Let's take some of these points individually as they will be beneficial. Firstly, Eye contact - This is important because it shows that you are interested in what the person is saying and that you are trying to understand. It is warm and friendly.



However, this can be difficult for some people and we will look further at this later. No matter how difficult though, you should try to do it. It makes the other person feel that what they are saying is important to you. Also, it is easier for you to gauge whether or not they understand you if you can see their facial expressions.

Body language This is important for the same or very similar reasons. Slouching, leaning, fidgeting, folding your arms in a defensive, stand-off manner are all examples of negative body language and negative communication. On the other hand the opposite, standing or sitting upright and relaxed, is positive body language. Fidgeting can be very off putting not that you need to remain dead still and afraid to move. Relaxed gestures are fine and can aid communication.

Nodding Nodding in agreement is good because it shows the other person that you understand and/or that you agree in what

they are saying. Have you ever been in a situation where you were either explaining something difficult or saying something you thought the other person may disagree with? If the other person nodded I'm sure it gave you a sense of relief knowing that they understood or agreed with you.

Nervousness Some people are naturally shy and reserved. This can be a positive thing. People generally don't like others to be too loud, constantly talking and over confident. Quite often this behaviour can be a cover up for shyness and insecurity.

Be interested and listen If you are nervous or self-conscious, first and foremost, try to concentrate fully on what the other person is saying. Be genuinely interested. Show this by nodding and making eye contact. Being interested means you will truly be listening to what the other person is saying and that will help you to relax. It directs your attention from you to them. Really trying to listen and understand another will greatly reduce your feelings of self-consciousness.

Relaxation When you feel nervous, insecure or threatened your breathing becomes shallow. Try to take deep, slower breaths it will help you to relax. By feeling relaxed your confidence will grow. You will be in control of your body and voice rather than your body and voice controlling you. Remember to smile! It is so much easier to communicate with a friendly person. When you feel relaxed and confident communication is a very natural thing. It is unforced, sounds sincere and is more effective.

Take time As with learning all things developing new skills takes time. Some people learn certain skills more quickly than others. Practice makes perfect! Don't be too hard on yourself; trying too hard can make you feel more self-conscious and tense. Just relax.

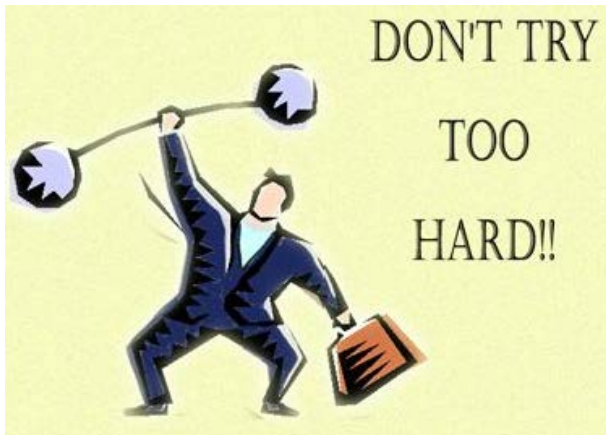

Written communication Don't worry you don't have to be a wonderful speller or excellent at English but it does really help if you have some basic skills. Poor written communication can take the form of, illegible handwriting, bad spelling/grammar. This can lead to:

- An unprofessional image
- Misunderstandings.

Misunderstanding A misunderstanding could lead to someone's safety being at risk. Imagine that you found the cables of a hoist were frayed and your report was so poorly written that it couldn't be understood!

Reporting problems When reporting problems always speak to the relevant person. We covered this in lines of communication.

However, to report a problem is one thing but to report it *effectively* is another. Always report problems to the appropriate person as soon as possible.

Verbal report 1 A technician finds that a piece of equipment is not working correctly and he needs to report this to the supervisor. Imagine that the supervisor is instructing a customer and the report is made something like this ...

Verbal report 2 Pete's attention is elsewhere and it is quite likely that he may not have heard or really taken it in. The technician should wait until Pete has finished speaking with the customer and then report the problem. Also, it would be rude to the customer to interrupt like this.

Written report It may be your company's policy to have any such problems written on a report form and given to the appropriate person. It's therefore necessary to write clearly and make sure that another person would understand what you are saying. A good point of practice then is to read what you have written and ask yourself this 'Will Julie/Jane/Steve/Mick be able to understand this?' This is where some very basic spelling and grammar is required.



Poor hand writing Look at this report filled in by a technician. 'That's a bit over the top', you may say, 'No one would write like that', but sometimes reports are really filled in like this. Aside from the obvious poor and illegible handwriting several boxes have been left blank. The date or time has not been entered and there is no telephone number or contact details for the client. Who is the message for?

Explain yourself clearly Here is another report made from a telephone conversation with a supplier, Morris Holdings. All the necessary boxes are filled in but ... what is it saying? If you can't read it the translation actually says 'Morris Holdings can't do cleaning delivery this Wednesday and can do it next time if we want can call Christine 01732 4691.' Well, you can probably get the gist of the message but it could be explained more clearly. On the next screen we hear this same telephone message and see a much more clearly written report. Clear in this case means hand writing, spelling, grammar and expression - saying what you mean.

Explain yourself clearly 2 'If you would pass this message on please. We're not able to make the delivery this Wednesday; unfortunately, it won't be until Wednesday of next week, the 21st. If that causes any problems you can call Christine on 01732 4671.'

Take time If you know that your handwriting is difficult to read then take greater care. Write more slowly. It may be easier if you write in capital letters. Remember you never became an automotive technician to be good at handwriting and English all you need is to be understood.

Adapt what you say It's also sometimes important to be able to adapt what you say to colleagues. If you have to speak to the receptionist or one of the office staff it's probably not a good idea to use highly technical language. 'Well why don't they ask, if they don't understand?' That's true but a big part of good communication means that you take on the responsibility of making yourself understood. Don't leave it to chance and don't rely on the other person asking you. People are much more likely to respond to you if you use their language.

Choosing your words Also the choice of words and how you say (or write) them is likely to be different when talking to your workmate than if you were talking to, say, a manager of the company. Is it appropriate to use first names for management in your workplace? In many cases it will be but sometimes, especially if you are part of a large organisation and don't often

Speak to a manager, it may be more appropriate to use Mr Mrs Ms or Miss.

Views and opinions Throughout life you will always meet people with different views and opinions to yourself. This will be no different in the workplace. So often poor working relationships are caused because people think they are right and the other is wrong. Remember, no one likes a 'know it all'.

Be open and flexible One of the best ways to learn is to be open to new ideas. This doesn't mean that you always have to agree with them but it is polite and professional to listen and consider what your work mate is saying. Don't always assume that you are right. Be flexible in your opinions. Again, by listening and really considering a different point of view shows that you value another person's thoughts and feelings. This in turn leads to a good working relationship.



Positive or negative approach Sometimes you may be in the right and the other person in the wrong but there are positive and negative ways of dealing with this. In the following scenario Ian and Mick, two technicians, are having a discussion over a fault on a customer's car.

Honouring commitments If you say you are going to do something do it! One of the worse things for damaging your career is to have a reputation of making 'empty promises' i.e. saying that you will do something and then not doing it. Quite often it's not case of being lazy or unwilling but,

- Forgetting
- Being too busy.

Forgetful The best way to remember to do something is to write it down. Perhaps your workshop may have a notice board or whiteboard or you may want to write it on a post-it note. At the very least decide on a time there and then when you are going to do the task. That way if you have the time set aside and firmly placed in your mind you are less likely to forget. Writing something down though is always the best option, especially if you can't do the task that same day.

Too busy Be realistic! Consider the following two points if you are asked, or before you volunteer, to do something:

- Do I have the time?
- How long will the job take?

Do I have time? Of course you will want to be seen as cooperative and willing, but sometimes you may just not have time. How do you approach this? A response like, 'No, can't, sorry don't have time' isn't likely to do you any favours. You need to explain your situation. Don't assume others will know, even if you think they should. Perhaps you may need to say that you

would like to but at the moment you really are too busy with such and such a task. Through discussion you may find that you can do the job with some help, or that the new job takes priority, or that it can be done later. Be aware of your limitations.

Seriously consider If you do make the commitment to do something then do seriously consider how long it is going to take you. What other jobs have to be done, give some time for the unexpected, e.g. other tasks that may arise, unforeseen problems, etc.

Summary In summary communication can be both verbal and non-verbal, spoken or written and positive or negative. The way we communicate in the work place can help either to build or destroy working relationships. Feeling reasonably confident and relaxed is important. And finally, Good Luck!



 Look back over the previous section and write out a list of the key bullet points here:

ENGINE SYSTEMS

ENGINE MECHANICAL

INTRODUCTION AND OPERATING CYCLES

Technology The modern motor vehicle engine is a complex machine and the power plant of the vehicle. The engine burns a fuel to obtain power. The fuel is usually petrol or diesel, although liquid petroleum gas (LPG) is sometimes used and specialist fuels have been developed for special purposes such as racing car engines.

Internal Combustion

Engine Motor vehicle engines are known as 'internal combustion' engines because the energy from the combustion of the fuel and the resulting pressure from expansion of the heated air and fuel charge is applied directly to pistons inside closed cylinders in the engine. The term 'reciprocating piston engine' describes the movement of the pistons, which go up and down in the cylinders. The pistons are



connected by a
rod to a

Air and Fuel The fuel is metered into the engine together with an air charge for petrol engines. On diesel engines, the fuel is injected into a compressed air charge in the combustion chamber. In order for the air and fuel to enter the engine and for the burnt or exhaust gases to leave the engine a series of ports are connected to the combustion chambers. The combustion chambers are formed in the space above the pistons when they are at the top of the cylinders. Valves in the combustion chamber at the ends of the ports control the air charge and exhaust gas movements into and out from the combustion chambers.

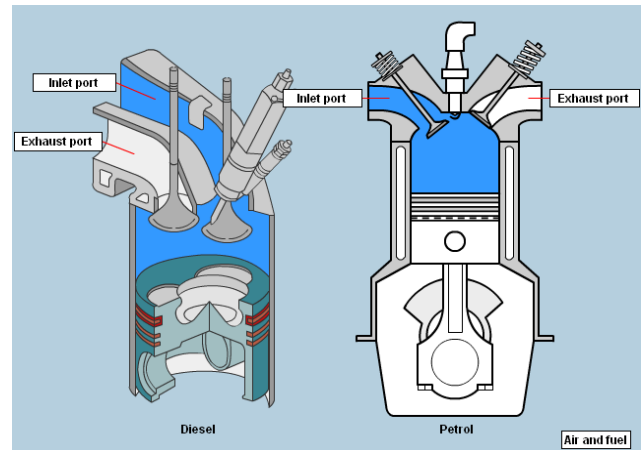

Poppet Valves The valves are 'poppet' valves having a circular plate at right angles to a central stem that runs through a guide tube. The plate has a chamfered sealing face in contact with a matching sealing face in the port. The valve is opened by a rotating cam and associated linkage and closed and held closed by a coil spring.

Add the labels as shown on screen:

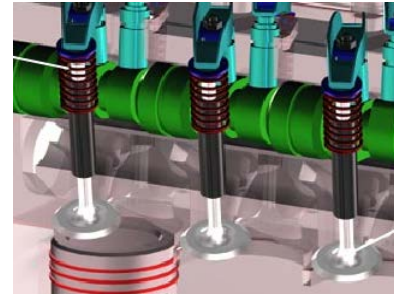

The Four-Stroke Cycle (or Otto cycle) □□□ The opening and closing of the valves and the movement of the pistons in the cylinders follows a cycle of events called the 'Four stroke cycle' or the 'Otto cycle' after its originator.

The Induction / Intake Stroke □□□ The first stroke of the four stroke cycle, is the induction or intake stroke when the piston is moving down in the cylinder from top dead centre (TDC) to bottom dead centre (BDC) and the inlet valve is open. The movement of the pistons increases the volume of the cylinder and air and fuel enters the engine.

The Compression Stroke □□□ The next stroke is the Compression stroke when the piston moves upwards in the cylinder. Both the inlet and exhaust valves are closed and the space in the cylinder above the piston is reduced. This causes the air and fuel charge to be compressed, which is necessary for clean and efficient combustion of the fuel.

The Combustion / Power Stroke □□□ Towards the end of the compression stroke, the fuel is ignited and burns to give a large pressure rise in the cylinder above the piston. This pressure rise forces the piston down in the cylinder on the Combustion or Power stroke.

The Exhaust Stroke □□□ Once the energy from the fuel has been used, the exhaust valve opens so that the waste gases can leave the engine through the exhaust port. To complete the exhausting of the burnt gases the piston moves upward in the cylinder. This final stroke is called the Exhaust stroke.

Four-Stroke Cycle □□□ The four-stroke cycle then repeats over and over again, as the engine runs.



Sketch the four phases of the four-stroke cycle here

The Induction or Intake Stroke □□□ On the induction stroke of a petrol engine, air and petrol enters the cylinder so the inlet valve in the inlet port must be open. On a diesel engine, air only enters the cylinder. A rotating cam on the camshaft provides a lifting movement when it runs in contact with a follower. A mechanical linkage is used to transfer the movement to the valve stem and the valve is lifted off its seat so that the inlet port is opened to the combustion chamber.

Cylinder Charge □□□ The air and petrol charge or air charge can now enter the cylinder. The inlet valve begins to open shortly before the piston reaches TDC. The exhaust valve, which is operated by its own cam in the same way as the inlet valve, is beginning to close as the piston passes TDC at the end of the exhaust stroke. Valve overlap helps clear the remaining exhaust gases from the combustion chamber. The incoming air charge fills the combustion chamber as the last quantity of exhaust gas leaves through the exhaust port. This is known as 'scavenging' and helps cool the combustion chamber by removing hot exhaust gases and gives a completely fresh air charge.

Top Dead Centre (TDC) and Bottom Dead Centre (BDC) The terms top dead centre and bottom dead centre are abbreviated to 'TDC' and 'BDC' respectively. They are used to describe the position of the piston and crankshaft when the piston is at the end of a stroke and the axis of the piston and crankshaft bearing journals are in a straight line and at 0° (TDC) and 180° (BDC) of crankshaft revolution. To the abbreviations are added the letters 'a' to indicate degrees 'after' TDC or BDC and the letter 'B' to indicate 'before' TDC or BDC.

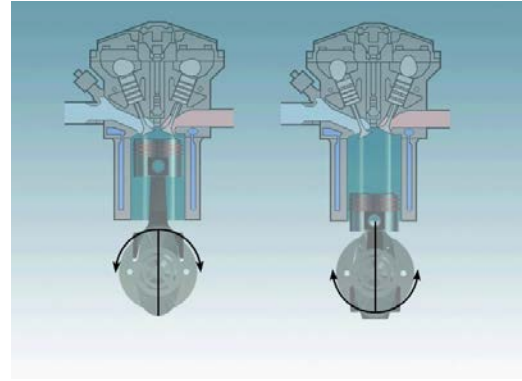

Engine Locations There are various configurations that manufacturers have used in the configuration of their vehicle powertrains. The engine can be front, mid or rear mounted and can be installed in-line (along the vehicle axis) or transverse (across the vehicle axis)

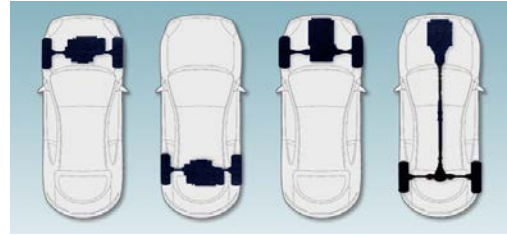

Positions for the engine

Engine Mounting in the Vehicle Frame The engine mounting system is important as it supports the weight of the engine in the vehicle installation, in addition, it counteracts the torque reaction under load conditions. The mounting system has to isolate the vehicle from the engine structure borne vibrations and generally, the engine mounts consist of steel plates with a rubber sandwich between to provide the vibration isolation. The mountings have appropriate brackets and fittings to fix to the engine and vehicle frame



Engine...



Mountings

Front Engine, Rear-Wheel-Drive Mountings

For a front engine, rear drive powertrain layout, the engine mounts are often at the centre position of the engine side, approximately at the engine centre of gravity. The engine mounts bear compression and shear forces in supporting the engine weight and torque. The rear of the engine is bolted to the transmission that is in turn supported at the rear end via a rubber mounting system. This 3 point type mounting is very common for this powertrain configuration.

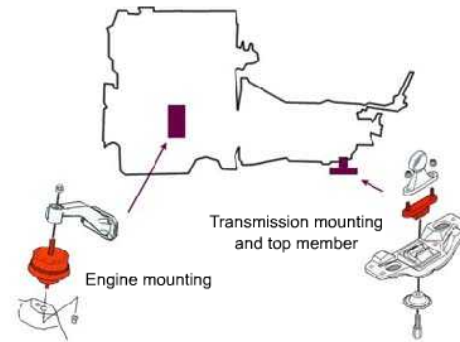

Front Transverse Engine, Front--Drive Mountings For a front wheel drive, transverse powertrain layout, the mounting system has to cope with weight of the engine, plus the torque reaction of the wheel torque. The mounting system therefore includes mountings to support weight and counteract torque separately. These are mounted at the top or bottom of the engine respectively

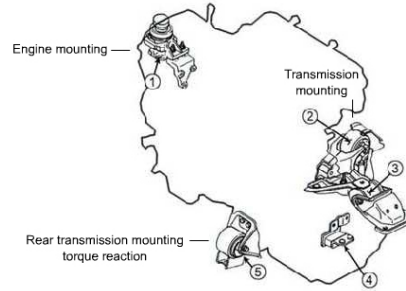

Hydraulic Mountings A trend in modern vehicles is the use of hydraulic engine mountings that have superior performance with respect to noise reduction when compared to rubber types. They are often used in luxury vehicles or diesel engine installations

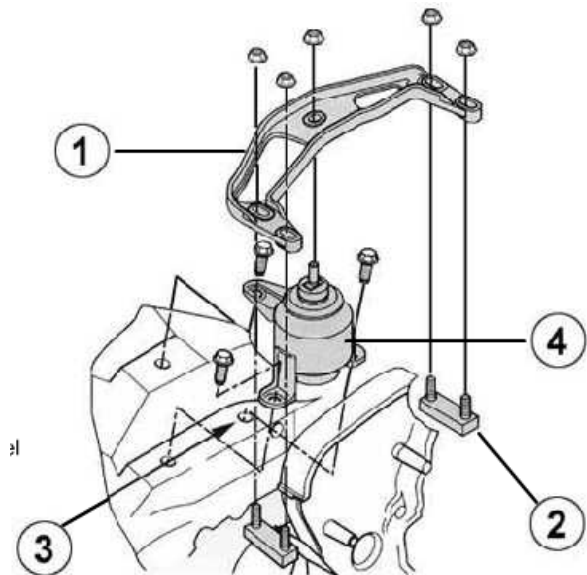

Two-Stroke Petrol Engine

Cycle All internal combustion engines have an induction, compression, expansion and exhaust process, for a four stroke engine, each of these processes requires half an engine revolution, so the complete engine cycle takes two complete engine revolutions. That is, there is a working and a non-working (gas exchange) revolution of the engine within the cycle. A two stroke engine combines two of the process in each half turn of the engine, thus, all processes are complete in one engine revolution and the engine has a power stroke with every revolution. In order to operate, the two stroke petrol engine uses the crankcase (piston underside) for induction of the fuel air mixture and transfer into the cylinder via ports in the cylinder barrel. The engine operation is as follows:

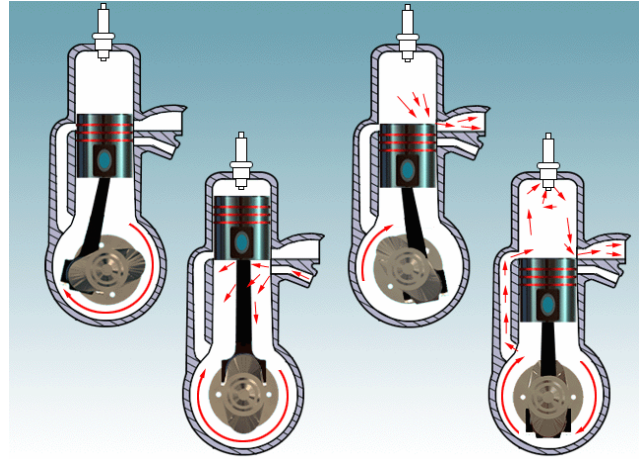

Upstroke - Piston moves upwards towards TDC, fuel/air charge trapped in the cylinder space above the piston is compressed and around TDC, ignited by a spark plug, this is the beginning of the power stroke. As the piston rises during the upstroke, the volume in the crankcase increases and atmospheric pressure forces the fresh fuel/air charge into the crankcase (under the piston)

Down stroke – Piston moves towards BDC as the power stroke begins, the expanding gases force the piston down the bore, producing torque at the crankshaft via the connecting rod. At the same time, the crankcase volume decreases and the fuel/air mixture is compressed under the piston. As the piston approaches BDC, the transfer port connecting the cylinder volume to the crankcase volume is uncovered by the piston. In addition, at the opposing side of the cylinder, the exhaust port is also uncovered.

This allows the fresh charge in the crankcase volume to transfer and fill the cylinder volume, at the same time, forcing the exhaust gases out of the cylinder via the exhaust port. The efficiency of this scavenging process is very dependent on the port exposure timing and the gas dynamics. Often the piston crown has a deflector to assist this process and to prevent losing fresh charge down the exhaust. Note that two stroke gasoline engines are normally lubricated via the provision of an oil mist in the crankcase. This is provided by oil mixed in with the fuel/air (pre-mixed or injected), hence the oil is burnt in the combustion process which produces excessive hydrocarbon emissions.

Developments Two stroke engines are generally more powerful for a given displacement due to the extra power stroke compared to a four stroke engine, the problem is that the expansion stroke is short and volumetric efficiency is poor, they are therefore less efficient. Also, exhaust emissions are higher than a four stroke engine.

Two-Stroke Diesel Engine Cycle

Large diesel engines are very often two-stroke types. Note that all four operating processes are executed in one, single engine revolution (induction, compression, expansion and exhaust). The diesel engine requires a charge of air that is compressed to raise its temperature above the self-ignition point of the fuel. This air charge is supplied by an air pump or pressure charging device (turbo or supercharger). The pressurized air from this device passes into the combustion chamber via ports in the cylinder wall. The exhaust gases leave the combustion chamber via cam operated poppet valves. The incoming charge forces the exhaust gases out via these valves and this provides the cylinder scavenging process.

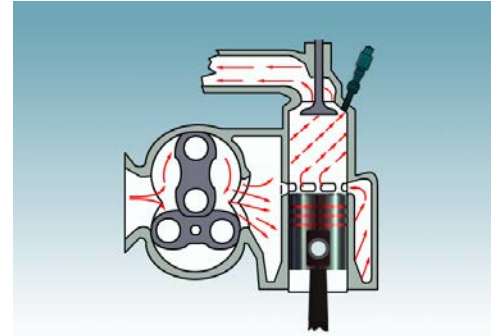

Inlet ports open and...

Down stroke The two stroke diesel engine cycle is illustrated in the diagrams. During the downwards movement of the piston, the hot expanding gases are forcing the piston down the bore, producing torque at the crankshaft, this is the expansion process. As the piston approaches BDC, the exhaust valve opens and the remaining pressure in the exhaust gas starts the evacuation of the gases in the cylinder via the open valves. As the piston moves further down to BDC, inlet ports are exposed around the bottom part of the cylinder bore, these allow the pressurised, fresh air charge from the air pump (or turbocharger) to fill the cylinder, evacuating the remaining exhaust gas via the valves and completing the exhaust and induction cycles

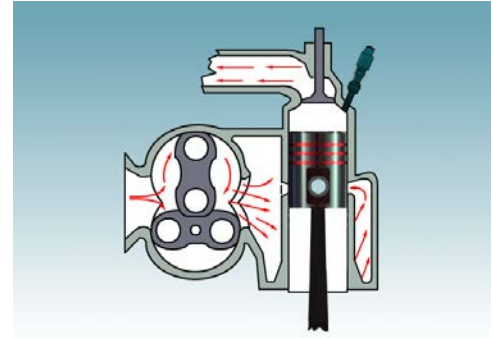

Closed

Upstroke At BDC, the cylinder contains a fresh air charge and the piston then begins to move up the cylinder bore. The inlet ports are closed off by the piston movement and the air charge is trapped and compressed due to the decreasing volume in the cylinder. At a few degrees before TDC, the air temperature has risen due to the compression process and fuel is injected directly into the combustion chamber, into the hot air charge, where it vaporises, burns and generates thermal and pressure energy. This energy is converted to torque at the crankshaft via the piston, connecting rod and crankshaft during the down stroke.

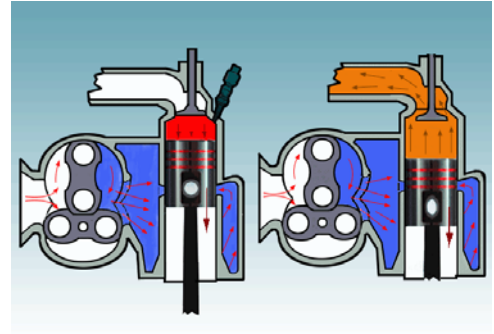

Diesel two-stroke cycle

Rotary or Wankel Engine The rotary engine has been used in a limited number of passenger car applications. The engine uses a complex geometric rotor that moves within a specially shaped housing. The rotor is connected to the engine crank shaft and turns within the housing to create working chambers. These are exposed to inlet and exhaust ports to allow a fuel/ air charge in, compress it and expand it (thus extracting work), then evacuate the waste gases and restart the cycle. The rotor has special tips to provide a gas tight seal between the working chambers (similar function to piston rings)



Rotary engine

Summary □□ This animation shows a view from above of the four-stroke cycle operating in a four cylinder engine.

Note the firing order of 1-3-4-2 and how each cylinder runs through the four-strokes: induction, compression, power and exhaust - or, suck, squeeze, bang, blow!

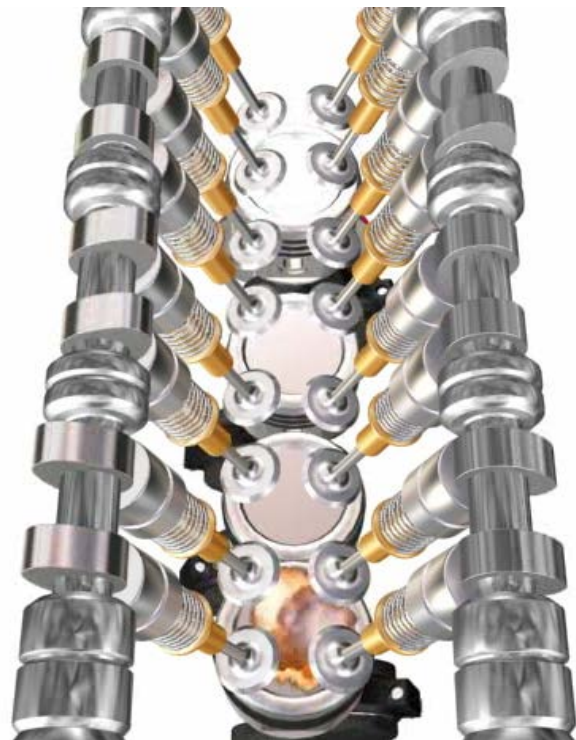



Explain what is meant by 'internal combustion'.



Explain the four-stroke cycle.



Look back over the previous section and write out a list of the key bullet points here:

ENGINE COMPONENTS

Crankshaft and Camshaft □□□ The camshaft rotates once for the two revolutions of the crankshaft during the four stroke cycle. The drive from the crankshaft to the camshaft has a 2:1 ratio produced by the numbers of teeth on the driven and driver gears. Rotational data for the camshaft is usually given as degrees of crankshaft rotation and this needs to be considered in relation to the four-stroke cycle. The four-stroke cycle occurring over two full revolutions of the crankshaft has a 720° rotational movement.

Valve Timing Diagram □□□ Looking at the four-stroke cycle and the relationships of the crankshaft rotation, the piston position in the cylinder and the opening and closing of the valves is best observed by looking at a valve timing diagram. This diagram is one method of providing data for valve opening and closing positions.

Valve Timing Data Valve timing data is given in engine workshop manuals as degrees of crankshaft revolution. This can be as written data or by means of valve timing diagrams. In the most popular valve timing diagram two circles, one inside the other, are used to represent the 720 degrees of crankshaft rotation through which the crankshaft moves for a complete cycle. Each stroke is represented by an arc of 180 degrees with induction and compression on the outer circle and combustion and exhaust on the inner circle. The valve opening and closing positions are marked and the duration of crankshaft rotation displayed by a thicker line.

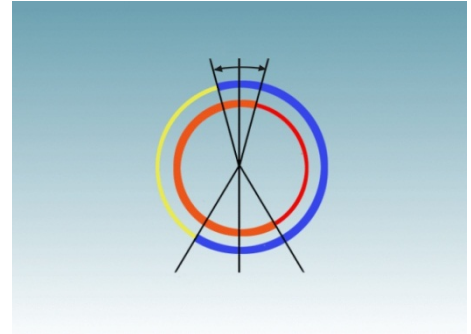

Circular valve timing diagram

Angular, Spiral or Linear Diagrams

Other valve timing diagrams can be straight line or spiral representations for crankshaft rotation. Valve timing data is needed for checking engines where unusual symptoms exist and if timing marks on the crankshaft and camshaft drive gears are unclear or missing.

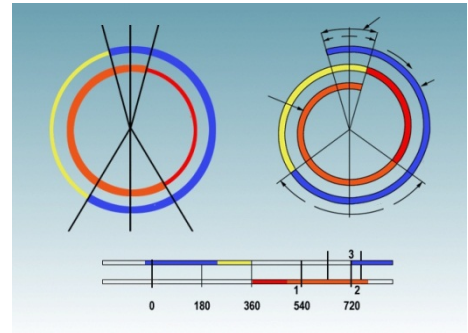

Timing diagrams

Valve Timing From the valve timing diagrams it can be seen that the valve opening and closing positions do not occur within the 180 degrees of crankshaft rotation for each stroke of the four-stroke cycle. For instance, towards the end of the exhaust stroke, the inlet valve begins to open and this is before the exhaust valve has closed.

Exhaust Valve The exhaust valve finally closes as the piston moves down on the induction stroke.

Inlet Valve The inlet valve closes as the piston is rising on the compression stroke.

Valves The exhaust valve opens before the end of the combustion stroke. The opening and closing positions of the valves are special to individual engines and is matched to other design and performance requirements.

Valve Lead, Lag & Overlap

The terms applied to the valves when opening before and closing after the start of a stroke and when both valves are open together are called 'lead', 'lag' and 'overlap' respectively. The overlap position is often referred to as 'valves rocking' and can be used as a rough guide as to when a piston is at top dead centre (TDC).

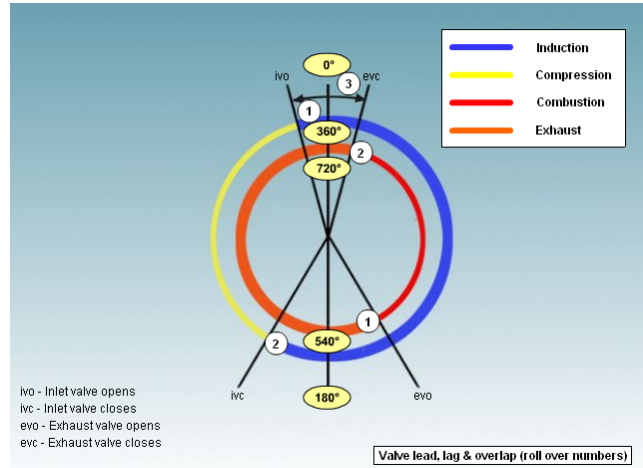

Summary What is happening within the four strokes is more complex than their simple descriptions and therefore it is important to study them in greater depth.



Construct a valve timing diagram from the following information:

IVO 5 BTDC, IVC 28 ATDC

EVO 18 BBDC, EVC 6 ATDC



Look back over the previous section and write out a list of the key bullet points here:

ENGINE OPERATING DETAILS

Atmospheric Pressure The air above the Earth's surface is a fluid that exerts a pressure on all points around it. This is due to the weight of the air acting down upon the Earth's surface and this, in turn, is because of the earth's gravitational force pulling it down. This creates a pressure is known as atmospheric pressure and is approximately 1 bar or 15 pounds per square inch

Naturally Aspirated Engine A naturally aspirated engine relies on atmospheric pressure to charge the cylinder with gas (air or air/fuel mixture) ready for the combustion process. As the piston moves down the cylinder (from TDC to BDC). The volume increases and this causes the pressure in the cylinder to reduce, becoming lower than atmospheric pressure. This creates a pressure difference between the inside and outside of the cylinder, and due to this, the atmospheric pressure (the higher pressure) forces gases into the cylinder (where there is lower pressure) until the pressure is balanced. Note that any restriction to the flow of gas will reduce the effectiveness of the cylinder charging process

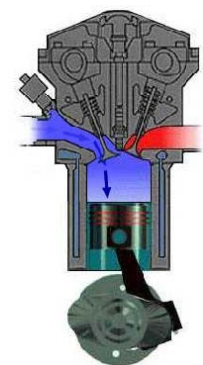

Inlet of
fuel-air
mixture

Volumetric Efficiency This is a measure of the efficiency of the cylinder charging process during the induction stroke.

Theoretically, the cylinder should be completely filled with a mass of gas but in practice this never happens due to flow losses and inefficiencies. Therefore, the volumetric efficiency is a measure of the actual amount of gas induced compared to the theoretical amount (which is the mass required to completely fill the cylinder volume) and is expressed as a percentage. It is calculated as: (the actual mass of air / the theoretical mass of air) x 100%

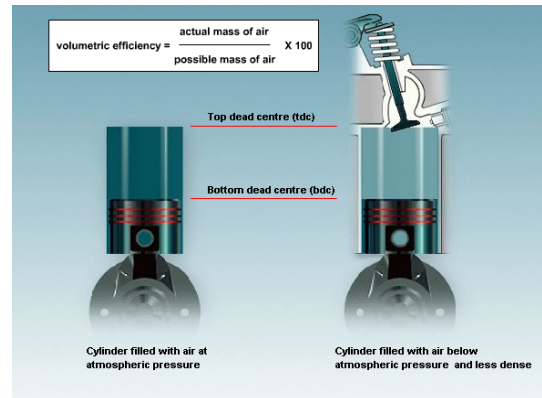

Breathing or Aspiration The more efficiently the engine cylinders can fill with gas, the more air, or fuel/air, is available for the combustion process and this improves overall engine efficiency. The process of getting gases into and out of the engine is known as 'aspiration' or 'engine breathing'.

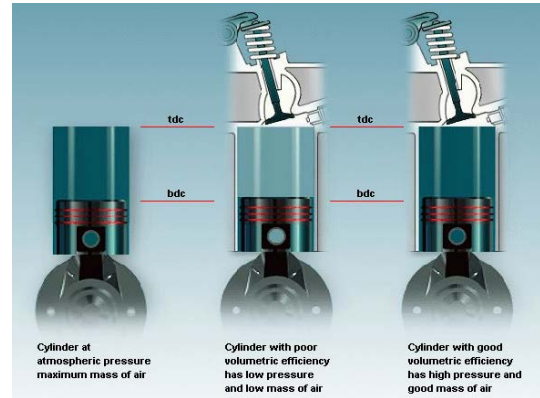

Petrol and Diesel Combustion in the engine cylinder takes place because of a chemical reaction between the carbon and hydrogen in the fuel and the oxygen in the air. This reaction releases energy from the fuel in the form of heat that generates pressure in the cylinder to force movement of the piston. In order to achieve efficient combustion, the quality of the fuel/air mixture is important. That is, how evenly mixed the fuel droplets are in the induced air. Movement of the air as it enters the cylinder is important for this process and the requirements are different for petrol and diesel engines. The required air movements for each engine type are created by careful design of the components that form the inlet tract and combustion chamber.

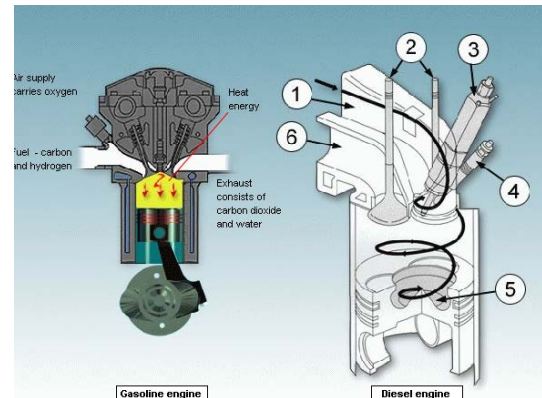

Inlet Valve The inlet valve opens and closes according to piston position and controls the incoming gas charge into the engine. It generally remains open for a small time period after the piston has reached BDC (i.e. beyond the end of the inlet stroke). This allows the energy of the moving gas column in the inlet tract to assist in the cylinder charging process which helps to increase volumetric (and engine) efficiency

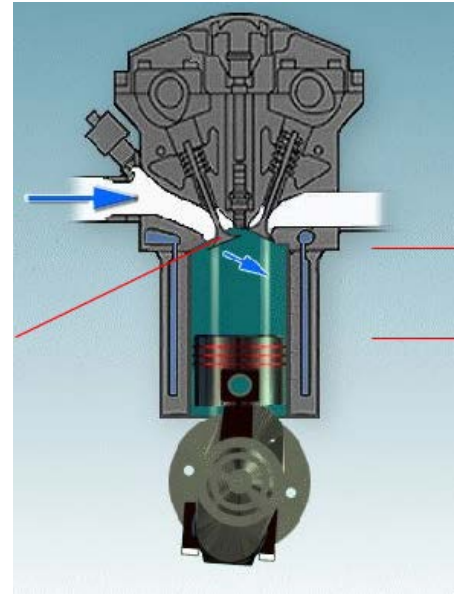

The Compression Stroke □□□ After the combustion chamber has been charged with gas (air or fuel/air) during the induction stroke, the cylinder inlet and exhaust valves are both closed and seal the combustion chamber. The piston begins to rise in the cylinder, thus reducing the volume of the cylinder space and hence increasing the pressure of the trapped gas charge in the cylinder prior to combustion. The opening and closing of the valves is executed in sequence via the engine valve gear, synchronized with the 4-stroke cycle and piston position.

Piston Rings It is important that the closed cylinder is sealed properly to maintain the appropriate pressures in the cylinder during the working cycle. Any losses in pressure would significantly reduce the efficiency of the engine. In order to seal the piston and bore, piston rings are fitted into radial grooves near the top of the piston and provide the gas tight seal between the moving piston and the cylinder bore. When the cylinder volume is reduced during the compression stroke, the trapped gas is compressed and the amount of compression is known as the compression ratio.

Compressing the charge prior to combustion allows more oxygen or fuel/oxygen in the cylinder than would otherwise have been available without compression and this improves combustion efficiency.

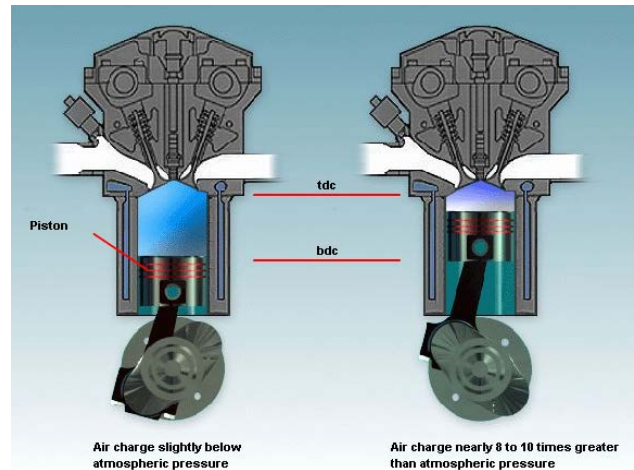

Generally, most spark ignition engines have a compression

Temperature Rise During Compression (Petrol) □ During compression of the fuel/air mixture in a petrol engine, heat energy and kinetic energy (due to gas movement) are imparted into the mixture due to the reducing volume and rising pressure. This creates a significant temperature increase and the magnitude of this increase depends upon the speed of the compression process and the amount of heat rejected to the surroundings (via the cylinder combustion space, walls, head etc.). The temperature rise elevates to a point just below the self-ignition temperature of the fuel/air charge, which will combust at or above the flash-point when ignited via an external source (i.e. the spark plug). Note that if the temperature of the mixture was too high, spontaneous, self-ignition could occur and this would be a limiting factor for the maximum compression ratio in a petrol engine.

Temperature Rise During Compression (Diesel) □□□ In a diesel engine, the compression process must create sufficient energy to cause the temperature of the compressed gas (air) to rise above the self-ignition temperature of the fuel that is injected into the cylinder at the end of the compression stroke.

Air Turbulence Inlet charge movement is particularly important in a diesel engine, in order to ensure that the fuel droplets have sufficient oxygen for complete combustion. The required air flows during the induction and compression processes are created by the design of the inlet tract and combustion space. Generally, there are two designs of combustion chamber in common use and these are named, as such, due to the position in the chamber where the fuel is introduced. They are known as direct and indirect injection

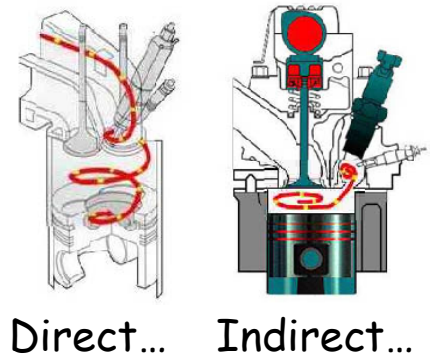

Direct Injection A Direct injection combustion chamber has a 'bowl' formed in the piston crown. This is designed to promote a tumble movement of the incoming air mass; this helps to ensure good distribution of the fuel in the cylinder and reduced soot emissions.

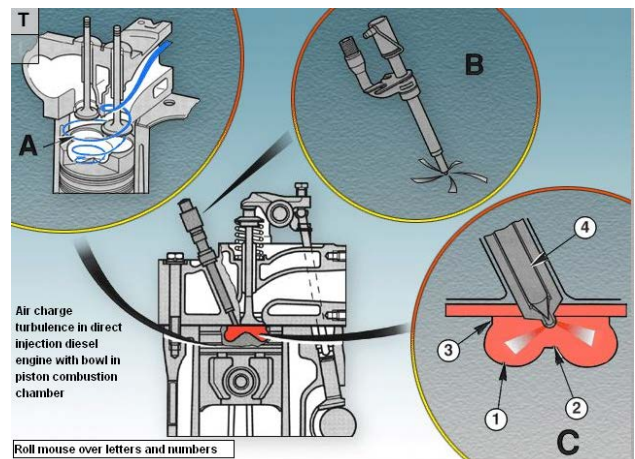

Indirect Injection The indirect type combustion chamber incorporates a pre-combustion chamber within the cylinder head. The compressed inlet charge is forced into this chamber at high-velocity and pressure. This creates a swirl movement that ensures complete mixing of fuel droplets with air for maximum combustion efficiency. During the combustion process, the burning gases are ejected from this chamber with high pressure and energy. This ensures sufficient turbulence in the main combustion chamber for efficient combustion.

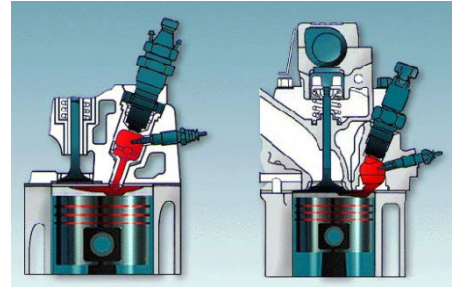

Pre-combustion chamber and Swirl chamber

Compression Ratios The compression ratio of a direct injection engine is typically between 16 and 21:1. This is sufficient to raise the induced charge temperature for self-ignition of the fuel under all engine operating conditions without creating excessive combustion noise (or diesel knock). Indirect injection engines have higher compression ratios of 22 to 25:1. This is necessary to generate the extra heat energy required due to losses via the increased surface area of the cylinder head. Diesel knock is less apparent in indirectly-injected engines as the energy release is more controlled and less spontaneous.

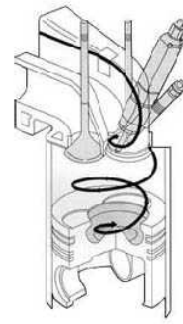

Compression ratios vary...

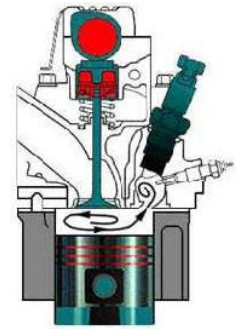

With different engine types

The Combustion or Power Stroke □ After compression of the inlet charge, combustion of the fuel creates heat and pressure energy, which is imparted on the piston to generate mechanical work. In a petrol engine, this process is initiated by the high voltage arc at the spark plug electrodes in the cylinder.

Combustion or Power Stroke The diesel engine is designed to produce compression pressures that generate sufficient heat in the cylinder to ignite the fuel as it is injected into the combustion chamber. This is known as compression ignition (CI). Petrol engines are generally known as spark-ignition (or SI) engines. During the combustion stroke, the engine power output or work is generated, hence the name 'power' stroke in the 4-stroke cycle of induction, compression, power and exhaust. Engine combustion is a fundamental process in the operation of the engine. This process must be efficiently executed and controlled via the engine sub-systems (fuel, air, ignition etc.) to ensure best efficiency and performance, with minimum harmful exhaust emissions.

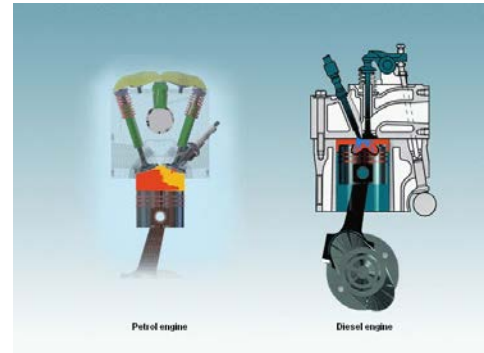

Complete Combustion of Fuel and Oxygen Combustion in the cylinder of an engine is a chemical reaction process between carbon and hydrogen in the fuel and oxygen present in the induced air. The carbon and oxygen combine to form Carbon Dioxide (CO_2), the hydrogen combines with oxygen to form water (H_2O). Nitrogen passes through the engine as long as the combustion chamber temperatures remain below critical limits.

Incomplete Combustion of Fuel and Oxygen If the combustion process is not efficient, incomplete combustion will result and this produces Carbon Monoxide (CO). If combustion chamber temperatures are high, oxides of Nitrogen are produced (NO_x). These are both harmful pollutants and their emissions from Motor Vehicles are closely regulated and controlled by environmental protection agencies and bodies around the world.

Ignition Timing The combustion process should occur in a rapid but controlled manner. The flame propagation and energy release in the cylinder should have a predictable, stable behaviour depending on the engine operating conditions. The timing of the spark ignition is critical to achieve appropriate energy release for maximum efficiency in the energy conversion process that takes place in the combustion chamber. The burn duration of the fuel varies according to engine conditions; therefore, the spark must be adjusted to occur at the correct time, according to these conditions, to get the optimum torque from the engine. The optimum spark advance for a given engine condition is known as Minimum Spark Advance for Best Torque (MBT)

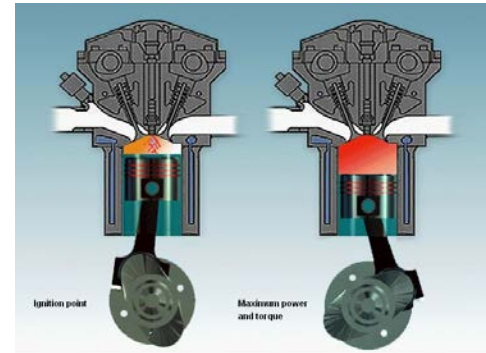

Petrol The quality of Petrol is measured by a parameter called the 'octane' rating and this gives an indication of the fuels resistance to engine 'knock' or uncontrolled, spontaneous combustion, which causes engine damage. The higher the octane rating, the slower and more controlled the fuel burns and hence, the greater the resistance to 'knock'. The octane rating of the fuel determines the limit of ignition advance for a given engine speed and load condition. Therefore, it is particularly important to always operate the engine on the correct fuel, to prevent damage to the engine due to 'knocking'.

Mixture Strength A

chemically correct air and fuel ratio mixture must exist in order to ensure that sufficient oxygen is present to completely combust all of the fuel.

This is known as mixture strength and is ratio of air mass to fuel mass. For most fuels, the correct ratio is approximately 14.7 air mass to 1 part fuel mass. If more air is present then the mixture strength is known as 'weak'. If less than a 14.7 air/fuel ratio, then the mixture strength is known as 'rich'. Weak and rich mixtures are less than optimum for the engine, although under certain conditions the mixture strength is adjusted by the engine control system according to demand. For example, for full power a slightly rich mixture is

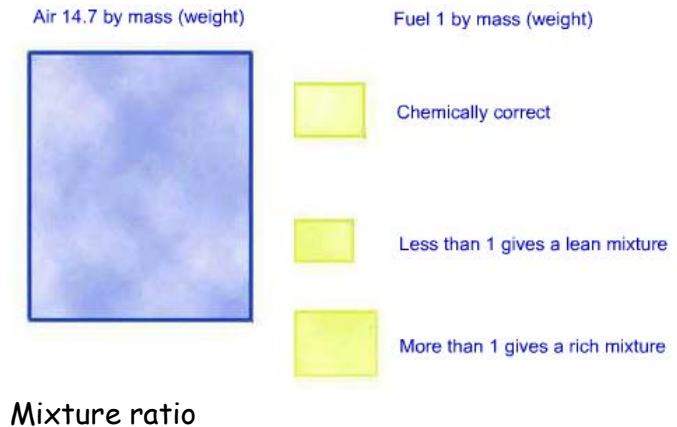

needed and this is provided when the engine is at full

Cylinder Pressure in a Petrol Engine

The combustion process creates energy within the cylinder in the form of heat from the burning fuel/air mixture. Due to the enclosed nature of the cylinder, this heat energy creates a pressure rise in the cylinder above the piston. This pressure, applied over the piston area, in turn, creates a force pushing down on the piston and turning the crankshaft via the connecting rod, thus producing torque at the crankshaft. The pressure in the cylinder is shown plotted against cylinder volume in the diagram. This is known as an indicator diagram.

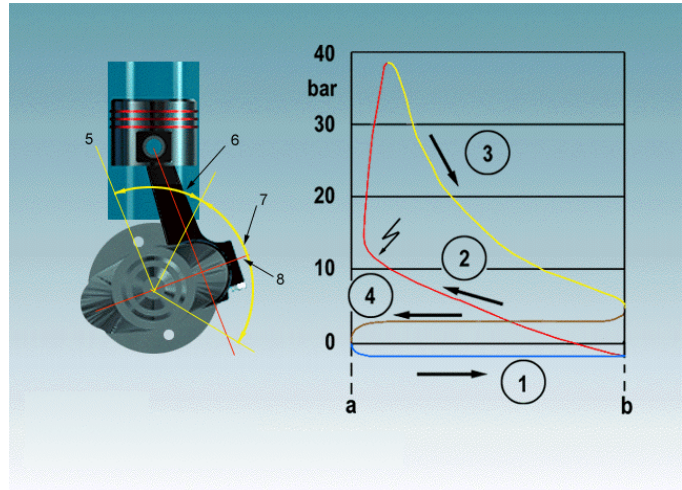

Petrol engine figures - Diesel figures are approximately double

Cylinder Pressure in a Diesel Engine The torque at the crankshaft is a function of the cylinder pressure and crankshaft angle; the maximum torque is produced when the connecting rod and crankshaft main/big-end bearings are at right angles (i.e. 90 degrees crank rotation from TDC position) Note that at TDC, any pressure on the piston produces no work as there is no turning moment (torque), just a force pushing down on the bearings.

Ideal Combustion The ignition and fuel settings of an engine are set by the manufacturer at the optimum position to achieve the best compromise of performance, economy and minimal exhaust emissions. With respect to combustion, it is important that the maximum cylinder pressure and energy release occur at the correct angle. Damage to the engine can occur if this happens too early or late in the engine cycle. An example is early ignition; this causes engine 'knock' and damages the piston if allowed to occur for any significant period of time.

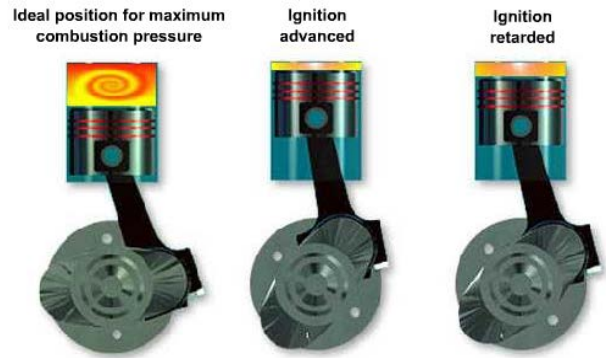

Pinking This is a characteristic noise caused by pre-ignition or early ignition of the fuel/air mixture. Early ignition causes an early pressure rise that is applied to the piston at TDC. At this crank angle, no engine torque can be produced and this means that all the combustion energy is applied directly to the engine mechanical components (piston crown, bearings etc.), causing them to generate the 'pinking' noise. Although the noise is quite subtle, the forces are massive and cause considerable damage to the engine.

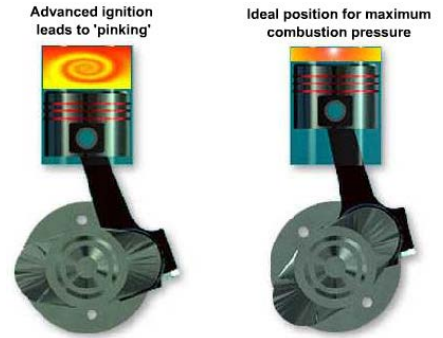

Advanced Ignition When 'pinking' occurs, the combustion energy precipitates through the engine components causing damage. In addition, heat is generated that is not dissipated normally and this causes excessive temperature of engine components (pistons, valves and valve seats for example) and consequent heat related damage.

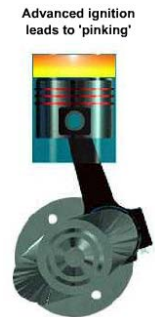

Retarded Ignition Over retarded ignition causes incorrect timing of the energy release from the fuel that, in turn, means less energy to do work and therefore more energy to dissipate via the cylinder boundaries. This causes an increase in engine temperatures, damages components and reduces overall engine efficiency. This excess energy also has to be rejected via the exhaust and this causes increased exhaust gas temperatures that can damage exhaust valves and seats, as well as exhaust gas components (catalytic converter).

Retarded ignition leads to overheating and component damage

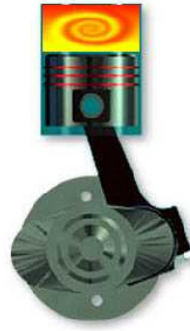

Ideal position for maximum combustion pressure

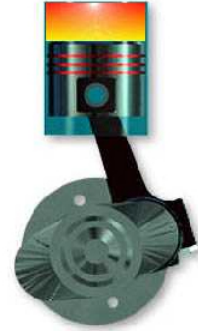

Diesel Combustion Combustion in a diesel engine begins very rapidly as the fuel is being injected into the combustion chamber and heated. This causes a rapid energy release that generates the characteristic 'diesel' engine noise. For this reason, a simple diesel engine is noisier than the equivalent petrol engine. The combustion process is most rapid in a direct injection diesel engine and due to this, combustion losses are minimal and these are the most fuel efficient type of internal combustion engine seen in road vehicles.

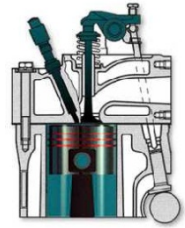

Indirect Injection Diesel Engines

Combustion is not fully completed in the pre-chamber before the combustion gases are expelled into the cylinder and continue the combustion process in the main combustion chamber. The increased surface area means that more heat from combustion is lost to the cylinder boundaries (walls, head etc.) when compared to the direct injection type. They are, though, quieter in operation due to the longer, slower combustion process.

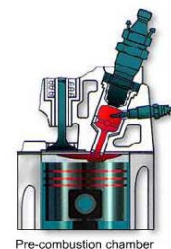

Pre-combustion chamber

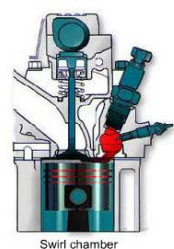

Swirl chamber

Exhaust Gas Recirculation (EGR) System Diesel engine always operate with excess air (or weak mixture) and with high exhaust gas temperatures, this oxygen combines with Nitrogen to form the pollutant NO_x (Oxides of Nitrogen). Exhaust gas recirculation (EGR) is often used to reduce cylinder temperatures and to reduce the amount of oxygen in the cylinder air charge, thus preventing the formation of NO_x .

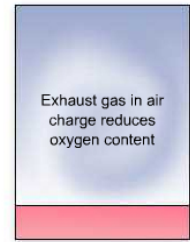
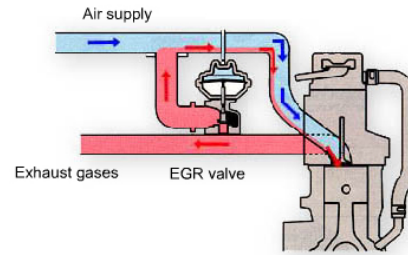

Cylinder charge with exhaust gas recirculation

Combustion Phases For diesel engines, there are three main phases in the combustion process. The first is the delay phase as the fuel absorbs heat from the cylinder air charge and vaporises. The next phase occurs when the fuel has reached a sufficient temperature to self-ignite, this causes combustion and the flame front propagates rapidly out across the piston crown. This is where the rapid energy release occurs and causes the characteristic diesel engine noise. Once initial burning of the fuel takes place, continued injection of fuel provides a controlled burning and energy release to provide sustained pressure on the piston and good torque generation at the crankshaft.

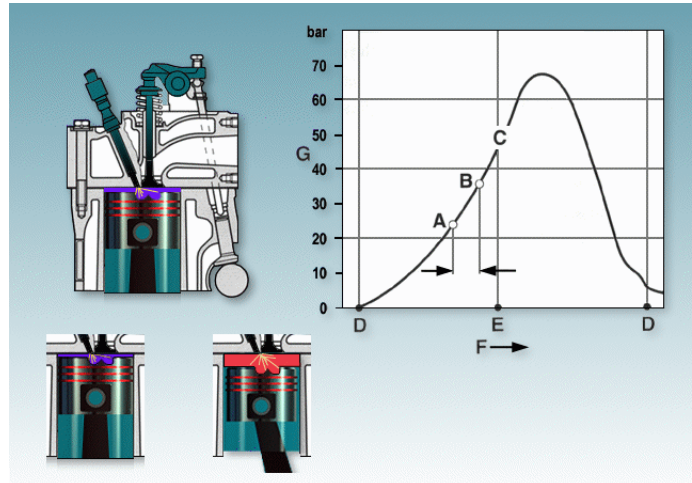

Phases of combustion

Good Combustion Efficient and effective combustion promotes an engine with good power output and with minimal harmful emissions. This can only be achieved when the engine mechanical parts are in good condition and, the engine control systems for fuel delivery, ignition and emission control are correctly optimised and set.

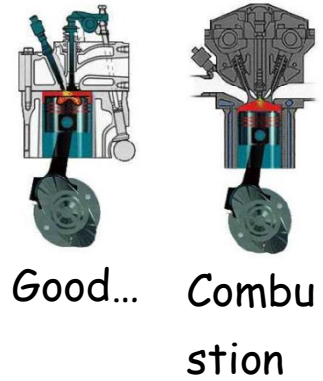

The Exhaust Stroke At the end of the power stroke, as much energy as possible has been extracted from the fuel and converted to mechanical work at the crankshaft. The next part of the working cycle is to reject the exhaust gases and their remaining heat energy from the cylinder. This process is controlled via the exhaust valves, which open around the end of the power stroke to vent the cylinder combustion gases to atmosphere via the exhaust system. Typically, the exhaust valves opens before the end of the power stroke to allow the remaining pressure energy in the end gases to assist in evacuating the cylinder.

Exhaust Valve The exhaust valve is opened via the engine valve gear and is synchronised with the engine operating cycle. Opening the exhaust valve before the end of the power stroke assists in the process of evacuating the cylinder volume efficiently. During the exhaust stroke, the piston rises from BDC to TDC, thus the cylinder volume decreases and this ejects the exhaust gases out through the exhaust valve. Generally, the inlet valve opens before the end of the exhaust stroke and this creates a certain amount of time when both inlet and exhaust valves are open. This allows the kinetic energy of the exiting exhaust gases to assist in drawing the fresh gas charge into the cylinder.

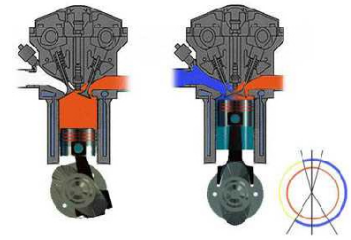

Timing diagram



Describe the effects of incorrectly set ignition timing.



Look back over the previous section and write out a list of the key bullet points here:

ENGINE TERMINOLOGY AND SYSTEMS

Technical Terms The following are some of the technical terms that are used to describe features of the engine:

Engine capacity - This is the total, combined, displaced volume of all engine cylinders as a single value stated in units of cubic capacity. Generally this is given in cubic centimetres (cm³) or litres. In America, engine capacity is normally stated in cubic inches (in³)

Swept volume - This is the volume of a cylinder bore between the TDC and BDC piston positions, excluding the volume above the piston at TDC

Clearance volume - This is the volume above the piston at TDC, note that it is the volume of the combustion chamber itself.

Bore - This is the diameter of the engine cylinder.

Stroke - This is the total linear distance travelled by the piston in the bore between TDC and BDC positions. Note that it is twice the crankshaft throw.

Compression ratio - This is the total volume of the cylinder at BDC (swept + clearance volume), expressed as a ratio of the volume of the cylinder at TDC (clearance volume).

The information on cylinder dimension can generally be found in workshop or manufacturer manuals. In addition, these values can be measured directly or derived via calculations.

Swept Volume This can be calculated via the formula: $(l\pi d^2)/4$, d = cylinder bore and l = stroke. Note that units of bore and stroke must be consistent. Engine volume is mostly stated in litres by manufacturers but remember that 1000cc (cubic centimetres) equals 1 litre. The total engine displacement is the sum of all cylinders individual displacements.

Compression Ratio The formula used to calculate the compression ratio (CR) is:

$$CR = (Vs + Vc)/Vc$$

Where CR = compression ratio

Vs = swept volume

Vc = clearance volume

Note correct order of preference when carrying out this calculation (brackets first - BODMAS).

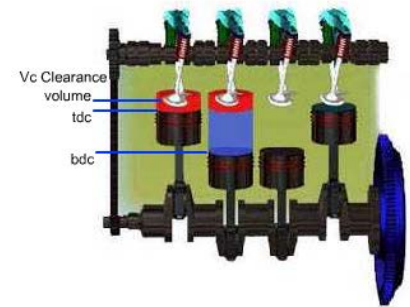

Torque Two common terms used when expressing engine performance characteristics are 'torque' and 'power'. Torque is an expression relating to work and is a measure of the turning force provided by the engine. Torque output can vary independent of engine speed and is a measure of the load on the engine. The units of torque are Newton metres (Nm) for SI units and Pounds/foot (lbs/ft) in Imperial units. Power is a derived unit and relates to the rate of work done, or the work done per unit of time. For an engine, the power is a product of torque and speed. Power output is given in Kilowatts (KW) or Horsepower (HP). Engine power is normally stated as measured at the flywheel, via a dynamometer or brake, hence the term 'brake horse power'.

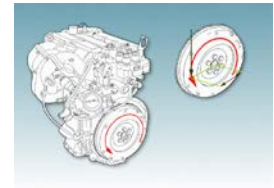

Torque and power

Engine Performance Curves

Engine manufacturers often publish performance data in a graphical form showing torque and power curves against speed. Two examples are shown here. Note that a petrol engine generally produces more power, at higher speed. A diesel engine produces more torque at lower speeds.

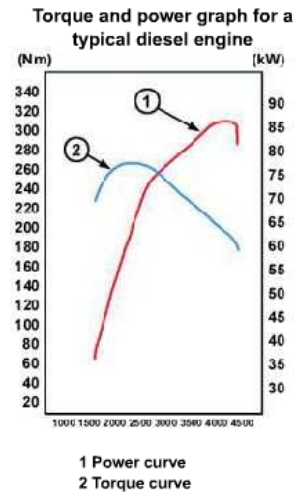
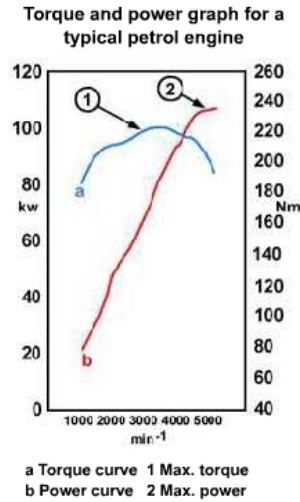

Optimum Cylinder Capacity The optimum size of an individual engine cylinder is a compromise of a number of technical factors. The optimum displacement for a cylinder is generally found to be between 250 cm^3 and 600 cm^3 for road vehicle applications. In this range, the combustion chamber size, surface area and individual components size (pistons, valves etc.) produce an engine with optimum efficiency with respect to fuel consumption and emissions. Typically, engines with total displacements in the range of 1 to 2.5 litres have 4-cylinders. Note though that the number of cylinders also has an effect on the manufacturing costs of an engine

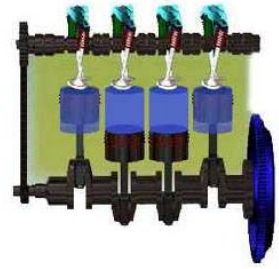

Displacement

Power Strokes per Engine Revolution The number of power strokes per revolution can be found by dividing the number of engine cylinders by two (for a 4-stroke engine). The greater the number of cylinders, the smoother the torque delivery due to reduced peak torque firing pulses from each cylinder and the increased number of firing strokes per revolution. Over 2 litres, six cylinder engines give smooth power delivery with optimum cylinder displacement sizes. An in-line six cylinder has a relatively long crankshaft that can be difficult to accommodate in a transverse engine installation layout, therefore by using two banks of three cylinders in a 'vee' configuration, total length is reduced and torsional rigidity of the crankshaft is improved.

The engines flywheel acts as an energy buffer due to its inertia. Energy stored in the flywheel maintains rotation between firing pulses and acts as a damper to smooth torque peaks as each cylinder fires.

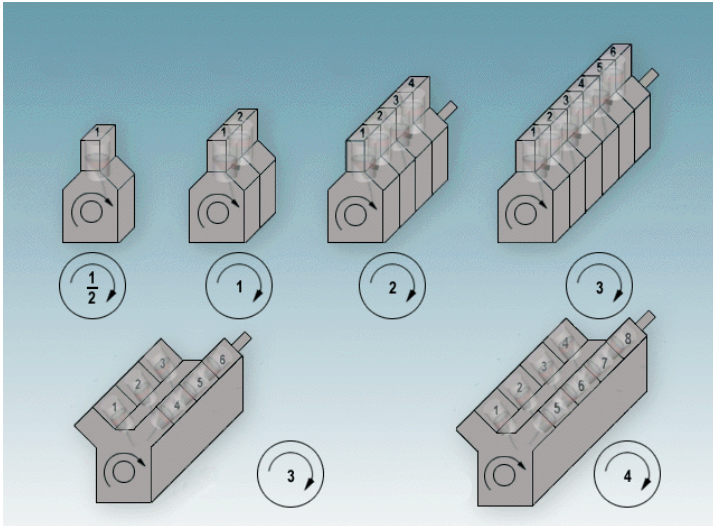

Cylinder layouts and power strokes

Component Technology This section explores various different engine designs and configurations found on modern road vehicles. The most common is discussed first. This is the four cylinder, four stroke, transverse installation layout incorporating overhead camshaft (OHC) petrol engine. This engine design and layout allows for a comprehensive repair program, including a complete overhaul.



Engine designs vary

Four-Cylinder, Four-Stroke Diesel Engine The next engine design to be considered is the four cylinder, four stroke, Overhead valve (OHV) indirect injection diesel engine. This engine is of traditional design and construction and facilitates straight forward repairs and overhaul. Diesel engines are generally more strongly constructed due to the higher cylinder pressures and forces.



Diesel engine

Special Oils Diesel engine emissions produce acidic elements that can react with certain engine components. Diesel specific engine oils are designed to neutralise this acidity via additives and should always be used. Corrosion and pitting of internal engine components can occur due to lack of regular oil changes.

V-6 4-Stroke 24-Valve Dual-Overhead Camshaft The third engine type to be considered is the vee-six cylinder, four stroke, twenty-four valve, double overhead camshaft (DOHC) design. This is a modern generation engine produced with close tolerance components manufactured with special tooling. This is necessary to achieve the required performance with respect to emissions and power. Therefore, it is not possible to repair or recondition this engine via traditional techniques (re-bore and pistons). Pistons and bores are matched with fine tolerances and therefore, major engine repairs are effected via replacement of the engine with a reconditioned 'short' motor. Also, all repair and adjustments must be carried out exactly in accordance with the manufacturer's instructions.



DOHC

Cylinder Arrangement

There are numerous engine configurations with respect to the arrangement of the engine cylinders, the number of cylinders, position and firing order. In addition, combustion chamber designs and valve train layouts all dictate the basic properties of an engine. Engine installation and orientation is another important factor to be considered in a road vehicle. There are also two-stroke and rotary engine designs with their own particular characteristics, all of which are explained in this section

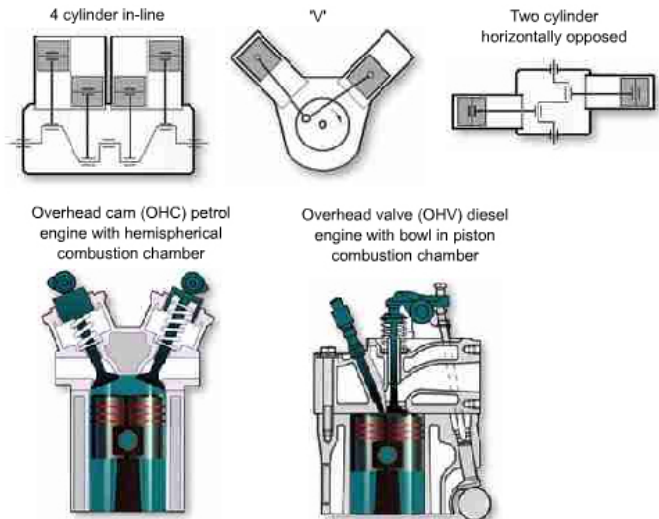

Technical Details of 4-Cylinder 4-Stroke OHC Petrol Engine

Engine □□□ This diagram shows the components of this engine type. Examine the names and detail of these components before moving on to the next screens where they are shown individually with further information on their basic function and constructional detail.

Cylinder Block and Crankcase The engine cylinders, when cast in a single housing, are known as the engine block. Generally, the engine block is manufactured from cast iron or aluminium alloy. In the latter case, cast iron or steel liners to form the cylinder bore. The engine block forms the major component of a 'short' motor.



Engine block

Cylinder Bores □□□ The cylinder bores are formed via a machining process with a boring tool to give the correct form to the cylinder within closely specified tolerances. Cast iron is a mixture of iron with a small amount of carbon (2.5% - 4.5% of the total).

Cast Iron The carbon added to the iron gives a crystalline structure that is very strong in compression. In addition, it is slightly porous and this helps to retain a film of lubricating oil working surfaces. This property makes cast iron particularly suitable for cylinder bores that can be machined directly into the casting.

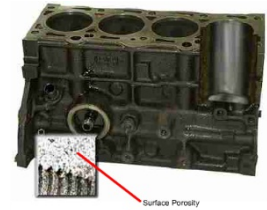

Cast iron block

Crankcase The crankcase is integrated into the cylinder block and is machined in-line to form the crankshaft main bearings. This process is known as line boring. The main bearings are split in two halves, one half locates in the block, the other in the bearing cap. The bearing caps are secured before the machining process and thus each cap is matched in position with its opposite half. It is important to note this when disassembling and reassembling the bearings. The caps are located via dowels and fastened via high-tensile steel bolts. It is important to follow manufacturer guidance if the bolts are removed and refitted, replacement of the bolts and tightening procedures must be followed if specified.



Main bearing bolts

Water Jacket Between the cylinder walls and the outside surface of the cylinder block, voids and channels are formed during the casting process, this is known as the water jacket and is used for engine cooling purposes. A sand former creates this space during casting and when the cast block has cooled, the sand is evacuated via holes in the side of the block. These holes are then sealed using core plugs.

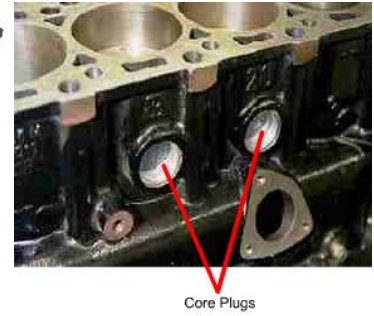

Oilways In order to supply pressurised oil to the engine moving surfaces, an oil gallery is formed along the length of the cylinder block. This has drillings to supply oil directly to the bearings in the block, crankshaft and cylinder head. Additional drillings connect the oil pump and pressure control valve to complete the oil supply system. The block is prepared, drilled and threaded in order to attach additional components like the oil sump pan and oil pump assembly.

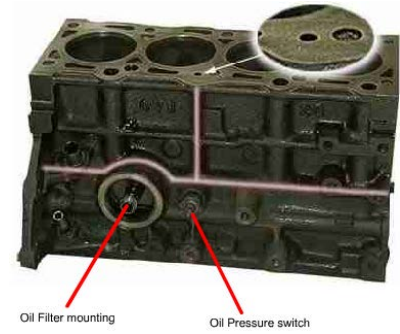

Pistons Pistons are generally manufactured from an aluminium alloy which reduces weight and increases heat dissipation. There are numerous designs to accommodate thermal expansion according to engine type and application.

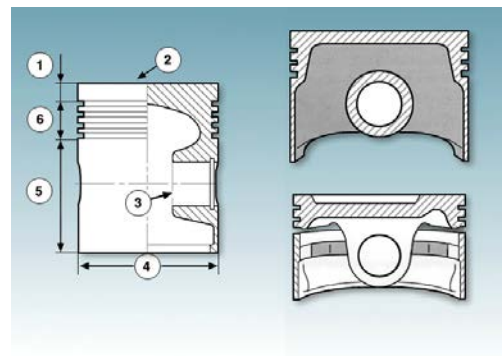

Thermal Expansion Aluminium has greater thermal expansion than cast iron used for the block and cylinder liners. This means that the piston expands more than the block as the engine temperature increases. When the engine is cold, the working tolerances are greater to allow for expansion. The piston has design features to allow for expansion and correct tolerances at running temperatures, for example, a cold piston is slightly oval and tapered inwards towards the crown.

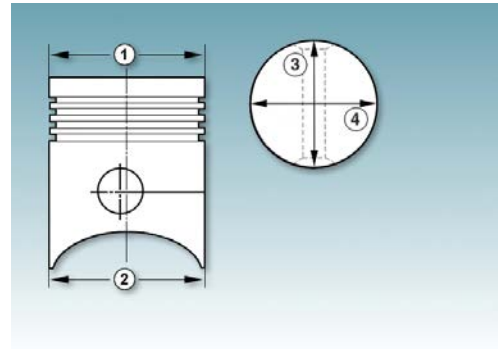

Piston Pin The piston or gudgeon pin has an offset by a small amount toward the thrust face of the cylinder bore which allows the thrust forces at the piston crown to maintain the piston against the cylinder wall. This has an effect when the engine is cold by reducing piston movement due to excessive clearance which creates a noise known as 'piston slap'. Note that pistons are marked so that they can be installed correctly and this should be carefully observed.

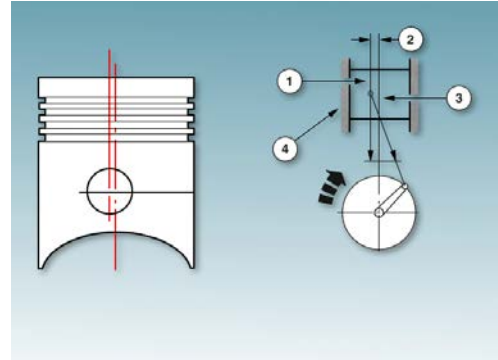

Piston and Piston Rings Around the upper portion of the piston, grooves are cut to accommodate sealing rings, known as piston rings.

Generally, there are three or four grooves and rings, the lowest is known as the oil control ring and this is used to control the amount of lubricant remaining on the cylinder bore surface to lubricate the piston. The upper rings are known as compression rings and these provide the gas tight seal, maintaining the cylinder pressures that create force to move the piston.

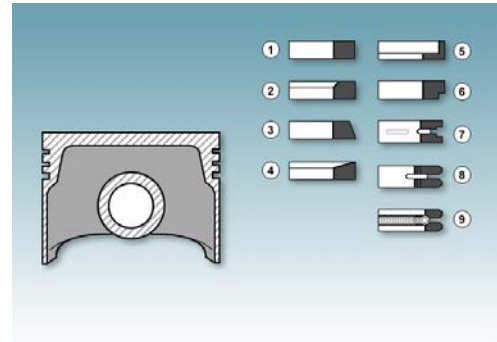

Piston Pin Bore This bore is machined into the piston to accept the piston pin, also known as gudgeon pin. The fixing mechanism of the piston pin to the piston and the connecting rod can vary. It can be an interference fit in the connecting rod, or a push fit in both the piston and connecting rod end. If the piston pin is clamped in the connecting rod, the piston pin bore is smooth. Circlips grooves are formed in the piston pin bore when a push fit piston pin is used

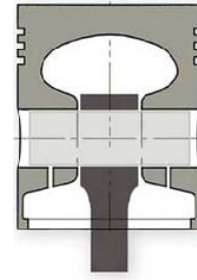

Pin bore

Cross section
of the piston

Pin in place

Piston Crown The piston crown forms part of the combustion chamber and experiences the full cylinder pressure applied by the expanding gases. Many different design are available depending on engine type, complex shapes can be formed in the piston crown to allow for valve movements and to create an effective combustion chamber space, promoting the correct charge motion for efficient combustion.



Various pistons

Piston Rings These are used to seal the combustion chamber to prevent the escape of combustion gases and loss of cylinder pressure, they known as 'compression rings'. In addition, the piston rings must control the oil film on the cylinder bore surface, these known as 'oil control rings'. Combustion pressure is allowed to act on the back of the cylinder sealing 'compression' rings to help maintain a gas tight seal of the piston assembly.



Compression and oil control rings

Compression Rings Compression rings are manufactured from cast iron, with a surface coating to promote fast bedding in. This means that the rings quickly wear in to give a gas tight seal against the cylinder pressures. It is important not to damage this coating during fitting, note that rings have different cross-sections according to their mounting position on the piston.

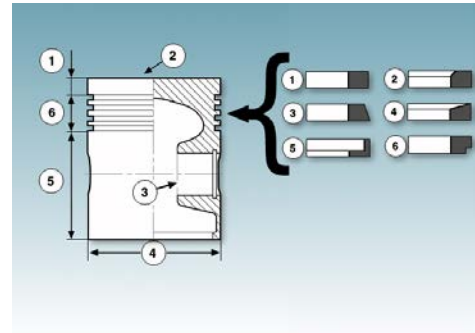

Oil Control Rings Oil control rings can be one of two designs. A multi-part ring consists of two thin alloy rings used in conjunction with an expander between them. A cast iron ring has a groove and slot arrangement to allow oil flow back to the sump via the ring and piston.

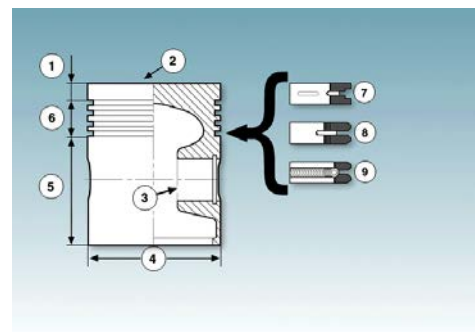

Piston Pin (Gudgeon Pin) The piston or gudgeon pin provides the mechanical link between the piston and connecting rod. The pin locates in the piston body and the 'little end' of the connecting rod. The pin can be a clearance fit into the little end bearing or bush, and hence a corresponding interference fit, or located via circlips, in the piston

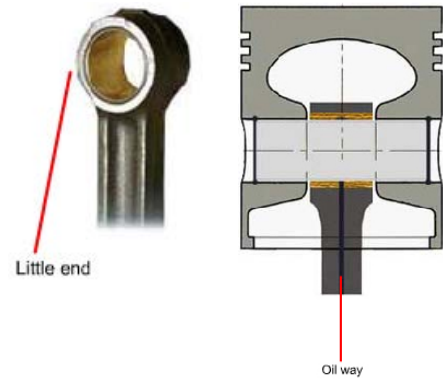

Interference Fit

An alternative is that the pin is an interference fit in the little end, or is clamped by the connecting rod. In this case, the piston pin bore is the bearing surface and there are appropriate drillings in the piston to allow for lubrication

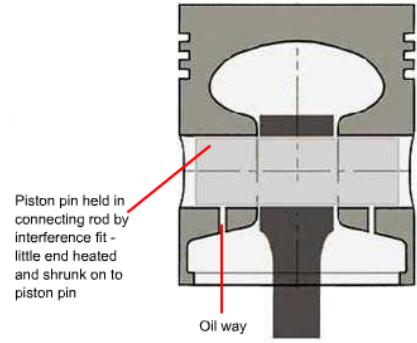

Connecting Rod The main purpose of the connecting rod is to transfer the linear force from the piston and apply it to the rotating crankshaft. It is generally manufactured from carbon steel in a process known as drop forging to form the required shape and profile.

Force transfer from piston crown to crankshaft through the connecting rod



Force transfer from crankshaft to piston crown through the connecting rod



Connecting Rod The connecting rod is designed specifically with a high resistance to bending, compressive and tensile forces via an I-section profile. The piston end, known as the little end, has an appropriate bush, bearing or clamping arrangement for the piston pin.

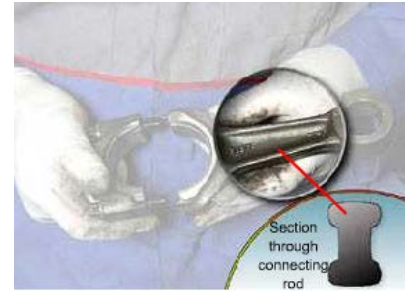

Big-End Bearing The crankshaft end of the connecting rod is known as the big end. This consists of a split bearing with a removable bearing cap. The bearing cap is attached to the connecting rod via bolts or nuts.



Matching Connecting Rod and Bearing Cap Identification Mark It is important to note that the connecting rod and bearing cap are machined as one unit, and hence, the parts are matched. Therefore, they must always be re-assembled as a pair and fitted correctly oriented.

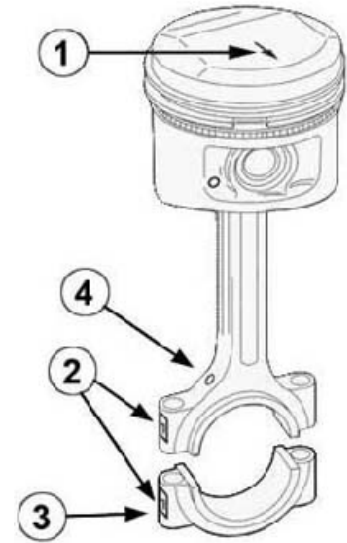

Cylinder Wall Lubrication Drillings made through the connecting rod body provide oil spray lubrication of the cylinder walls. Often, an oil supply drilling is provided through the connecting rod to spray oil onto the underside of the piston crown to provide additional cooling.

Crankshaft The crankshaft receives the linear force of the pistons, via the connecting rods, and converts this force into a rotating torque. The crankshaft is generally manufactured from cast iron or steel alloy via a forging or casting process.

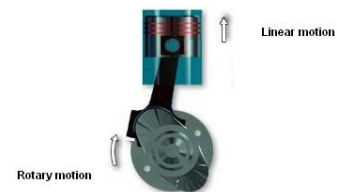

Crankshaft Generally the crankshaft of a 4 cylinder engine has 5 main bearings. At the front of the crankshaft provision is made to locate and drive the crankshaft pulley and timing gear via keyways and securing bolts. Behind this, the oil pump drive is located and then the first or front main bearing.

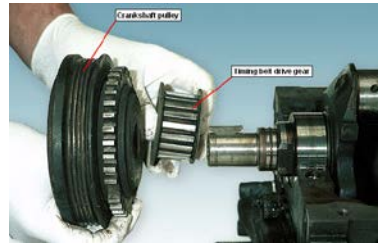

Bearing Journals The big end bearing for the first cylinder is fitted in between the crankshaft webs radiating from the main bearing journals. These webs form counter balance weights to the big end journal. Generally, one of the main bearings is fitted with an thrust washer to control axial movement of the crankshaft.



Journals

Rear Main Oil Seal At the rear of the main bearing journal, at the back of the engine, a machined face is formed on the crankshaft as a mating surface for a sealing ring. This is the main oil seal at the back of the engine. In addition, there is a machined, threaded flange surface to accommodate mounting of the flywheel. For a four cylinder engine, the big end journals are paired and set and 180°. For most four cylinder engines the firing order is 1,3,4,2.



Radial lip oil seal

Crankshaft Bearings The crankshaft bearings are split type, steel backed shells with an alloy or coated bearing surface. Correct bearing types to engine manufacturers original specification must always be fitted.

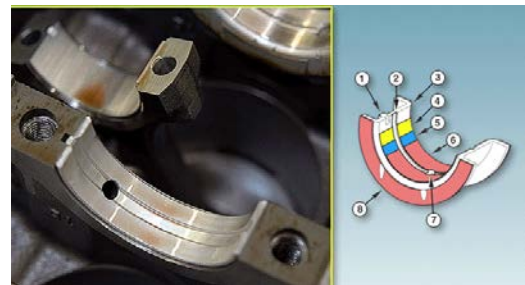

Bearing Nip Bearing shell halves, when correctly fitted and tensioned in the bearing caps, form a perfectly round profile with equidistant clearance around the bearing journal. The bearings are 'nipped' and held in position when fitted into the tightened bearing caps. The bearing shell is also fitted with a locating lug on the back that mates with a slot in the bearing locating half bores. This ensures that the bearing cannot rotate. Oil supply holes and slots are machined in the bearing surface to supply appropriate lubrication.



Bearings



Signs of 'nip'

Thrust Bearings on Crankshaft to Control Axial Movement Axial displacement of the crankshaft is controlled by thrust bearings to limit the axial movement. These are fitted at a main bearing journal either as two semi-circular rings, or as part of a main bearing shell.

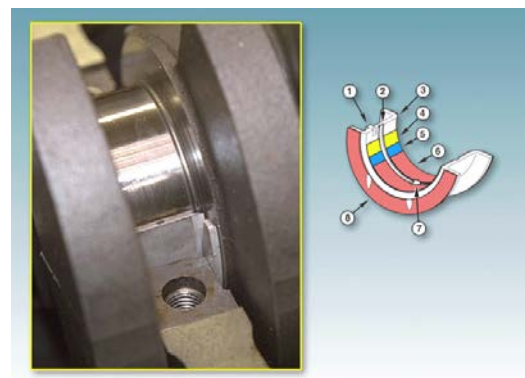

Details of the bearing

Cylinder Head Gasket This has to form a gas tight seal at the interface between the cylinder head and the cylinder bores. In addition, it must seal and separate the cooling water supply jacket and the oil supply and return drillings. Traditional head gaskets were constructed from copper and asbestos. Modern material technologies allow head gaskets to be made from composite materials which have superior sealing and heat transfer performance.



Gaskets

Head Gaskets Head gaskets must always be replaced when the cylinder head is removed and refitted. Also, when refitting a cylinder head, it is important that the manufacturer's information is sought and applied with respect to replacement of cylinder head bolts where necessary, and correct torque and tightening sequences of cylinder head bolts.

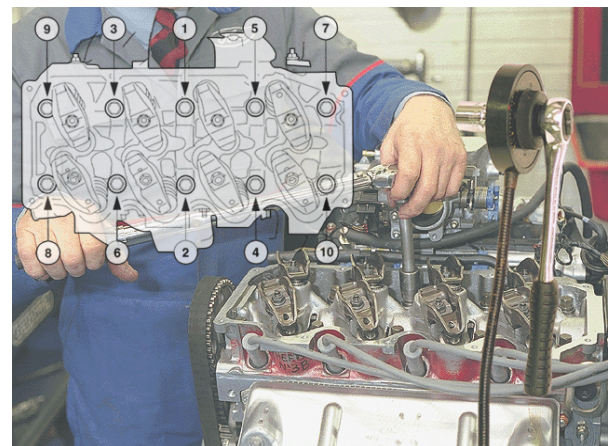

Tightening sequence

The Cylinder Head The cylinder head is cast from Aluminium alloy or cast iron. Aluminium alloy is lighter but cast iron or steel valve seats and guides must be installed in the head. Cast iron heads generally have valve seats and guides formed directly in the head material.



Aluminium head



Valve seats

Combustion Chamber the combustion chamber is formed in the cylinder head such that, on assembly, it is located directly over the cylinder bore in the engine block. There are numerous designs in use depending on engine type, optimisation parameters and application.



Inside the combustion chamber

Compound Valve Hemispherical This arrangement of combustion chamber and valves uses a hemispherical design with two valves per cylinder positioned opposite each other for cross flow movement of the intake and exhaust gases. The valves are inclined such that they sit in the curved profile of the combustion chamber space. The spark plug is mounted as close to centric as possible in the combustion chamber via an appropriate drilling. It is sealed via a compressible washer or conical sealing face.

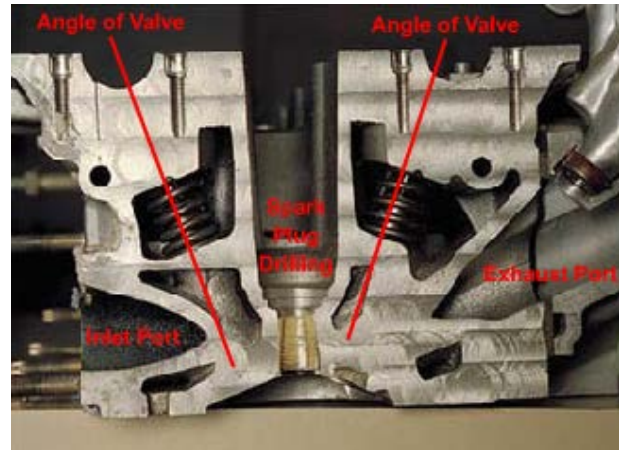

Coolant Passages The combustion chambers are surrounded by cooling water passages that connect to the water jacket in the cylinder block. The water jacket casting holes are sealed via core plugs in a similar way to the cylinder block. On the upper surface of the cylinder head, bearing journal surfaces are formed to locate the valve operating camshafts and mechanism. Oil supply drillings ensure adequate lubrication for the camshaft bearings and valve train components.

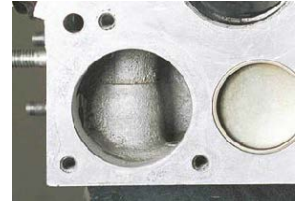

Engine coolant passages

Camshaft The camshaft is mounted in bearings formed into the cylinder head via an in-line boring process. The camshaft is forged from steel or cast iron and the bearings and cam surfaces are a smooth, machined finish. The camshaft has cam lobes for each valve and to ensure the correct sequence of valve timing, the camshaft is timed and synchronised with the crankshaft position. To achieve this, the camshaft drive gear is secured to the camshaft via a keyway. The camshaft rotates at exactly half engine speed and is marked to ensure that the correct position can be located easily when refitting.



Fitting the cam

Cam Shapes The cam lobes have a specific profile that consists of a base circle and lobe to provide the correct valve opening and closing characteristics. The cam profile is not necessary symmetric and the profile may allow progressive opening of the valve but with a sharp closing action depending on the characteristic and optimisation parameters of the engine.

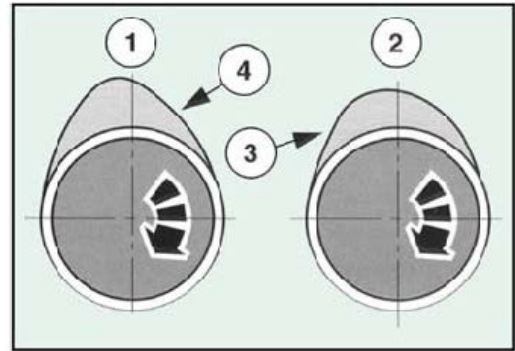

Cam profiles

Valve Operating Mechanisms There are various designs of mechanisms for following the cam profile and opening the valve. In this application, the engine uses pressed steel rockers to apply the force to open the valves, valve springs are used to close the valves

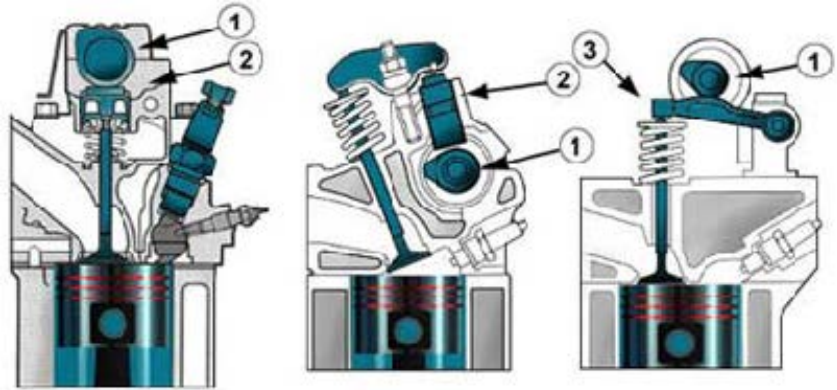

Different mechanisms

Inlet and Exhaust Valves Inlet and exhaust valves are poppet type valves with a circular sealing face recessed in the cylinder head. The valves are located via the stem and slide inside valve guides mounted in the cylinder head. Valve heads are exposed to full, combustion chamber temperatures and pressures, the temperature of the exhaust valve can be as high as 800 °C. The incoming gas charge has a cooling effect on the intake valve but generally, heat dissipation from the valves is via the stem and guides to the cylinder head. Combustion and Fuel deposits can cause problems on the valve; this can be avoided via the use of good quality fuels and oils.



Valves in position

Inlet Valve The total valve opening area is always greater for the inlet valves, this is to increase the volumetric efficiency of the engine due to the fact that the pressure difference across the inlet valve, when charging the cylinder, is much lower than the pressure difference across exhaust valve when evacuating the cylinder. Hence a larger valve is needed to reduce restrictions to gas flow during the inlet stroke

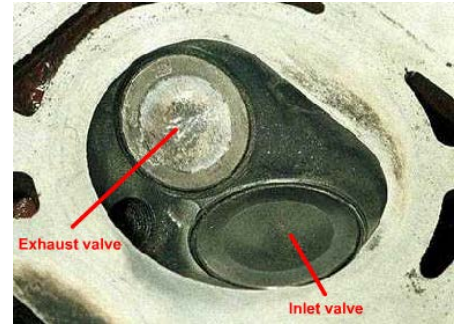

Valve Seat Angles Valves seats and the valve sealing face are cut at a slightly different angle. This is to ensure that a complete seal is made under working conditions as, when the valve is installed and at running temperatures, the valve head will deform slightly causing the sealing faces to meet correctly and seal efficiently. The angle of the sealing face is approximately 45° . The valves open via the force applied from the cam and valve gear and are held in the closed position via spring force. The springs are connected to the valve via a retainer and split collets as this allows removal and refitting. In operation, the valve head rotates and this helps maintain the sealing face.

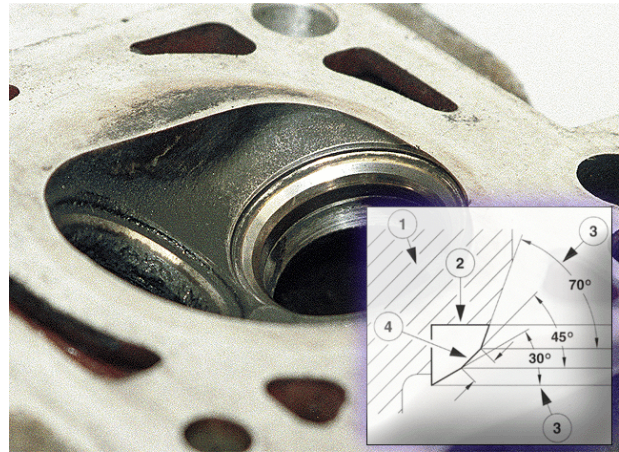

Camshaft Drive Belt (Timing Belt) For many engines, a toothed belt is used to drive the camshaft. The belt is manufactured from a durable, synthetic rubber with reinforcing fibres. The teeth moulded on the inside of the belt mate with the corresponding teeth on the crankshaft and camshaft pulley wheels.

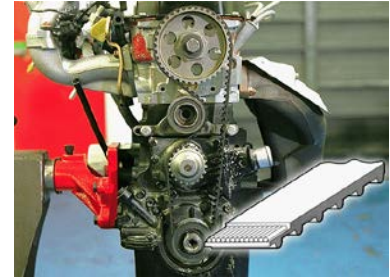

Drive belt

Belts and Pulleys The teeth formed on the belt can be trapezoidal or rounded. Note that they are not interchangeable and it is important to fit the correct type when replacing the belt.



Belt Tension Correct tension of the timing belt is imperative for maximum belt life. The belt is generally tensioned by adjustable tensioner wheels. It is important to note that manufacturer and engine specific information must be sought when making adjustments in service.

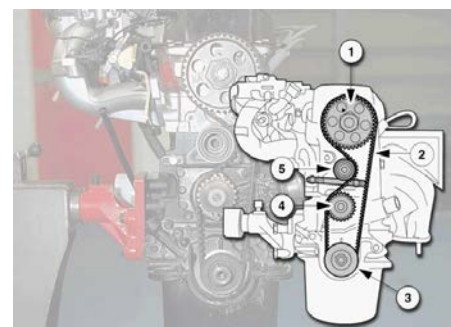

Belt drive components

Direction of Rotation

Often, the belt direction of rotation is marked on the belt itself, and it must be refitted in the same direction. If the belt is not marked, then the direction should be noted and marked before removal.

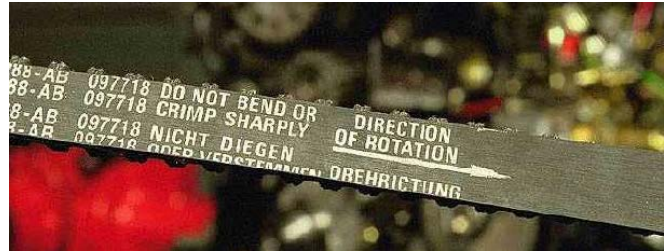

Belts are usually unidirectional

Covers, Cases and Sumps Once the main engine components have been assembled, a number of covers are fitted to enclose moving parts and retain oil. The sump is fitted on the underside and holds the oil capacity.



Final assembly stages...

Rocker Cover The cover that encloses the valve gear is known as the rocker or cam cover. Generally, it incorporates the oil filler cap and part of the engine breather system.



Crankshaft Seals At the front of the engine, there is a casing that retains the crankshaft oil seal. In addition, a cover is fitted to enclose and protect the camshaft drive belt. At the rear of the engine, another crankshaft oil seal is fitted to a casing that is bolted to the engine and located by dowels.



Sump Note that the sump contains baffles to prevent excessive oil movement or surge. This maintains a good supply of oil around the area of the oil pick up.



Auxiliary Components In addition, attached around the engine are the components and sub-systems for lubrication, cooling, ignition, fuel, air, exhaust and electrical systems. These items are covered in the respective chapters.





State an ideal material, with reasons, for:

- An engine block
- A piston
- A crankshaft
- A piston ring
- A big end bearing



Look back over the previous section and write out a list of the key bullet points here:

ROUTINE MAINTENANCE

Service Work The requirements for scheduled maintenance on the mechanical systems and components on a modern motor vehicle engine are generally limited to visual inspections for security and leakages. In addition, audible observation, for abnormal noise in operation, that could indicate impending failure. These tasks are covered in the preceding section relating to engine mechanical performance. Other items of routine preventative maintenance, such a fluid replacement, check and adjustment of components are covered in the appropriate learning program.

Service Intervals Engine with older generation valve train technology usually require check and adjustment of valve clearances at certain intervals. Engines that employ belt-type camshaft drives require condition checks and adjustment of the belt at regular intervals. In addition, complete replacement of the belt (and in some cases pulleys and tensioners) is required at higher mileage intervals. This is important as belt failure can destroy the engine.



Checking clearances

Incorrect Adjustment Slight deviation in belt tension from the manufacturers requirements can significantly reduce belt service life (10% error in belt tension reduces belt life by 90%). Over tensioning of the belt destroys the belt fabric and structure, in addition, this overloads the bearings in the tensioners and pulleys. Belt failure generally causes catastrophic engine damage as in most cases the valves will contact the pistons, severely damaging both components. It is imperative to follow manufacturers' guidelines when replacing, servicing or tensioning the belt. In addition, the work must be carried out at the correct mileage interval.

Introduction Example worksheets for typical routine maintenance procedures are included in this section. Always refer to the appropriate health and safety requirements and regulations before working on any part of the vehicle. The worksheets can be printed off and utilized to support the practical training part of this course. Note that they are for general use only and manufacturer specific service information should be available for the specific vehicle. The main points are described in the following screens.

Routine Maintenance Inspections, Lubrication and**Replacement of Parts** Routine maintenance items are

generally brief audible and visual checks to confirm correct operation, at least until the next service interval. The detail of these checks are covered in the section 'Checking system performance'. Any additional items specified in the manufacturer service schedule should be carried out according to the information supplied by the manufacturer

Correct Grade and Type of Oil If the vehicle is

subjected to extremes of temperature during summer or winter. The correct grade and type of oil must be selected accordingly to prevent engine starting and running problems. In addition, wrong oil grade can lead to excessive engine wear. Note that any additional faults found during an inspection must be reported to the customer for authority before attempting repair.

Adjust Valve Clearances Adjustment of valve clearances where required, generally OHV engines and rocker arm type OHC engines

Correct Valve Clearance Correct valve clearances are essential for efficient running of the engine. Excessive clearance will alter the valve timing of the engine (late opening, early closing), reducing the volumetric and gas exchange efficiency of the engine.

Insufficient clearance could prevent the valves from closing or seating properly, causing leakage and reduced working pressures in the cylinder.

Rapid Wear The effect of incorrect valve seating causes rapid wear and failure of the valve seat. Hot gases leaking past the exhaust valves will burn the valve seats such that, over a short time, they would require complete replacement.

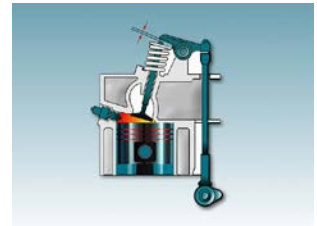

Clearance



Valves in position

Tight and Loose Valve Clearance

Correct valve clearance is also important to maintain an appropriate film of lubrication on the reciprocating valve train components. Excessive clearance allows the working faces to separate in operation and the consequential 'hammering' action of these components will destroy the protective oil film. Insufficient clearance prevents the formation of the oil film altogether, causing lack of lubrication. Both scenarios will cause excessive wear and premature failure.

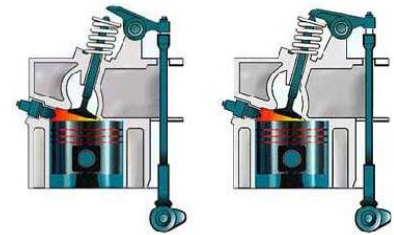

Valve clearances must be correct

Valve Clearance □□□ The characteristic 'tapping' noise from the rocker cover and associated loss of performance is a clear indicator of excessive valve clearances. Insufficient clearances causes misfire, unevenness of running and loss of performance.

Valve Clearance Dimensions **Manufacturer** specific information must be used when checking valve clearances. There are variations in clearance values for exhaust and inlet valves, in addition, the engine temperature at which the measurements should be made can be critical factor.

Checking Valve Clearance Generally, it is also important that the engine is correctly positioned in the working cycle for checking the valve clearances, often individually. This is specified by the manufacturer.

Cam Position ☐☐☐ Often, the valve clearance check is made when the follower is on the back of the cam lobe. To set this position, if it cannot be seen directly, requires positioning of the opposite valve such that it is fully open.

Adjusting Valve Clearance ☐☐☐ Remove the rocker cover and observe the sequence of the valves opening and closing as the engine is rotated by hand. Check a valve by setting the opposite valve into the fully open position, then check the clearance with a feeler gauge. If adjustment is required, release the lock nut and turn the adjuster slightly, re-check the clearance with the feeler blade which should show some resistance to being moved back-and-forth whilst in the gap, but should also be relatively free to move.

Tappet Noise Rotate the engine into the correct position to check each valve and adjust where necessary. After all the valves have been checked, repeat the procedure checking all the individual valves again note the correct values for exhaust and inlet valves have been maintained. Refit the rocker cover and run the engine, listen for tappet noise or any signs of uneven running. If these are no apparent, then the adjustment procedure has been carried out correctly.



Valves and rockers

Dial Test Indicator Under certain circumstances, wear between the rocker and valve stem prevents accurate determination of the valve clearances using a feeler blade. In this case it is possible to use a DTI (Dial Test Indicator) to measure movement of the rocker immediately above the valve clearance measurement position.



DTI in use

Replace Camshaft Toothed Drive Belt It is essential to follow the manufacturer procedure when replacing a camshaft drive or timing belt.

Timing Marks The position of the camshaft and crankshaft, relative to each other, is essential to maintain correct timing of the valve opening and closing sequences.

Manufacturers usually provide marks for the valve train pulley system to facilitate this. The engine must be aligned correctly with respect to these marks before the belt tension is released and the belt removed. The engine must be rotated in the normal direction of rotation when aligning these marks to avoid incorrect adjustment due to 'one tooth out' on the slack side of the belt.

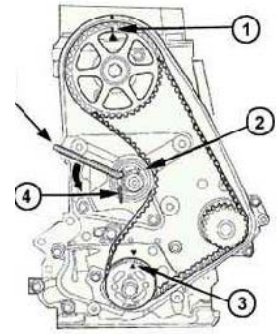

Cam belt

Cam Belt Replacement Certain engines use dowels or plugs to correctly align the camshaft pulleys. These are inserted through holes in the pulleys, into the engine block to 'lock' the pulleys in the correct position during a belt change. Note that oil leaking onto camshaft drive belts will cause failure. Lip seals are generally employed on the crankshaft and camshaft at the non-drive end of the engine where the cam belt is normally situated. At high mileages they can fail and close inspection is advisable during a cam belt change.

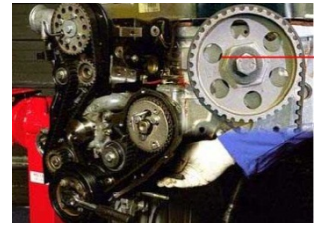

Timing belt

Drive Belts The direction of rotation of the belt must be noted and maintained when removed or replaced. The belt structure will settle into a specific rotation direction after use and reversing this can cause fracture of belt teeth and failure of the belt. Most belts are marked with the correct direction for use shown.



Direction arrow

Adjusting Belt Tension Adjusting the belt tension is a procedure specified by the manufacturer and should always be observed. This can involve the use of specific tools, for example, a belt tension gauge. Always observe the correct procedures and conditions for this task but, a general rule, is that, when correctly tensioned, the belt must not be twisted more than 90° at the mid-point of its longest run between 2 pulleys. In addition, it is important to visually inspect the belt for signs of cracking or perishing.



Tensioner



Look back over the previous section and write out a list of the key bullet points here:

ENGINES - CUSTOMER CARE

Customer Care It is worthy to note that, generally, engine mechanical problems do not occur frequently during the life of a motor vehicle. Customers can be reassured that as long as they carry out basic routine checks, are observant of their

instrumentation in the vehicle and seek advice when abnormal noises or running conditions occur, they will experience no problems with these mechanical components

Service Records Premature failure of the camshaft drive belt is a common problem that causes severe damage to the engine. This failure can be avoided if the camshaft drive belt is replaced at the correct interval, in addition, regular inspection and adjustment of the belt will generally highlight any problems so that the belt can be replaced before it fails. Customers will appreciate appropriate tracking of the requirement for this work so that they can be contacted and reminded when it is due.



Belt condition

ENGINE LUBRICATION

FRICTION AND LUBRICATION

Introduction □□ All types of vehicle engines incorporate metal parts that have to rub against each other, thus causing friction which creates stress, wear and heat, e.g., cylinders in cylinder liners. These parts require lubrication to prevent the wear, keep the surfaces clean, and help to remove the heat.

Achieving Lubrication □□ Lubrication is achieved by separating the metal surfaces with a film of oil or grease. Thus the lubricating oil in the engine has traditionally been seen to have these three functions: separation, cleaning and cooling.



Oil circulates throughout the parts of an engine under pressure produced by a mechanical pump.

Oiliness and Lubrication □□ Another important property of a lubricant is oiliness, which can be described as the ability to adhere to the surface of materials and maintain separation of the rubbing surfaces without breaking down. This type of lubrication is called boundary lubrication and occurs in all engines during starting and before the pumped oil feed is established.

Environmental Regulations Modern engines must conform to environmental regulations and modern engine oils are an important component in helping to achieve this.

Engine oil producers are responding with new blends, additives and synthetic oils to enable extended service intervals, improved wear protection, greater engine cleanliness, sludge inhibition, higher speeds and temperatures and lower oil consumption. These oils also contribute to improved performance, economy and environmental concerns about hydrocarbon emissions into the atmosphere. They are compatible with oil-seal materials so that leakage is reduced. They also have strict limits on volatility so that vapours do not escape into the atmosphere.

LUBRICATING OILS

Oil Composition □□□ Most engine oils are refined from crude oil to which are added viscosity index enhancers, reduced-friction enhancers, anti-oxygenates, sludge, lacquer and corrosion inhibitors and cleaning agents for carbon, acids and water.

Oil Types □□□ Early specifications for engine oils defined just the physical data. New oils, which have to meet environmental and engine-performance requirements, are given specification code letters to indicate the performance level.

Synthetic and Semi-Synthetic Oils Synthetic and semi-synthetic oils have improved performance for environmental or special purposes.

Multigrade Oils Multigrade oils have been developed in order to modify the viscosity index and give thin oils at low temperatures that do not become excessively thin at higher temperatures.

Viscosity Viscosity is a measure of an oil's resistance to flow, i.e., if thin, the oil will flow more easily than thicker oil. A viscosity index is the measure of a change in an oil's flow rate with a rise in temperature. The higher the viscosity index, the smaller the change in viscosity.

Viscosity and Temperature □□□Manufacturer's recommended viscosity ratings generally reflect the lowest temperature at which the vehicle is being used and may be different for summer and winter use. The viscosity rating is not an indicator of oil quality but of oil flow under particular conditions. There are some low-grade oils that carry recommendations that limit the use of the vehicle, particularly for high engine speeds, loads and long journeys. Good quality oils will be labelled with at least the API and ACEA service ratings.

 Explain what is meant by viscosity and a viscosity index.

 State the reason why lubrication is necessary.

 Look back over the previous section and write out a list of the key bullet points here:

ENGINE OIL SPECIFICATIONS

Modern engine oil specifications are based on SAE (Society of Automotive Engineers) viscosity ratings, API (American Petroleum Institute) service ratings and other properties defined by classifications laid down by organisations such as ACEA (Association des Constructeurs Européens d'Automobiles) and the earlier CCMC (Comité des Constructeurs d'Automobile du Marché Commun) for European vehicles.

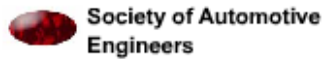

Society of Automotive Engineers



American Petroleum Institute



Association des Constructeurs Européens d'Automobiles



Comité des Constructeurs d'Automobile du Marché Commun

Common specifications (SAE is now almost universal)

API Service Ratings □□□ The API service rating classification is based on oil-performance characteristics and consists of two letters. The first letter is either 'S' for spark ignition or petrol engines, or 'C' for compression ignition or diesel engines. Originally 'S' stood for 'Service' as in Service Station and 'C' for Commercial Vehicles. The increase in diesel-engine usage in light vehicles has brought about the change of meaning. The second letter in the classification denotes the service specification, which has been updated at significant intervals and reflects the greater performance requirements of newer types of engines.

Oil-Grade Classifications The lowest grade of oil is *SC/CC*, which was suitable for engines produced during the 1960s. As the manufacturing and environmental demands have developed during recent years, improved oil performance has followed. *SD* and *SE* classifications cover the 1970s and *SF* and *SG* the 1980s. This development will continue with the introduction of newer classifications. As a general rule, a later classification can be used in place of an earlier type, but not the other way round.

Diesel-Engine Oils Diesel-engine requirements are not exactly the same as petrol engines. Separate diesel-engine oils are formulated and marketed and should be used in preference to petrol-engine oils that carry a C classification. Development of C-class oils has been slower than the S class.

Turbocharging of diesel engines is now common and these must use the appropriate grade of oil. Recent grades are CD and CE.

ACEA Classifications □□□ The ACEA classifications are divided into three groups. Group A covers petrol engines, group B covers passenger car diesel engines and Group C covers commercial vehicle diesel engines. The development of these classifications was carried out to meet the needs of European vehicles, which have different characteristics than the American engines that are used to set the API standards.

Recommended Oil Grades Most engine and vehicle manufacturers list the SAE, API and other classifications for engine oil for their vehicles. They frequently list oil-producer preferences, which give an indication of the co-operation that has been given by the oil producer in the design and development of the engine. Some manufacturers produce their own oils formulated specifically for their vehicles.

Petrol and Two-Stroke Oils □□□ Engine oils are not normally biodegradable and should not be allowed to enter the environment either as vapour or liquid. Total loss lubrication systems used on small two-stroke engines, such as those on motorbikes and outboard motors, use a 'petroil' mixture of petrol and a specially-formulated biodegradable oil. Other types of oil should not be used.

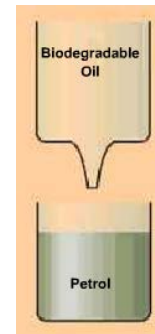

 What does SAE stand for and where is it used in relation to oils?

 Look back over the previous section and write out a list of the key bullet points here:

LUBRICATION SYSTEM OPERATION

Oil Feed □□□ A good flow of oil from a pump provides a forced feed into the shaft bearings. The large quantity of oil in the bearing generates an oil wedge that maintains separation under the severe conditions during the combustion stroke.

Forced-Feed System □□□ The forced-feed system is efficient for the removal of heat and for cleaning by carrying dirt to the filter.

Drillings and Oilways □□□ Oil is fed through the engine via drillings and oilways, and returns to the sump to carry heat away. The oil pump takes the oil from the sump and feeds it through the filter where it is cleaned.

Component Lubrication □□□ Other components are lubricated by splash from jets of oil, or by the flow of oil from the top of the engine back to the sump.

Full-Flow, Forced-Feed System □□□ Modern engines have all the oil flowing through a filter before entering the oil circuit of the engine. This circuit is known as the full-flow system. The full-flow, forced-feed system provides oil under pressure to critical components.

The majority of engines use a full-flow, forced-feed oil circulation and distribution system. These have a wet sump, and oil is pumped to all parts of the engine by a rotary, positive, displacement pump. The oil is filtered before it enters the main gallery for distribution around the engine.

Dry Sump, Dry-Sump System □□□ There are a few exceptions such as some high-performance engines where a dry sump, or dry-sump system, is used.

Forced-Feed Pump □□□ The forced feed is provided by a pump driven by the crankshaft or camshaft. A number of different pump designs are used, but all have positive displacement. These have rotating components that sweep past inlet and outlet ports and form chambers that increase in volume, carry oil and then decrease in volume in order to pump and pressurize the oil.

Oil Pressure at Low Engine Speed □□□ The oil pressure is controlled so that a sufficient supply is given at low engine speeds. This means that at higher engine speeds there would be excess pressure and oil flow, but this is relieved by a pressure-relief valve that returns the excess to the sump or to the inlet side of the oil pump.

The Engine Lubrication

System This diagram shows the components of this engine lubrication system. Look closely at the names and detail of these components before moving on to the next screens where they are shown individually, with information on function and construction detail.

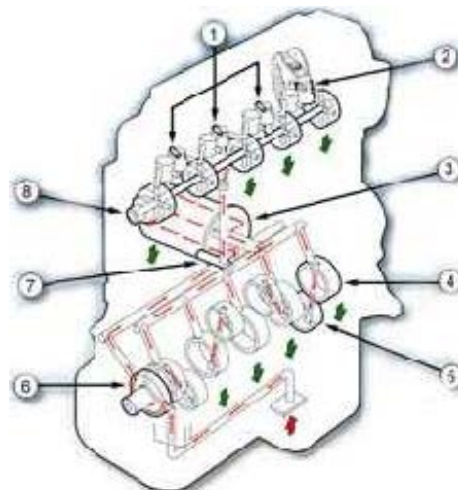

Sump □□ The sump sits below the engine and holds the main supply of engine oil. Baffles are fitted in the sump to prevent oil surges, which could cause a temporary loss of oil feed. Sumps are made from pressed steel or cast aluminium. A reinforced boss is drilled and threaded for the drain plug.

Pick-Up Pipe and Strainer □□ This connects the oil pump to the oil supply in the sump. A fine mesh strainer is fitted to the supply end of the pipe to filter large particles of carbon and dirt in the oil and prevent them from entering the pump. Pick-up pipes are connected either directly to the oil pump, or to the engine block in line with a drilling that feeds the pump. A good airtight seal is required at the connection. Two methods are used, a flange and gasket, or an 'O' ring on the pipe for sealing and a bracket and bolt for securing.



Make a simple sketch to show the main components of an engine-lubrication system.



Look back over the previous section and write out a list of the key bullet points here:

OIL PUMPS AND FILTRATION

Oil Pumps and Drive Arrangements The oil pump is the heart of the system. It pumps oil from the sump into the engine. The main types of oil pump are gear, rotor, gerotor, vane and crescent.

Gear Type The gear type uses two gears in mesh with each other. Drive is made to one gear which, in turn, drives the other. The housing has a figure of '8' internal shape, with one gear in each end. Ports are machined in the housing and align with the areas where the teeth move into, and out of, mesh.

Oil Flow in Gear-Type Oil

Pump As the teeth separate, the volume in the inlet side of the housing increases and atmospheric pressure in the sump is able to force oil into the pump. The oil is carried around inside the pump in between the teeth and the side of the housing. When the teeth move back into mesh, the volume in the outlet side of the housing is reduced, the pressure rises and this forces the oil out into the engine.

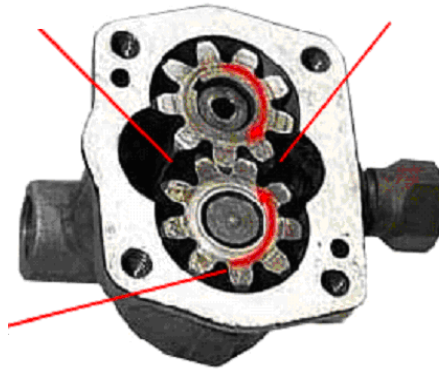

Rotor-Type Pumps □□□ The rotor-type pump uses the same principle of meshing but with an inner rotor with externally-formed lobes that mesh with corresponding internal profiles on the inside of an external rotor. The inner rotor is offset from the centre of the pump and the outer rotor is circular and concentric with the pump body. As the rotors rotate, the lobes mesh to give the outlet pressure of the oil supply, or move out of mesh for the intake of oil from the sump.

Gerotor Pump □□□ The gerotor (gear rotor pump) is a variation on the smaller rotor pump. The gerotor pump is usually fitted around, and driven by, the crankshaft. There are inner and outer rotors, with the inner rotor externally lobed and offset from the internally-lobed outer rotor. During rotation, the pumping and carrying chambers are formed by the relative positions of the lobes.

Crescent Pump The crescent pump is named after the solid block in the gear body. This pump is a variation on the gear pump, and also uses gear teeth to create the pumping chambers and to carry oil from the inlet port to the outlet port of the pump.

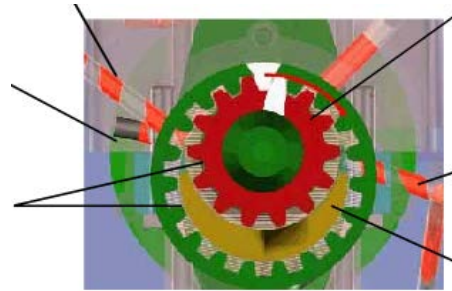

Operation of Crescent Pump

The operation of this pump is based on the meshing of the gear teeth, the positioning of the ports in the housing and alignment at each end of the crescent where the teeth move in and out of mesh. Oil is carried from the inlet port to the outlet port in the spaces between the teeth and the crescent. This pump is used for engine lubrication and for automatic transmissions.

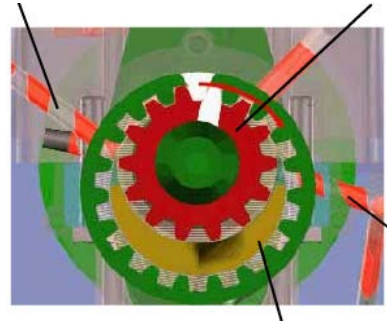

Vane-Type Pump □□□ The vane-type pump uses an eccentric rotor with vane plates set at right angles to the axis of the rotor and sitting in slots in the rotor. As the rotor rotates, the vanes sweep around inside the pump housing. The pump chambers increase in volume as the vanes move away from the housing walls, and reduce in volume as the vanes approach the walls. Oil is carried between the vanes and the pump housing from the inlet port to the outlet port.

Camshaft-Drive Arrangements Oil pumps are driven from the camshaft by gears on the camshaft and oil-pump spindle. Also, the drive gear is used often to drive the distributor for the ignition system.

Another camshaft-drive arrangement is a direct drive from the end of the shaft.

Some engines have used an auxiliary shaft to drive the pump and distributor, which has been driven from the crankshaft by a toothed belt or chain.



Direct-Drive Oil Pump □□ Some modern engines are now using the crankshaft to give a direct drive to the oil pump. These pumps are of the gerotor or crescent design, and are fitted around the front of the crankshaft. This arrangement is used on many overhead-camshaft engines because it provides a low position for the pump. Geared drives from the crankshaft are also used by some manufacturers.

Pressure-Relief Valve (or Release Valve) The oil flow and pressure at low engine speeds must be sufficient for all engine loads and, therefore, the performance of the pump is geared to low speeds. As the engine speed increases, so an excess of oil flow and pressure would occur. This would be detrimental to some engine components and, therefore, the pressure must be relieved.



Plunger and spring

Pressure-Relief Valve Functions □□□ The pressure-relief valve is a spring-loaded conical, or ball, valve that opens when the pressure in the oil exceeds the spring force acting on the valve seat. When the valve opens, a return drilling is uncovered and the excess oil flows through this to return to the sump.

Oil Filter Modern filters are canister types and consist of a micro-porous paper element in a thin steel cartridge. The paper element filters small particles of carbon and dirt that are picked up in the oil. Chemical reactions by some of the oil additives help to separate water and acids that drain into the sump. These by-products of combustion are also restricted from passing through the filter and collect on the feed side. Replacing the filter on a regular basis removes all these unwanted contaminants.



Oil Flow through the Filter Oil flow through the filter is from the outside of the element to the inside and then into the main gallery. Filters screw onto a threaded sleeve in the filter housing. Sealing is made with a rubber 'O' ring.

Replaceable Element-Type

Filter Traditionally, a replaceable element in a steel bowl was used. A similar method is being introduced on many of the latest engines. This reduces the amount of material being thrown away because oil canisters are rarely recycled. The element is similar to those in canister types, and is made from paper folded into segments to provide a round filter with a large surface area. The top and bottom of the filter are moulded to circular plates, and these provide sealing at each end so that oil is directed through the filter element from the outside to the inside and then into the main gallery.

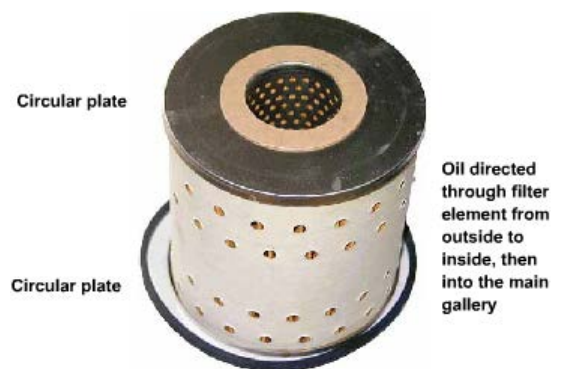

Simple filter

Replaceable Element This type of element fits inside a pressed steel or aluminium bowl, which is held in place by a through-bolt. A plate and spring are fitted into the base of the bowl. The plate seals the lower end and the spring holds the filter in place against the housing sealing face.

Filter-Housing Seal The bowl is sealed by rubber rings. Where the bowl fits onto the filter housing, the rubber seal sits inside a groove cut into the housing. Small rubber and steel washers are used to seal the through-bolt where it passes through the bowl.



This seal is very important

Oil Filter Bypass Valve After a while, the oil-filter element becomes clogged with dirt particles and the flow of oil becomes restricted. Normally, the filter is replaced before this happens, but if a blockage were to occur before replacement, the oil supply to the engine could be cut off.

Bypass-Valve Functions In order to prevent this from happening, a bypass valve is fitted into the cartridge-filter base or the filter housing. The bypass valve works on the same principle as the pressure-relief valve. A spring-loaded plunger, ball or plate sits against a seat and is lifted by oil pressure to allow the flow of oil through the engine to be maintained. The spring tension is slightly below that of the pressure-relief valve spring tension so that the normal operating pressure is retained.

Oil Flow The resistance to flow through a clean filter element is less than through the bypass valve, so normal oil flow is through the element. When the filter is blocked and the bypass valve opens, the oil is no longer being filtered and dirty oil may enter the engine. Some manufacturers fit an electric warning-lamp circuit with a switch fitted to the bypass valve.



State the purpose of a bypass valve.



Look back over the previous section and write out a list of the key bullet points here:

ROUTINE MAINTENANCE

Routine Maintenance and Customer Care

Scheduled service requirements for the engine-lubrication system overlap with the engine mechanical inspections for oil leaks and the burning of oil, which is seen as blue smoke in the exhaust gas. Oil can leak because: Gaskets, which seal the mating faces of covers, housing and the cylinder head, are worn; Oil seals on the shafts are worn; Piston/piston rings and/or valve guides are worn, or a clogged PCV system forces oil into the combustion chamber when the crankcase pressure is high.



Inspecting, Cleaning and Replacing the Filter

Inspection and cleaning, or replacing the filter and oil separators of the crankcase ventilation system, are important for oil sealing in the engine.



Components should be cleaned with care

Service Areas The main area of service work, apart from the inspections, is changing the engine oil and filter.



Filter replacement

Oil Condition Looking at the condition of the oil will indicate the existence of problems that may be developing. Black oil can be caused by either a late oil change, or could show early signs of piston blow-by. Creamy, or emulsified, oil indicates the existence of water. Report any abnormality to the owner or driver of the vehicle.



Check the oil condition

Routine Maintenance Inspections, Lubrication and

Replacement of Parts □□□ The routine inspections for the engine-lubrication system are closely related to the engine mechanical inspections. If abnormal noises are heard, it is possible that the lubrication system has failed to protect engine parts. Look closely at the oil and oil level. There is normally some loss of oil between services.

High Oil Levels If the oil level is found to be high, it is possible that the oil is being diluted by petrol or diesel draining into the sump as a result of bypassing a piston due to a leaking injector or carburettor valve.



High oil level may indicate another problem

Colour and Body of Oil The body and colour of old oil at a service interval should be inspected to look for the correct frequency of oil changes and for contamination from water, fuel or dirt particles.



Oil colour is a useful indicator of engine condition

Replacing an Oil Filter Replace the oil and the filter at the specified intervals. The service interval would be shortened for abnormal-use conditions. Refer to the manufacturer's recommendations and discuss these, as appropriate, with the owner or driver of the vehicle.



Filter replacement

Oil Leaks Check for oil leaks at all possible places. These are at all gasket joints and from the seals on all shafts that extend from inside the engine to the outside. When the engine is running, look at the exhaust for signs of blue smoke. This indicates the presence of oil being burnt during combustion.



Sump gasket



Smokin'!

Failure of the Crankcase-Ventilation System Oil will bypass the pistons if the rings are badly worn, or if the crankcase pressure is high due to a failure of the crankcase-ventilation system. Oil may be drawn also into the inlet port from worn valve stems and guides and/or valve stem oil seals. Blip the throttle during exhaust-smoke observations to see if there is any change during overrun.

Oil-Pressure Test There will be occasions when an oil-pressure test is advisable at a service interval. This is likely to be when an oil change is overdue, or when sludge is found in the engine. Carry out the test after the oil has been changed to check for possible damage or continuing blockage.

Crankcase-Ventilation Blockage A blockage in the crankcase-ventilation system will cause a failure in the operation of that system and produce a high crankcase pressure. This can cause premature failure of the oil-sealing components, so it is always recommended that the valves and restrictive orifices in the system are checked and cleaned at regular service intervals.

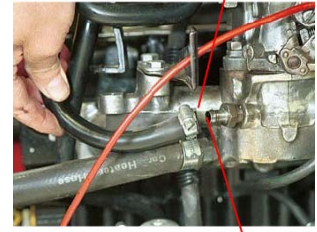

Replace Engine Oil and Filter Check the oil level and condition and run the engine to warm it up before draining the oil.

Follow the procedure for draining and refilling the engine oil and for removing and replacing the oil filter. To select the correct type and quantity of oil, refer to the engine manufacturer's workshop manual or data sheets. Always use the oils formulated for petrol or diesel engines although most engine oils show both 'S' and 'C' API ratings.

Using the Correct Filter Always check that the new filter is correct before fitting. Some canister-type filters have the filter-blockage valve in the filter body and, where this type is used, they cannot be interchanged with a canister of similar dimensions and fittings, but no valve.

Replacing 'O' Rings □□□ Always replace the 'O' rings on the canister or filter bowl. Where filter bowls are used, loosen the through-bolt to remove the filter element. Hook out and replace the 'O' rings. Fit the filter making sure that the base plate and spring are retained and, finally, twist the bowl on its seat to set the 'O' ring seal.

Replacing the Drain Plug Replace the drain plug with a new sealing washer and fill the engine with the specified quantity and quality of oil. Run the engine, checking for oil leakage as soon as the oil-warning light goes out, then stop the engine to check the oil level.



New plug washer

Overfilling the Engine Do not overfill an engine because this can cause damage by reducing the crankcase air space and this then affects the ventilation system. Damage to engine components from hydraulic action can occur if the level is very high.



State FIVE ways in which oil can be lost or used.



Look back over the previous section and write out a list of the key bullet points here:

LUBRICATION - CUSTOMER CARE

Service Schedules Most vehicle service schedules provide advice on the frequency for replacing the air-filter element and cleaning the crankcase-ventilation system. In some regions, there is a requirement for regular inspections of the exhaust emissions. Keeping records and advising customers of these requirements is a good service to provide.

Catalytic Converters Catalytic converters can be damaged when an excess of fuel is allowed to enter the converter and burn. This overheats the converter and can cause irreparable harm. Some of the incidents in which excess fuel can be passed

into the converter are driving with a misfire, ignoring an engine management-system warning light and when attempting to tow-start the engine. Advise customers of these situations and of the importance of reading the driver's instruction booklet supplied with the vehicle.



Tow-starting is not recommended

Expensive Repairs Always encourage your customers to come back to you whenever they feel that something is wrong, no matter how small. These things can often be put right before they develop into expensive repairs.

Dusty Conditions A vehicle that is only used for short journeys, or in very dusty conditions, may require the owner to adopt a modified service schedule. Most manufacturers publish recommendations for abnormal use and you can use these to organize more frequent servicing for your customer.

ENGINE COOLING

INTRODUCTION

Introduction □□□ The main function of the cooling system is to remove the heat from the engine, particularly around the cylinder walls and the combustion chambers. This should occur under all operating conditions, including the extremes of very hot weather, hard driving and high altitude.

Emissions □□□ The engine cooling system on a modern motor vehicle has to play its part in keeping exhaust emissions to a minimum. During cold start and warm-up, an engine requires a rich petrol-to-air mixture to run smoothly.

Because a cold engine produces high levels of unwanted exhaust emissions, a rapid warm-up is needed to keep emissions to a minimum. The 'normal' running engine-coolant temperature is maintained at about 90°C, which gives an engine temperature enabling clean combustion.

Emission Control The control of emissions is achieved by controlling the upper-cylinder and combustion-chamber temperatures, resulting in the efficient and clean combustion of the fuel. A further reduction in harmful exhaust emissions is achieved by keeping the warm-up time to a minimum.

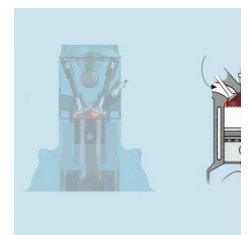

Engine cross section

Warm-Up Time □□ Warming up to the optimum temperature as quickly as possible is important, not only because it helps to reduce exhaust emissions, but also helps to prevent the formation of water particles in the combustion chamber and exhaust when the engine is cold. Any water that does not evaporate can enter the engine and contaminate the engine oil, or remain in the exhaust system and cause premature corrosive damage.

Water Jacket The water jacket is cast into the cylinder block and cylinder head. Casting sand is used to shape the inside, or core, of the casting for the water passages. The sand is removed after casting through a series of holes in the sides, ends and mating faces of the cylinder block and head.



Engine block with core plugs

Water Passages The holes in the sides and ends of the block and head are machined to provide accurate location for core plugs that complete the outside water tightness of the water jacket. The holes in the mating faces are aligned to allow coolant flow from the cylinder block to the cylinder head. These components are also machined for the fitting of the water pump and a water outlet to the radiator.



Core plugs and coolant holes

Coolant Flow The internal designs of the head and block vary to give different coolant-flow patterns. An even flow to all areas of the engine is very important. The main areas where cooling is needed are around the combustion chambers and the upper-cylinder walls.

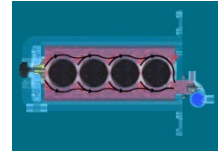

Coolant flow across the block

Cylinder Head The need for inlet ports, exhaust ports and valves makes cooling of these regions difficult. These areas are prone to cracking and other deterioration from overheating, freezing, and the use of incorrect, or old, antifreeze solutions.



Cylinder head coolant passages

Air Cooling Some older engine designs used an air-cooling system. Modern engines use water-cooling because this is capable of giving the precise engine temperature control needed for exhaust-emission regulations.



Air-cooled system



Water-cooled system

Bypass System Recent developments in coolant circulation give improved control of engine temperature. Mixing cold and hot water as it enters the engine achieves this, as opposed to the cold fill of earlier systems. Both the old and new systems are covered in this learning programme.



Ford Puma engine...

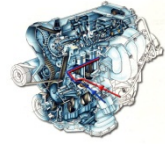

...showing coolant flow ports

Service Life □□□ Cooling-system components must have a service life that is comparable with the engine mechanical components. However, some are subject to wear and natural deterioration and need to be replaced at scheduled-service intervals.

Heating & Cooling Systems The cooling system also provides heat to the vehicle interior for the comfort and safety of the occupants. In some cases, heat and/or cooling are provided for other engine systems such as the inlet manifold. An oil cooler for automatic transmission fluid may also form part of the cooling system.

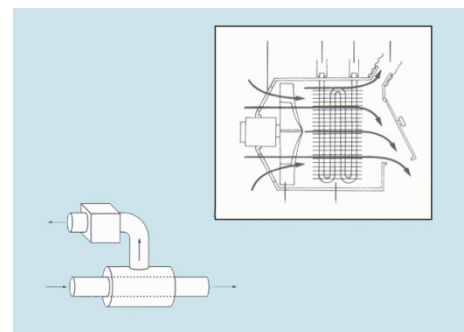

Water and air-cooled heating systems

Manifold Heating Many engines use a heated inlet manifold that has a coolant flow from the engine water jacket running continuously through it. As soon as an engine is started, some heat is produced and this rises into the inlet manifold very quickly. The heat vaporizes the fuel in the air stream into the engine. This improves atomization and fuel distribution in the new air and fuel charge.

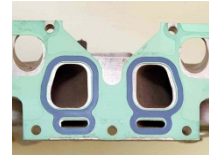

Inlet manifold



Coolant passage

Heat Exchanger Heat exchangers for cooling the engine oil and heating diesel fuel are fitted into an adapter between the oil, or diesel, filter and the filter housing. A coolant supply may also be provided to exhaust-gas turbochargers to cool the spindle and bearings.



Fuel heater

Coolant The coolant must be able to resist freezing and boiling. Contamination and corrosion of engine and cooling-system components must be kept to a minimum.



Temperature gauge fitted to test the cooling system



State the basic purpose of a cooling system and describe THREE features of an engine that need particular attention to cooling during the design process.



Look back over the previous section and write out a list of the key bullet points here:

SYSTEM REQUIREMENTS

Heat Energy □□□ Heat is a form of energy that can be sensed by a change in temperature. The engine uses chemical energy in the fuel. A combustion process converts the energy into heat and then into movement.

Energy Conversion □□□ The energy-conversion process is not very efficient and only about 30% is converted into movement energy. Of the remaining heat, up to 50% goes out of the exhaust and the rest heats the engine. Excessive heating of the engine must be controlled to prevent damage.

Expansion Components expand with heat and, at high temperatures, this expansion can cause seizure, burning of pistons and valve seats. High temperature would also produce rapid deterioration of the engine oil.

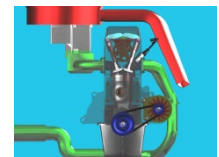

Engine components

Overheating A result of overheating is a change in the nature of the combustion process. The combustion time reduces which, in turn, leads to a rapid rise in the pressure and force acting on the piston crown, connecting rod and crankshaft. A 'pinking' sound may be heard and premature failure of these components is likely. There is also an increase in temperature to a point at which high levels of nitrogen oxides are produced and these are harmful to the environment.

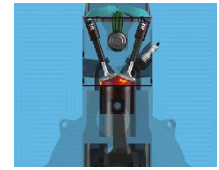

Forces acting on a piston

Cooling-System Design Cooling systems are designed to maintain engines at an optimum temperature. This allows the design of components that expand on heating to form very tight fits and running tolerances. The adjustment of ignition and fuel settings are equated to the optimum temperature required for the clean and efficient combustion of fuel.



System components

Air Cooling □□□ Air-cooled systems have the air stream passing directly over the cylinder heads and cylinders to remove heat from the source. Fins are cast into the cylinder heads and cylinders to increase the surface area of the components, thus ensuring that sufficient heat is lost.

Liquid Cooling □□□ Liquid-cooling systems use a coolant to carry heat out of the engine and dissipate the heat into the passing air stream. The liquid coolant is contained in a closed system and is made to circulate almost continuously by the impeller on the water pump. Heat is collected in the engine and dissipated from the radiator into the passing air stream.



Explain why expansion of components must be controlled.



Look back over the previous section and write out a list of the key bullet points here:

COMPONENTS AND OPERATION

Coolant □□□ The coolant is a mixture of water and antifreeze. The antifreeze is needed to prevent water expanding as it freezes. The force from that expansion would be sufficient to cause engine cylinder blocks and radiators to burst apart.

Antifreeze Sufficient antifreeze is needed for the climate in which the vehicle is operated. Modern antifreeze formulae are also designed to give year-round protection by increasing the boiling point of the coolant for hot-weather use.



Antifreeze concentrate

Heat Transfer All three forms of heat transfer are used in the cooling system:

Convection occurs in the water jacket, creating flows of internal coolant from the cylinder block to the cylinder head.

Conduction occurs through the cylinder and combustion-chamber surfaces as heat passes to the coolant.

Radiation of heat occurs from the radiator and cooling fins when heat is dissipated to the atmosphere.



Heat can be transferred...

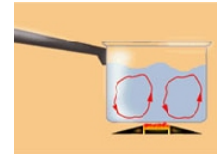

...by convection

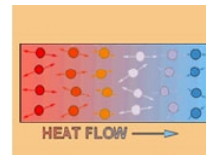

...conduction

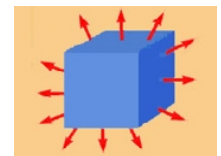

...and radiation

Rate of Heat Transfer The amount of heat transfer is dependent on four main factors:

The temperature difference between the engine and coolant;

The temperature difference between the coolant and the air stream passing through the radiator;

The surface area of the radiator tubes and fins;

The rate of flow of air and coolant through the radiator.

Thermostat Liquid-cooling systems traditionally used a thermostat in the outlet to the top hose to control engine temperature.

A thermostat is a temperature-sensing valve that opens when the coolant is hot and closes as the coolant cools down. This allows hot coolant to flow from the engine to the radiator where it cools down and returns to the engine. The cooled coolant in the engine acts on the thermostat and it closes.

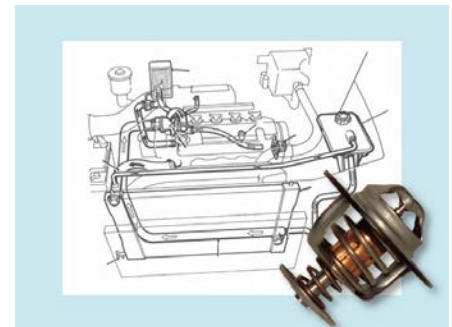

Cooling system and
Thermostat

Coolant Flow The coolant re-heats in the engine and the thermostat opens and the cycle of hot coolant flow to the radiator and cool coolant returning to the engine repeats itself. Although this system provides a reasonably effective method of engine-temperature control, it does produce a fluctuating temperature. However, a steady temperature is required for very clean and efficient combustion.

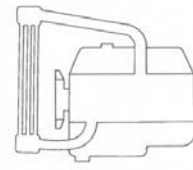

Bypass-Mixing Cooling System Modern engine design is moving towards a system with the thermostat in the radiator bypass channel. When the thermostat opens, it allows cold water from the radiator to mix with the hot-water flow in the bypass as it enters the water pump. This system provides a steady engine temperature and prevents the fluctuating-temperature cycle of the earlier system. The modern system is shown here with arrows indicating the coolant flow.

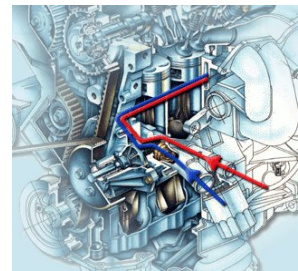

Coolant flow

Heat Distribution The heat distribution within the engine needs to be controlled. The temperature around all cylinders and combustion chambers should be identical. The heat removed by the cooling system has, therefore, to be consistent for all areas of the engine. All modern engines have a fairly rapid coolant circulation within the engine so that an even temperature distribution is achieved.

Water (Coolant) Pump The water (or coolant) pump draws the coolant through a radiator bypass channel when the engine is cold and from the radiator when the engine is hot. The impeller on the water pump drives the coolant into the engine coolant passages or water jacket. Water-jacket passages are carefully designed to direct the coolant around the cylinders and upwards over and around the combustion chambers.

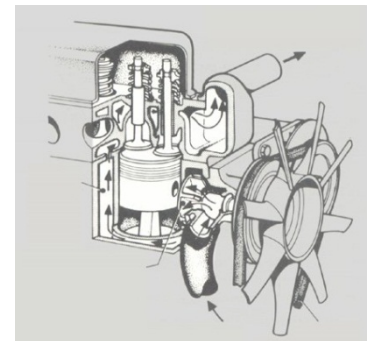

Water-pump action

Coolant Density □□□ The density of coolant falls as it heats up and, as the temperature approaches boiling point, bubbles begin to form. These bubbles can create areas in the water jacket where the coolant is at a lower density and the actual mass of coolant in those areas is reduced. The reduced mass of coolant therefore cannot effectively absorb heat efficiently in order to cool the engine.

Cavitation □□ Another problem of poor heat transfer and lowered coolant density occurs when the rapid flow of coolant into and out of restrictions in the water jacket induces a phenomenon known as 'cavitation'. This results in localized drops in pressure and density in the coolant.

Heat Distribution The two causes of localized coolant-density change - bubble formation and cavitation - can seriously affect the performance of the cooling system. This is because an even heat distribution around the cylinders and combustion chambers is not maintained.

Pressurized Cooling Systems □□ To overcome these problems, all liquid cooling systems are pressurized. When hot, most modern systems have an operating pressure equivalent to about one atmosphere (1 bar, or 100 kPa).

Expansion The pressure is obtained by restricting the loss of air above the coolant in a radiator header tank or an expansion tank. As coolant heats up it expands. If the air above the coolant has less space to occupy, and it cannot immediately escape, it increases in pressure.



Expansion tank

Radiator Pressure Cap A pressure-sensing valve in the radiator cap allows this higher pressure to escape but retains the operating pressure.

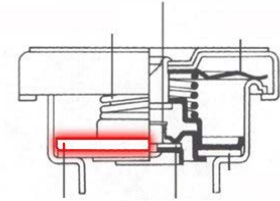

Radiator pressure-cap details

Pressure-Cap Vacuum Valve As the engine cools down, the coolant contracts and the pressure drops. A vacuum valve in the pressure cap allows air to return to the system. This prevents depressurization below atmospheric pressure and also the risk of the inward collapse of components. An early sign of the failure of this valve to open is a top hose that has collapsed.

Increased Coolant Density □□□ The pressure in the system acts on the coolant to increase the density, which would otherwise have fallen without the increase in pressure. This helps to reduce the risk of cavitation and to increase the boiling point of the coolant under pressure. The advantages are a more efficient cooling system with a higher safe operating temperature. It can also be used at high altitudes without the need for modification.

Summary A cooling system is needed to prevent engine damage caused by overheating. It also helps to reduce emissions by shortening the engine warm-up time. Heat is used from the cooling system to operate the heater.



Name and state the purpose of FIVE main cooling system components.



Look back over the previous section and write out a list of the key bullet points here:

COOLING & HEATING

Cooling System In a liquid-cooling system, the coolant carries heat from the engine to the radiator. Airflow through the radiator dissipates the heat into the atmosphere. Air is forced through the radiator by the forward movement of the vehicle, or is assisted by a fan fitted behind the radiator.

Cooling Fan The fan can be driven by an electric motor, or by a belt from the crankshaft. Traditional engines had the fan mounted on the front of the water pump with a "V" belt driving the fan and pump.

Fan Design A number of energy-saving fan designs have been used such as variable-pitch and viscous-hub types. Vehicles that are regularly used for carrying loads, or for towing, can be fitted with secondary fans to improve cooling efficiency and prevent engine overheating.



Twin electric fans

In-Car Heating Some of the surplus heat from the cooling system is used for in-car heating. Pipes and hoses from the water jacket carry hot coolant to a heater radiator or matrix fitted into the heater housing.

Heater Controls Two methods of heat control are used. One uses a water valve to control coolant flow through the heater. The other, which has a continuous coolant flow, uses control flaps to mix hot and cold air in the heater housing.

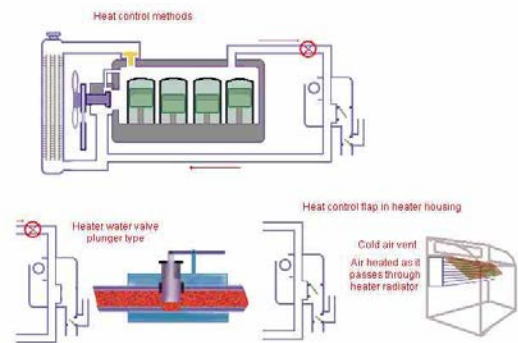

Heat control methods

Fresh-Air Ducts Ducts into and out of the heater direct air to the screen, side screens and passenger compartment. This is for demisting, defrosting and warming the passenger compartment. Control flaps in the heater direct the airflow to the ducts. Fresh-air vents in the fascia can direct either hot or cold air into the vehicle interior.



Heater air control flaps



Fresh air fascia vents

Component Design Some of the cooling system and heater components have different designs. Many of these have been developed to improve the efficiency of the system, or because of changes in vehicle design.



Describe the operation of a water-cooled system car heater AND how the temperature is controlled.



Look back over the previous section and write out a list of the key bullet points here:

ANTIFREEZE

Coolant The coolant is a mixture of water, antifreeze and inhibitors. The antifreeze is usually ethylene glycol, which needs inhibitors to prevent corrosion and foaming. These inhibitors have a life span of about two years, which means that the coolant should be changed at biennial intervals. Selection of the correct coolant mixture must be made to meet the manufacturer's specifications. Aluminium-alloy engines are more prone to corrosion than cast-iron engines.

Antifreeze Antifreeze is mixed to a specified ratio with water. Many manufacturers specify a 50/50 mixture of water and antifreeze, which allows higher engine temperatures before the coolant boils and prevents freezing.

Ethylene Glycol An ethylene glycol antifreeze solution has an added advantage. It forms a semi-solid wax solution prior to solidification and this enables any expanding ice crystals to move within the water passages.

Frost Protection A 50/50 coolant mixture will increase the boiling point to 106°C (223°F) and provide protection down to -34°C (-30°F). For colder temperatures down to -65°C (-90°F), a maximum mixture of 65% ethylene glycol can be used. Higher concentrations begin to freeze at higher temperatures and therefore no more than 65% ethylene glycol should be used.

Hard-Water Areas Many areas have 'hard' water that contains calcium or chalk. This separates from the water when it is heated. Deposits can form inside the water jacket or radiator where they can block small water passages. Frequent topping up with mains water in hard-water areas should be avoided. In these areas, it may be recommended to use distilled water, or water from outside the area.

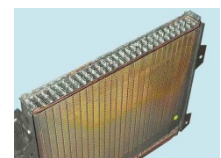

Radiator
water
passages



State TWO purposes of antifreeze.



State how the percentage of antifreeze in a vehicle is determined.



Look back over the previous section and write out a list of the key bullet points here:

ROUTINE MAINTENANCE

Servicing Scheduled service requirements for the engine cooling system consist of checks on its performance and operation. All of the quick checks described in the Checking System Performance section should be completed. Obtain data from the vehicle manufacturer's service schedules for the work to be carried out at any particular mileage or time interval.

Routine Replacement The main cooling-system items for routine replacement are the antifreeze and coolant. Rubber components such as hoses and drive belts are replaced if they begin to show signs of deterioration. A preventative maintenance programme would include replacement of hoses and drive belts at, say, three or four yearly intervals. Report any faults found during service operations to the owner or driver of the vehicle.



Worksheet Routine maintenance inspections,

lubrication and replacement of parts.

The routine maintenance items are mainly quick checks to ensure that the system is operating correctly, and is likely to do so until the next scheduled service. The detail of the checks is covered in the *Checking System Performance* section. Any additional items that are specified in the service schedule should be carried out in accordance with the manufacturer's instructions.

Pollen Filters On vehicles fitted with pollen filters, the paper element should be replaced at the specified mileage/kilometres, or more frequently in very dusty conditions. Replacing the coolant with a new water and antifreeze solution is covered by the next worksheet.



Use good quality filters



Worksheet Drain and top up coolant for

winter/all-year-round usage.

There are two types of service schedule. Most types are based on mileage and time but some older schedules were based on seasonal requirements.

The reasons for seasonal maintenance are still valid and can be used on top of mileage and time service schedules.

Seasonal Checks Cooling-system maintenance should match the season. In the summer when hot weather is expected, it is important that the system is working efficiently and that checks for leakage and coolant and airflow through the radiator are carried out. Any faults found should be reported to the customer for permission to fit replacement parts.



Radiator being drained

Winter Conditions During winter months, the risk from coolant freezing is high. Adequate antifreeze strength is necessary to prevent damage to the engine and radiator because water expands during freezing.

Draining Coolant Drain the coolant into a clean drain tray and transfer to a clean can or tank for disposal at an authorized site. The container should be marked to show the contents as antifreeze - ethylene glycol. Never use food containers for this purpose. Follow the vehicle manufacturer's instructions for the method of draining.



Coolant being drained

Antifreeze Observe the manufacturer's recommendation for antifreeze type and quantity. Antifreeze solutions for year-round use have additives and inhibitors to make them suitable for this type of application.



Check antifreeze regularly

Filling the Cooling System Some engines will fill without incurring the problem of air bubbles forming in the water jacket or heater. However, if problems are encountered, bleed the system in accordance with the vehicle manufacturer's instructions. Where bleed valves are fitted, open these before filling and close them when coolant flows freely. When an engine has to be run to force coolant through the heater, take care to keep clear of rotating components and hot coolant.



Bleed valves
in cooling
system

Safety First Show the customers what to look for and explain how important it is for safety reasons that they do not remove the pressure cap until the engine has cooled down.

Overheating and Freezing For drivers, there are two main concerns related to the cooling system. These are overheating and freezing. Overheating is more common during the summer months and frequently occurs on long journeys and in traffic queues. A reminder during the Spring for the need to check the cooling system for coolant level, water pump drive-belt condition and for hose condition is appreciated by customers.

Pre-Winter Checks During the autumn, remind them of the need for a pre-winter check of the coolant antifreeze content. Most manufacturers now recommend a 50% ethylene-glycol solution. Explain why it important that this coolant mixture should be used for topping up that system.

Frozen Coolant If a customer reports a frozen cooling system, advise them to make sure that the engine is gently warmed until the coolant thaws. They must then have the antifreeze content checked and topped up as soon as possible. If necessary, explain how the coolant in the engine can be liquid but, if the radiator is frozen, the engine will still overheat. This is because the coolant cannot circulate.

Coolant Leaks Coolant leaks can wreck engines. A driver should watch the temperature gauge and make the daily, or weekly, checks needed for early detection of cooling-system problems and particularly before any long journeys. Advise the customer, if necessary, that ethylene glycol is a skin irritant and can damage or discolour some types of paintwork.

Customer Care All faults should be reported to the vehicle owner or driver, together with recommendations for further diagnostic investigations or repair work. Always ensure that the vehicle is clean before returning it to the customer.

Summary Remember, regular checks of the cooling system will keep the vehicle reliable - and the customer happy!



Look back over the previous section and write out a list of the key bullet points here:

AIR SUPPLY, EXHAUST AND EMISSIONS

AIR POLLUTION FROM MOTOR VEHICLES

Introduction □□□ Atmospheric pollution has become a serious problem to the health of people and to the environment. Many urban areas are now heavily polluted, with people suffering medically from the effects of vehicle exhaust pollution.

Fossil Fuels There have been many changes in climatic conditions in the world. Many of these have occurred over a long period and animals and plants have adapted to the changes naturally. However, the rapid burning of fossil fuels during this century has increased carbon-dioxide levels in the atmosphere.

Vehicle designs are concentrating on weight reduction, aerodynamics, reducing rolling resistance, and on fuel-efficient engines. Alternative fuel sources to reduce fossil-fuel usage and to conserve the world's stock of these fuels have also been developed.

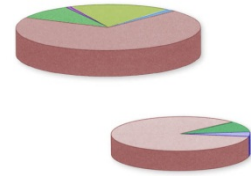

Composition of exhaust



Ford Prodigy - Hybrid vehicle

Carbon Dioxide ☐☐☐ Carbon dioxide allows the sun's heat in, but reduces the ability of the heat to radiate outward, causing the Earth to warm up. Many studies of the warming process indicate that the rate of Earth warming is increasing too quickly and preventing animals and plants from adapting. During the history of the Earth, rapid changes like this have caused the extinction of some species of animals and plants.

Weather Patterns As a result of warming, weather patterns change. Arid areas become wet and wet areas become dry. Drought conditions become common in heavily populated areas and other areas suffer severe flooding. Because the distribution of populations and agricultural production are linked, they end up in the wrong climatic conditions. The consequences are severe shortages of water and poor agricultural production.

Ozone Layer A layer of ozone in the stratosphere filters harmful radiation. Ozone, or trioxygen (O_3), is a form of oxygen with 3 oxygen atoms. Vehicle emissions and other industrial chemicals, such as the CFCs used in refrigeration, air-conditioning and aerosols, rise up into the stratosphere and chemically combine with the ozone. This causes it to break down into less beneficial substances. The deterioration of the ozone layer allows an increase in the harmful radiation that reaches the Earth's surface, which can cause skin and other cancers.

Environmental Regulations □□□ Environmental regulations are now in place to find safer alternatives, or to reduce the production and use of the most harmful pollutants. Other regulations and agreements are seeking to reduce the production of carbon dioxide by improving the efficiency of fossil-fuel burners. For retaining the energy produced, improvements will also be introduced, such as the use of insulation and other methods.

Lead □□□ Lead has, until recently, been used as an additive in petrol in order to slow down the combustion process. This was to eliminate knocking or pinking in the engine. It made engines more efficient but the lead did not burn and was, instead, passed into the atmosphere from the exhaust and produced airborne concentrations that were capable of causing many physical disabilities, including brain damage.

For this reason, lead additives are no longer used and modern engines are now designed to run on lead-free fuel. There may be a small portion of naturally occurring lead in some fuels but, because this is very low, the description 'lead-free' is more precisely a statement that lead additives have not been used.

Sulphur □□□ Another naturally occurring substance in fossil fuels, particularly diesel, is sulphur. This does not burn but, during combustion, chemically reacts with oxygen in the air to form sulphur dioxide (SO_2). This passes from the engine exhaust into the atmosphere where it combines with water to form sulphuric acid (H_2SO_4) and falls back to earth as acid rain, which destroys trees, plants, other vegetation and aquatic life in streams, rivers and lakes. Fuel suppliers remove, or reduce, the amount of sulphur during the refining process.

Nitrogen Oxides □□□ Air consists of approximately 80% nitrogen which, under normal circumstances, is an inert gas. An inert substance is one that has very little chemical reaction and does not burn, or mix easily, with other chemicals. Nitrogen, however, will mix with oxygen in high temperatures to form nitrogen oxides (NO_x). These combine in exceptional geographical and meteorological conditions to form smog, acids and increases in low-level ozone. This serves to make a very unpleasant atmosphere in which to live. Many respiratory and asthmatic fatalities occur under these conditions.



Look back over the previous section and write out a list of the key bullet points here:

ENGINE COMBUSTION

Combustion □□□ The combustion of fuel inside the engine is a chemical process that combines the carbon and hydrogen in the fuel with oxygen in order to release energy. Slightly less than 20% of air is made up from oxygen. Complete combustion produces carbon dioxide (CO_2) and water (H_2O). Neither of these is directly harmful. Both are naturally occurring substances in large concentrations in the atmosphere. However, carbon-dioxide concentrations are increasing and contributing to the greenhouse effect.

Incomplete Combustion □□□ Incomplete combustion leaves some of the carbon and oxygen not fully combined. The product of this is carbon monoxide (CO), which is toxic. Small quantities of carbon monoxide molecules are dangerous because they attach themselves to red blood cells. This reduces the oxygen that the cells normally carry around the body. The result is oxygen deprivation, brain damage and fatality.

Unburnt Fuel □□□ Another product of incomplete combustion is particles of fuel that have not been burnt. These are carried, with the exhaust gases, into the atmosphere and are called unburnt hydrocarbons (HC). Very small amounts of hydrocarbons in the atmosphere can cause respiratory problems.

Engine Oil □□ Engine oil drawn into the combustion chamber, either from the inlet valve stem, or by bypassing the pistons, can also be sources of hydrocarbon pollution. Oil vapours form in the engine crankcase and can escape into the atmosphere. A positive crankcase ventilation system is now used to draw the vapours into the engine so that they are burnt to form water and carbon dioxide.

Evaporative Emissions Previously, vapour in the tank was directly vented to the atmosphere. This is no longer the case, but the fuel tank must still be vented to the atmosphere to allow air to flow into the tank as fuel is used. A charcoal filter is now used to prevent the loss of fuel vapour and for the expansion of the fuel when the weather is hot. The fuel vapour in the charcoal canister is drawn into the engine and burnt.

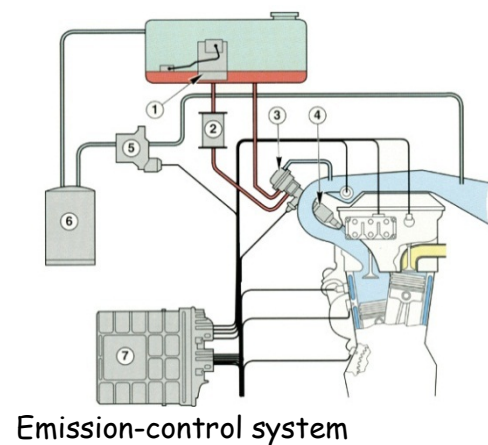

Air-Fuel Ratio □□□ Good fuel economy is obtained with a lean air-to-fuel mixture. However, this mixture produces higher combustion temperatures and greater risks of nitrogen oxides being formed. In order to prevent, or reduce to a minimum, the formation of nitrogen oxides, the combustion temperature has to be kept as cool as possible and the amount of oxygen limited to match the quantity of fuel delivered.

Exhaust Gas □□□ In order to reduce the amount of oxygen in the air charge, a gas that is low in oxygen can be introduced. This maintains the total air-charge mass to give good compression pressures and efficient operation of the engine. The available gas is the exhaust gas that has already used up its oxygen content during combustion. The addition of a regulated charge of exhaust gas reduces the oxygen content of the new charge to suit the amount of fuel delivered. This in turn reduces the combustion temperature and limits the formation of nitrogen oxides. The catalytic conversion of any remaining harmful gases can give a clean exhaust gas.



Explain what is meant by 'incomplete combustion'.



Look back over the previous section and write out a list of the key bullet points here:

SYSTEMS DEVELOPMENT FOR ENVIRONMENTAL PROTECTION

Reducing Pollution Vehicle engine and component manufacturers have put a great deal of effort into reducing pollution. Lead is no longer needed in petrol because other less-damaging substitutes have been found. The changes in the fuel have necessitated the use of hardened valves and valve seats and changes to the ignition timing and fuel-delivery systems.



Valves

Air-Intake Systems Air-intake systems have been developed from a simple ducting to a complex air-flow design adapting to the changing speed and load conditions of the engine. Filtration is also an important aspect.



Air filter

Electronic Control Electronic control of the combustion process has achieved reductions in CO, NO_x and HC emissions. Exhaust gases are monitored in an electronic engine control module from signals sent from a lambda, or oxygen, sensor in the exhaust. This then allows fuel and air supplies to be accurately merged for near-perfect combustion.



Lambda sensor

Pollutant Control The remaining pollutants in the exhaust gases, which cannot be controlled by the electronic systems, can be converted into less-harmful substances. This is achieved by using air injection into the exhaust and/or a catalytic converter.



Air injection



Catalytic converter

Atomization Developments to improve the atomization and the mixing of the fuel in the incoming air stream include heating the inlet manifold, or heating the air as it enters the inlet manifold. This can be achieved with a heater element below the carburettor, or by preheating the air by ducting the air supply over the exhaust manifold.



Air temperature control valve

Oil and Fuel Vapours Oil and fuel vapours are trapped and routed through the engine to be burnt. Positive crankcase ventilation and a charcoal filter in an evaporative canister are used for this purpose. Nitrogen-oxide formation is reduced with exhaust-gas recirculation (EGR).



EVAP canister

Supercharging and Turbocharging

Engine performance has been increased, without an increase in weight, by the use of supercharging and turbocharging. Other emission-control devices that correct the ignition timing and fuel delivery are covered in the appropriate learning programmes. These devices improve the performance of those systems, as well as reduce harmful exhaust emissions.



Turbocharger



State FOUR benefits of electronic control.



Explain why pollution should be controlled.



Look back over the previous section and write out a list of the key bullet points here:

AIR-SUPPLY SYSTEM AND INTAKE AIR TEMPERATURE CONTROL

Introduction The air-supply system has to provide clean air in sufficient quantity to the engine. Also, it must supply equal quantities of air to each cylinder. This will assist fuel vaporization and an even mixture distribution. Creating a swirl in the airflow as it enters the cylinders is also desirable. A system of warm air for cold starts, followed by temperature-controlled air for normal running, is essential. Finally, the system must silence the airflow and provide a flame trap in the event of fire in the inlet manifold.

System Components The air-supply systems for most vehicles are similar. They consist of an air-intake duct, an air-temperature control mechanism, an air-cleaner housing and filter, an inlet manifold and inlet ports. A position for an exhaust-gas recirculation system may also be included. For multi-point, or port, fuel-injection engines, the system will also include a throttle-body housing and an airflow meter.



Throttle body



Airflow meter

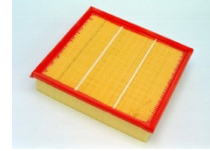

Air filter



Ducting

Clean Air Clean air is required in the engine to prevent particles of dust and grit from damaging, or blocking, engine and fuel-supply components. Air is filtered through an element in the air cleaner. Most air-cleaner elements are made from micro-porous paper, which allows a good flow of air but traps airborne dust. Other elements have included oiled wire gauze and foam rubber. The air-cleaner housing and the filter elements are cleaned, or replaced, at scheduled service intervals.



Air filter

Paper Elements Paper elements are folded to provide a large surface area and long service life. The element can be wrapped to form a circular element if required. The outside edges are sealed with an integral, or separate, rubber sealing ring.



Circular-type air filter

Air-Cleaner Housings Air-cleaner housings have internal ducting to distribute the air over the full surface of the filter. The airflow in some filter housings is made to swirl so that airborne dirt is thrown out and falls into a dust trap in the base of the filter. The airflow into flat filters is from the underside so that dirt falls out from below, rather than into the top of, the filter.



Filter in its housing

Inlet Manifolds The inlet manifolds on modern engines are usually of the same length and diameter to enable all cylinders to be supplied with the same volume and airflow characteristics.



Modern inlet manifold



Old inlet manifold

Early engines, with manifolds using pipes of differing lengths, often produced slightly different combustion patterns in each of the cylinders.

Throttle Plate □□□ At the entrance to the inlet manifold is the throttle plate controlling the flow and quantity of air entering the engine. Diesel engines do not use a throttle plate unless a vacuum is required for the control, or operation, of other systems.

Intake-Air Heating For Cold Engines Mixture composition occurs in the inlet manifolds of carburettor and monopoint fuel-injection engines. These manifolds are heated to aid the atomization and distribution of the fuel in the air charge. This is particularly important when the engine and the air supply are cold. Inlet manifolds were made from aluminium, which readily conducts heat and warms evenly and quickly. However, thermoplastic is now being used more often.



Plastic inlet manifold

Manifold Heating On older types of engine with the inlet manifold positioned over the exhaust manifold, an exchange of heat was provided by connecting the two manifolds together. This design is not suitable for cross-flow and "V" engines. One method of inlet-manifold heating on these engines uses the engine-cooling system. Water passages in the manifold are connected to the water jacket so that coolant flows as soon as the engine is started.



Water-heated inlet manifold

Electrical Heating Another method, which does not use the cooling system, has an electric heater element under the centre of the manifold operating when the engine is started from cold. A temperature-sensing switch in the engine coolant cuts off the electrical supply when the engine temperature rises.

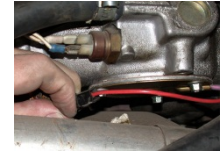

Electric manifold heater

Heated-Air Supply On some engines, the incoming air supply is heated. Two designs have been used for this. One heats the air below the carburettor, and the other before it enters the air cleaner. The older fuel-evaporative system, used on some American-vehicle engine designs, had an electric heater element below the carburettor to heat the air flowing into the manifold. The heater element was supplied with an electric current through a relay and controlled by an engine temperature-sensing switch.



Heated air improves vaporization

Air-Temperature Control Heating the air entering the inlet duct assists in atomization and fuel distribution in the air charge. To warm the air, it is passed over the exhaust manifold before being drawn into the air duct. This is only necessary when the air is cold. When the engine temperature increases, the air density, and therefore mass, would be reduced if heating of the air were continued. At an engine temperature of about 50°C, the full air supply is drawn from a cold position in the engine compartment, or from the front of the vehicle. Between a cold engine and 50°C, progressive mixing occurs.



Pick-up for hot air on an exhaust manifold

Flap Control □□□ The ducting of warm, or cool, air is controlled by a flap in the air-cleaner intake. This provides either a normal airflow, or one from over the exhaust manifold. Two designs of thermostatically-controlled air-cleaner operation are used. One type uses a vacuum motor and bimetallic vacuum valve and the other uses a wax-pellet actuator.

Vacuum System □□□ The layout of the vacuum system is shown here. The bimetallic valve responds to the temperature of the incoming air stream and opens or closes the vacuum supply from the inlet manifold to the vacuum motor. The motor reacts to the vacuum supply to move the flap and mix warm and cool air.

Wax-Pellet Actuator The wax-pellet actuator is set in the warm-air-supply duct and, when cold, holds the flap across the cool-air duct. As the wax pellet is heated up by the warmed air, it expands and forces out the insert pin, or piston. The pin is connected to a lever which pulls the flap open to allow in a cool airflow. The lever and flap are held by a calibrated return spring and actuated by the force of the expanding wax pellet.



Wax pellet warm-air control

Air Intake for Multi-Point Fuel

Injection The air supply components for multi-point fuel-injection engines have additional items for the control and measurement of the air supply. Sensors for the fuel-injection electronic control unit are included in the air-supply system. An actuator for controlling the engine fast idle speed is also included. The fuel injectors are fitted into the inlet ports, or in a special housing between the inlet manifold and the inlet ports.

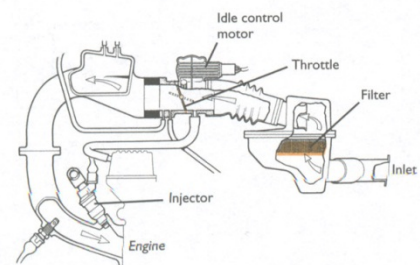

Air-supply system

Inlet Manifolds □□□ The air supply to each cylinder passes through equal-length and diameter tubes of the inlet manifolds. Feeding the manifold tubes is a plenum chamber, which holds a large volume of air so that each intake tube receives an equal air supply. The airflow is made to swirl in the intake tubes, and careful design of the shape and direction of the tubes is required to make this happen. Another factor affecting the swirl is the volume and speed of the airflow.

Variable-Length Inlet Manifolds

Many engines have a dual-intake system that responds to low and high engine speeds. These systems have valves that open at higher engine speeds to balance the pressure in the two intake manifolds, or open to enable a secondary air supply to provide an adequate airflow for the higher engine speed. These systems have been developed to meet the changing airflow and swirl characteristics occurring with increases in air mass and speed.

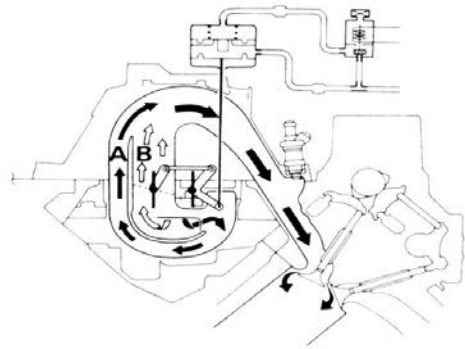

Inlet tracts change at different speeds



Explain why intake air temperature is controlled.



Look back over the previous section and write out a list of the key bullet points here:

EXHAUST SYSTEMS

System Requirements □□□ The exhaust system has to carry the exhaust gases out of the engine to a safe position on the vehicle, silence the exhaust sound and cool the exhaust gases. It also has to match the engine gas flow, resist internal corrosion from the exhaust gas and resist external corrosion from water and road salt.

System Components The exhaust system consists of the exhaust manifold, silencers, mufflers, expansion boxes and resonators. It also has down or front pipes, intermediate and tail pipes, heat shields and mountings. Also included are one or more catalytic converters, one or two lambda sensors and an outlet for the exhaust gas recirculation system.



Exhaust system

High Temperatures □□□ The exhaust gases are at a very high temperature when they leave the combustion chambers and pass through the exhaust ports. The exhaust manifold is made from cast iron in order to cope with the high temperatures. The remainder of the exhaust system is made from steel, which is alloyed and treated to resist corrosion.

Down Pipe or Front Pipe The down pipe, or front pipe, is attached to the manifold with a flat, or ball, flange. This joint is subject to bending stresses with the movement of the engine in the vehicle. To accommodate the movement and reduce stress fractures, many flange connections have a flexible coupling made from a ball flange joint and compression springs on the mounting studs.

Exhaust Movement Another system to accommodate movement is a flexible pipe constructed from interlocking stainless-steel coils, or rings. Where a flexible joint is not required, the front pipe may be supported by a bracket welded to the pipe which is bolted to a convenient position on the engine or gearbox. Where a catalytic converter is used, it is fitted to the front pipe so that the exhaust heat is used to aid the chemical reactions taking place within the catalytic converter. The front pipe connects to an expansion box or silencer. The exhaust gases are allowed to expand into this box and begin to cool. They contract on cooling and slowdown in speed.



Flexible joint

Silencers or Mufflers

Silencers are constructed as single- or twin-skin boxes, and there are two main types: The absorption type, which uses glass fibre or steel wool to absorb the sound; and the baffle type, which uses a series of baffles to create chambers. In the baffle type, the exhaust gases are transferred from a perforated inlet pipe to a similarly perforated outlet pipe. These silencers have a large external surface area so that heat is radiated to the atmosphere. Additional pipes and silencers carry the exhaust gas to the rear.

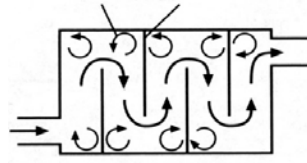

Baffle silencer

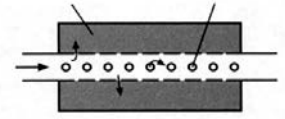

Absorption silencer

Joints Pipes are joined together by a flange, or clamp, fitting. Flange connections have a heat-resistant gasket and through-bolts to hold the flange together. Clamp fittings are used where pipes fit into each other. The larger pipe is toward the front and the smaller pipe fits inside. A ring clamp, or 'U' bolt and saddle, are tightened around the pipes to give a gas-tight seal. An exhaust paste is usually applied to improve the seal of the joint. The exhaust system must be sealed to prevent toxic exhaust gases from entering the passenger compartment.



Flange connections



Pipe connections

Exhaust Mountings A small water-drain hole may be used on the underside of some silencers. This is to reduce internal corrosion from standing water in the silencer body forming on short-journey usage. The exhaust is held underneath the vehicle body on flexible mountings. These are usually made from a rubber compound and many are formed as a large ring that fits on hooks on the vehicle and the exhaust-pipe brackets. Other mountings are bonded-rubber blocks on two steel plates.



Flexible...



Mountings

Heat Shields Heat shields are fitted to the exhaust, or to the vehicle floor, to prevent the ignition of sound-deadening and anti-corrosion materials. Catalytic converters become very hot during operation. It is important, therefore, that all heat shields are correctly fitted and positioned to insulate the vehicle from the high temperature of the catalytic converter.

Catalytic
converter in
position

 Describe the difference between a baffle and absorption silencer.

 Look back over the previous section and write out a list of the key bullet points here:

TOOLS AND EQUIPMENT

Tools and Equipment Almost all work on air-supply, exhaust- and emission-control systems can be carried out with general workshop tools and equipment. Check with the vehicle workshop manual before carrying out any repair work to see if dedicated tools are specified.



Normal tools are used for most jobs

Pressure Chargers The overhaul of pressure chargers may require special equipment. Bearings may need to be replaced, or components set to very accurate tolerances. Manufacturer's tool kits will include the mandrels, supports and jigs to be used to ensure proper completion of the work.



Many special tools...



Are used for turbo work

Tools for Exhaust Removal

Some useful tools for exhaust-system removal

are chain wrenches for twisting seized pipes, and oxyacetylene welding equipment for freeing up rusted joints. An air chisel may be necessary for cutting off components that will not be reused.



Chain cutter



Air cutter



Chisels



Hammer!

Exhaust Materials Exhaust materials, which are used frequently, include jointing compounds and a range of pipe clamps and hangers. These can be adapted to suit many applications.

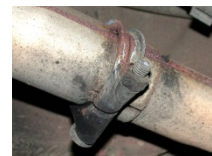

Exhaust 'U' bolts



Exhaust sealant



Look back over the previous section and write out a list of the key bullet points here:

ROUTINE MAINTENANCE

Introduction The abbreviation R&R is short for "remove and refit" components, or "remove and reassemble" components. Air supply, exhaust and emission control-system components will usually be removed, inspected and repaired, or replaced, when a defect has been diagnosed. Other components are replaced, or stripped and cleaned, at scheduled mileage or time intervals.

Scheduled Servicing Scheduled-service requirements for the air supply, exhaust and emission-control systems overlap other engine-system inspections, e.g., faults detected by exhaust-gas analysis, listening for misfire and uneven idle, and looking for oil leaks and the burning of oil. This latter is seen as blue smoke in the exhaust gas, which can be caused by a number of faults. Identifying the causes that are due to defects in the air-supply, exhaust- and emission-control systems are covered in this learning programme.

Original Equipment In consideration of other people's property, always be careful to use approved parts for all components that can affect exhaust emissions. Original equipment manufacturer's (OEM) parts may be required to meet the regulations.

Air Supply The air supply should provide sufficient clean air for complete combustion of the fuel that has been delivered during the induction stroke. Any restriction in the air supply, due to a blocked air-cleaner element or other obstruction, will give abnormal exhaust-gas readings. Always look at the area in front of the air-intake duct to check that there is nothing that can be drawn into, or against, the entry to the duct and therefore block the airflow.



This air filter needs replacing!

Preheating □□□ Preheating of the airflow for carburettor and single-point injection systems reduces the amount of harmful exhaust-gas emissions during the engine warm-up phase. A quick observation of the operation of the control flap in the air-cleaner intake duct when the engine is cold, and again when hot, is all that is needed to see that this essential component is working correctly.

Exhaust-Gas Leaks □□□ A blocked, or defective, exhaust system can produce uneven running and a lack of power. Exhaust-gas leaks from the manifold, or front pipe, can produce a screech, similar to the sound of a slipping drive belt. Exhaust-gas leaks can enter the passenger compartment and make the driver and passengers drowsy. These may not be detected easily but are potentially harmful. It is therefore important to check exhausts for leaks very carefully.

Catalytic Converter Checking the operation and performance of a catalytic converter is a regular scheduled-service and annual statutory test item. Measurement of the exhaust-gas constituents, to check the operation of the catalytic converter, is described in the workshop manual, or other data book, for the actual vehicle being inspected. When the catalytic converter is part of an engine-management system with closed-loop control of fuel delivery, an exhaust-gas analyser, with voltage measurements for the lambda sensor, is used.



Lambda sensor

Air-Injection Systems Air-injection systems are used to add oxygen into the exhaust flow when the engine is operating on a rich mixture. This occurs during warm-up and acceleration. The control system will be set for one, or both, of these conditions, depending on the vehicle and other fuel-delivery management methods. These systems should be checked in accordance with the manufacturer's instructions and specifications.



Air-injection pipes

Crankcase Ventilation Inspection and cleaning, or replacing, the filter and oil separators of the crankcase-ventilation system is important for correct operation. This will also prevent oil leaking from the engine. Although the frequency of the inspection of the crankcase-ventilation system is at high-mileage, or yearly, intervals, it is important to look for symptoms during all service operations. Checking for correct operation of the EVAP and EGR systems will usually be required when faults are detected, but they should be considered whenever a misfire, or uneven idle, is heard.



Oil separator connected to the crankcase

Supercharger and Turbocharger Service

Supercharger and turbocharger service requirements are for security, leakage, and condition of the units, connecting pipes, control devices and drive belts, or gears, when fitted. Report any abnormality to the owner or driver of the vehicle.



Turbocharger

Recommended Procedure The descriptions provided in this section deal with the components for individual replacement, rather than as a part of other work. Always refer to a workshop manual before starting work. You will also need to look for the recommended procedure, special tools, materials (such as sealants), tightening sequences and torque settings. Fit a 'memory keeper' and then disconnect the battery, unless the engine has to be started to carry out a test procedure.



Worksheet Routine maintenance inspections,

lubrication and replacement of parts.

This area of work can vary considerably depending on the type of vehicle, its age and mileage. It is important to carry out a brief check that all systems are working correctly at all scheduled service intervals. Carry out the inspections described in the systems-performance section in full or briefly, depending on the performance of the engine. Take into account any report from the driver of the vehicle.

Lubrication Requirements There are few lubrication requirements other than linkages and pivot points and these are specified by the vehicle manufacture. Parts replacement includes the air-cleaner element and crankcase-ventilation filters. At longer service intervals, the ventilation system will require cleaning and the replacement of rubber hoses. In some cases, the non-return valve between the inlet manifold, or air intake, and the crankcase will need replacing. Any other required work will be specified by the vehicle manufacturer.



Lubrication is important



Worksheet Replace air-cleaner element - clean

dust/dirt from the air-cleaner housing and ducts. Carefully open the air-cleaner housing and remove the element. All modern vehicles use a micro-porous paper element, which can be cleaned at half-service intervals by reverse-blowing with an air line. Do not blow into the paper because this will compact any dust particles and block, rather than clean, the element. Use a vacuum cleaner or damp cloth to remove all the loose particles of dirt that accumulate in the housing and duct pipes.

Replacement Filter Element Check that a replacement filter element is correct for the vehicle and that it matches the dimensions of the one being replaced. Do not force an oversized element into the air-cleaner housing because this can damage the housing and/or distort to leave a gap through which unfiltered air can flow into the engine.



Air filter and housing



Worksheet Inspect and clean PCV

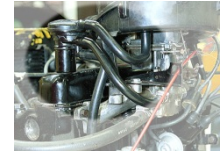

Crankcase-ventilation system

(positive crankcase ventilation) components - check security of all hoses/valves/filters, etc.

There are many variations on positive crankcase ventilation systems and it is advisable to follow the manufacturer's instructions for checking, cleaning and the replacement of parts. Because the time intervals are long, it is important that this work is not missed. If asked by a customer option, the advice given should be that it is carried out at three- to four-yearly intervals.

Crankcase-Ventilation System □□□ One common point with all systems is ensuring that there is no blockage. This can occur because of lacquer build-up when oil changes have not being carried out at the correct service intervals. Any blockage in the system increases the risk of oil leakage from the engine and high oil consumption. Any vehicle that has blue smoke visible in the exhaust should have the crankcase-ventilation system cleaned before any further diagnostic work is carried out.



Look back over the previous section and write out a list of the key bullet points here:

AIR AND EXHAUST - CUSTOMER CARE

Customer Care Ignition problems account for many vehicle breakdowns. There are early warning signs that are often ignored by drivers. These include slight misfires, uneven running particularly when the engine is cold, taking slightly longer to start than normal, and other similar problems leading the driver to believe that it is unnecessary to organize a repair. It is these sorts of problems that develop and result in a vehicle breakdown at the most inconvenient time.

Cold-Starting Problems □□□ A cold-starting problem may occur even though the car started without a problem when the weather was warmer.

If the driver had had the vehicle inspected earlier, the problem would not have arisen. A new set of plugs may have been all that was needed.

Customer Records There are two ways that a company can support their customers to prevent ignition-system breakdowns. The first is to maintain customer records and a call-in system for the replacement of necessary parts at specified intervals.

Seasonal Advice The second is to provide advice at suitable times of the year on the type of problem that may be experienced and how to identify the early-warning signs. Most of these problems are seasonal and a seasonal-advice programme may be a sensible approach in some parts of the country.

Pre-Winter Inspection There are two situations when ignition systems require special attention. A seasonal pre-winter inspection as part of the winterization programme and an 'infrequent-use' service programme. The pre-winter service should include a condition check of components, a new set of spark plugs if any doubt exists regarding the old set, and a water-repellent treatment of the ignition cables.

Short Journeys Infrequent use and short-journey use can lead to premature failure of the spark at the spark-plug tip. This occurs when the self-cleaning action of the spark-plug tip fails as a result of the engine never reaching a normal operating temperature. This results in a build-up of carbon compounds on the insulator nose conducting the secondary circuit to earth, and therefore no spark is produced.

Advising Customers There are two ways to overcome this problem. One is to suggest to the customer that a longer run is made at regular intervals so that the engine fully warms up and the self-cleaning action of the plugs is achieved. The other is to have the plugs removed and cleaned at regular intervals before the carbon compound build-up develops to a point where the engine performance is affected.

Catalytic Converters For all vehicles fitted with a catalytic converter, it is important that no excess fuel is allowed to enter the converter. If it does, it will burn and overheat the converter causing premature failure. Advise customers that any misfire, however slight, should be corrected as soon as possible. A new set of spark plugs is much cheaper than a new catalytic converter.



A damaged catalytic converter



Customers will appreciate advice that saves money!



Look back over the previous section and write out a list of the key bullet points here:

IGNITION

INTRODUCTION

Ignition □□□ An ignition system is required for petrol engines to provide a spark in each combustion chamber to ignite and begin the combustion of the fuel in the cylinder. The abbreviation SI, which stands for Spark Ignition, is sometimes used to describe these engines.

The spark occurs when a high-voltage electric current is made to jump across the gap between the electrodes of a spark plug.

Spark Plug □□□ A spark plug is screwed into the cylinder head with the electrodes sitting just inside the combustion chamber.

High Voltage A high-voltage electric current of approximately 10,000 volts is needed to jump across the gap between the spark plug and electrodes when the engine is at normal operating conditions and all components are properly adjusted. A higher voltage is required if the spark-plug gap is too large.



Spark plug

Ignition Coil □ The high voltage is produced in the ignition coil and distributed to the spark plugs by thickly insulated cables and conductors in the distributor. These components make up the high-voltage secondary circuit.



Ignition coil

Primary Circuit □ There is also a primary circuit operating at, or below, battery voltage. The primary circuit controls the secondary circuit for both the production of the high voltage from the coil and the ignition timing.

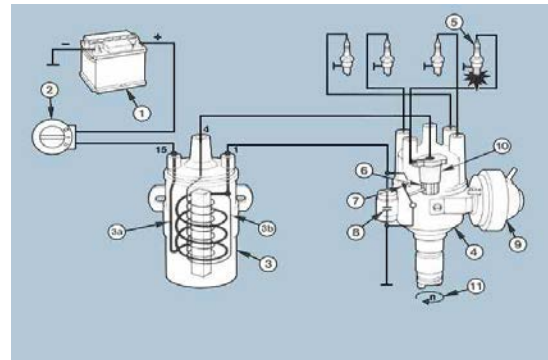

Ignition circuit

Timing Ignition timing is given in degrees of crankshaft rotation. Zero degrees is at top dead centre (tdc) of the piston stroke. Degrees before (bt dc) or after (at dc) top dead centre refer to an amount of crankshaft rotation. Timing marks on the engine at tdc, and settings of degrees before tdc, are provided for checking and adjusting the ignition timing. The timing marks are located on the crankshaft, or flywheel, and on the engine block, or a cover panel.

Advanced Ignition If the ignition timing is off, the engine can be damaged. Ignition occurring too early is called advanced and produces knocking, or pinking, heard as a rattle when the engine is under load, or accelerating. Fuel consumption and exhaust-gas pollution increase. Using fuel with a lower octane rating than that specified for the engine will also cause pinking.

Retarded Ignition Ignition occurring too late is called retarded and causes overheating, poor performance, increased fuel consumption and exhaust-gas pollution.

Developments Ignition systems have developed during recent years to meet the ever-more stringent specifications of exhaust-emission regulations.



Conventional system



System requiring no distributor

These regulations have required reductions in all harmful gas emissions, and engine designs that ensure the reliability of meeting the specifications for many thousands of miles of vehicle use.

Early Systems Early ignition systems, using distributors for control of the ignition spark and timing, could not provide accurate and reliable ignition performance for more than a few thousand miles.



Distributor



HT components

Mechanical Components The mechanical components in the distributor that controlled the primary-circuit function, and the automatic changes in ignition timing for speed and load, suffered from wear and fatigue. They required frequent inspection, lubrication, replacement of parts and accurate resetting of the ignition timing to maintain their condition and performance.



Contact-breaker system



Advance mechanism



State FOUR disadvantages of contact-breaker ignition systems.



Look back over the previous section and write out a list of the key bullet points here:

COMPONENTS

Primary Switching □□□ The ignition spark produced by the secondary-voltage discharge from the ignition coil occurs when the electric-current flow through the primary circuit is switched off. The switching of the primary circuit, and the control of the advance and retard for speed and load conditions was, until recently, carried out by components in the distributor.

Mechanical Switching The switching on older designs was achieved mechanically by a cam and contact breaker. On early electronic systems, the switching was carried out by a pulse generator and amplifier module.



Contacts



Distributor with vacuum control



Pulse generator



Amplifier

Electronic Switching These designs have been followed by ignition modules using sensors in a secondary circuit-switching distributor, or located at appropriate points on the engine. The latest designs use electronic primary circuits, ignition-timing controls and ignition coils connected directly to the spark plugs.



Direct ignition

Contact Breakers The first photograph here shows a simple contact-breaker-type distributor with a mechanical-timing advance for engine speed and a vacuum control for engine load. The other main components are the vehicle battery, the ignition switch, coil, spark plugs and the high-tension (HT) leads. The vehicle battery and the generator (or alternator) provide the electrical supply for the ignition system.



Contacts & vacuum control



Battery



HT leads



Coil

Ignition Switch The ignition switch is a multi-function switch that includes battery supply to 'ignition-on' systems, starter operation, and usually incorporates a steering-column lock when the key is removed. Some ignition switches include a parking-light function. The ignition switch is used to provide an electrical supply to the primary circuit of the ignition system.



Steering lock and switch

Distribution □□ The distributor controls the switching of the primary current and, therefore, the coil secondary-circuit high-voltage pulses. It is pre-set to a basic timing position and then controls ignition timing automatically for speed and load. Secondary-circuit components distribute the high-voltage electric pulses to each spark plug in sequence with the engine-firing order.

Contact Points Inside the distributor are the switching components consisting of a cam attached to the top of the distributor spindle, and fixed (earth) and moving (insulated supply) contact points attached to a base plate. The two contact points give this switch its name of contact-breaker points



Points

Cam Lobes The moving contact is fitted with a spring to hold it closed, and a 'heel' that runs on the cam to make it open. When a cam lobe meets the heel, the points are opened and, as the lobe moves on, the points are closed by the spring. The contact breaker is secured to a base plate fitted with ground contacts, or cables, to complete the electric circuit.

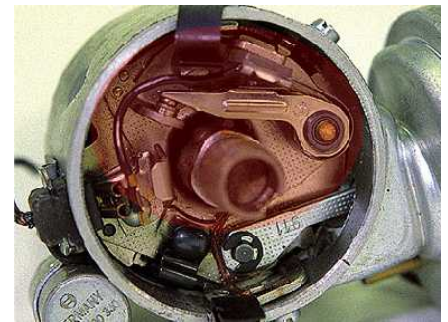

Distributor cam

Cam Shape The cam shape is a compromise to produce high and low engine speed coil outputs. The dwell angle, during which the coil energizes, is usually about 50° for 4-cylinder engines. This limits high engine-speed performance, and some engines with more than six cylinders may be equipped with two sets of contact breakers and ignition coils. The return spring for the moving contact has a limited ability to close the points effectively at high-engine speeds and contributes to a further deterioration of high-speed ignition performance.

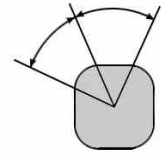

Dwell angle



Cam lobes

Distributor Drive The distributor spindle is driven by gears on the camshaft at camshaft speed, which is half the crankshaft speed. The switching action is therefore automatically controlled by rotation of the engine and, provided the distributor is correctly adjusted, is timed to provide a spark at the correct point of crankshaft rotation and piston position in the cylinder.



Drive gears



Dog drive

Induced Voltages When the primary-circuit current is switched off in the coil, there are induced voltages in both the primary and secondary coils. The secondary-winding voltage is used to provide the sparks at the spark plugs.

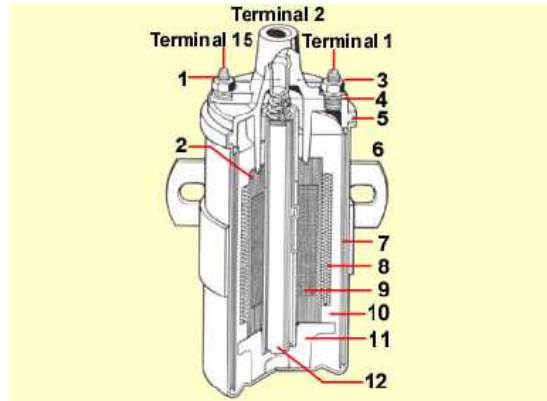

Arcing The increase in primary-circuit voltage over battery voltage is considerable and would cause severe arcing at the contact-breaker points. This would overheat the points and cause rapid wear. Also, it would reduce the secondary winding voltage and pulse pattern and give a weak spark. To control, or suppress, the temporary high voltages in the primary circuit and the harm that would be caused, an electrical capacitor, or condenser, is fitted across the points.

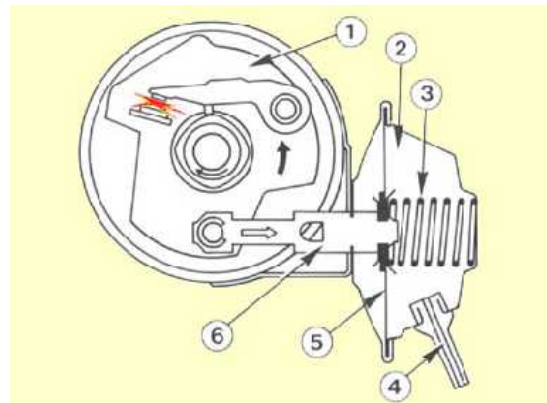

Capacitor The capacitor consists of two metal plates that are separated by an insulator. Each plate is fitted with an electrical terminal and connected to opposite sides of the contact-breaker points.

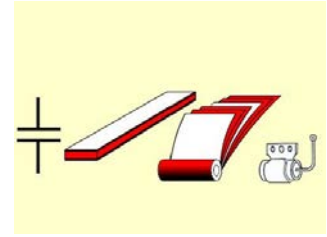

Capacitor or condenser

Capacitor Action A capacitor has the ability to store and discharge an electric charge. The pulses in the primary circuit are taken into the capacitor and then returned in the opposite direction. This has the effect of holding the primary-circuit voltage down and stopping the primary-current flow very quickly. These two effects prevent rapid wear of the contact-breaker points and greatly improve the performance of the coil.



Capacitor action

Ignition-Timing Moment □□□ The ignition-coil pulses of high voltage occur when the primary-circuit current is interrupted when the points open. This is the moment when a spark is provided in the combustion chamber to begin ignition of the fuel. This moment is known as the ignition-timing position and varies by more than 30° of crankshaft rotation in most engines. The variations are needed to respond to the changes in the speed and load of the engine.

Advance and Retard Mechanisms

These changes are provided automatically by a mechanical-advance mechanism for engine speed and a vacuum system for engine load.



Automatic advance



Speed advance

Speed Advance and Retard The mechanical-advance mechanism is fitted to the distributor spindle, below the cam. Two pivoted weights are fitted to a plate, which is attached to, and rotates with, the spindle. The cam has a hollow centre and fits over the distributor spindle on which it is free to rotate. Fitted below the cam are levers locating with the weights. Springs are attached to the levers to hold the cam in a retarded position.



Speed-sensitive advance mechanism

Centrifugal Weights □□□ Rotation of the spindle causes the weights to be thrown outwards by centrifugal force. The movement of the weights acts on the levers and, in turn, moves the cam forward on the spindle. This advances the cam causing the points to open earlier and advance the ignition timing. The springs retain the outward movement of the weights and degrees of advance, and pull the cam back as the speed reduces.

Vacuum Advance □□□ The vacuum system uses the vacuum that exists in the inlet manifold at the base of the carburettor. The vacuum is applied to a diaphragm in a vacuum unit fitted to the distributor. The vacuum unit uses the variable force that is obtained as a result of the difference in pressure between the engine vacuum and atmospheric pressure. When a vacuum exists on one side of the diaphragm, atmospheric pressure causes the diaphragm to deflect into the vacuum. A return spring controls the amount of deflection and pushes the diaphragm toward its rest position when the vacuum reduces.

Vacuum Unit □□□ A tie rod connects the vacuum unit to the distributor base plate carrying the contact-breaker points. The base plate is made in two parts that swivel one on top of the other. The fixed base plate is fitted to the distributor body. The moving base plate swivels on a central boss on the fixed plate. An electrical contact, or cable, joins the two plates for electrical conductivity of the primary circuit to ground.

Load Advance and Retard

When the diaphragm moves under engine vacuum and atmospheric pressure, the tie rod pulls, or pushes, the moving base plate so that it rotates on the fixed base plate. This moves the contact-breaker points in relation to the cam and alters the ignition-timing position. In a simple vacuum unit, the timing is advanced when the vacuum is greatest (lowest pressure about 500 mbar), for instance during idle, cruising and overrun. The advanced-ignition timing compensates for the slow ignition of the weaker mixture at these load conditions.

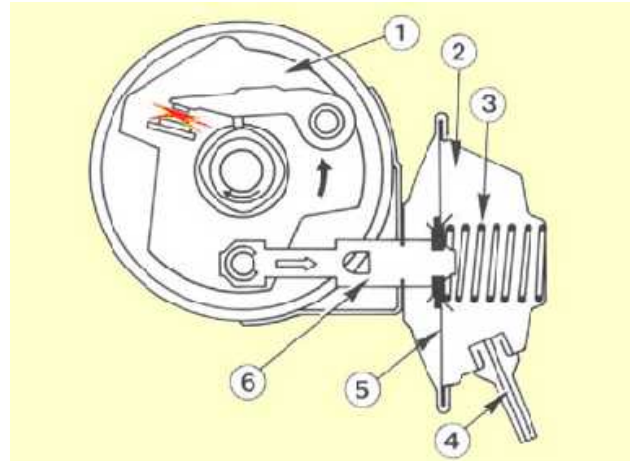

Partial Load Some vacuum-control units incorporate an advance and retard unit that gives improved exhaust emissions during changes in load conditions, for instance when moving from partial load to full load during rapid acceleration.

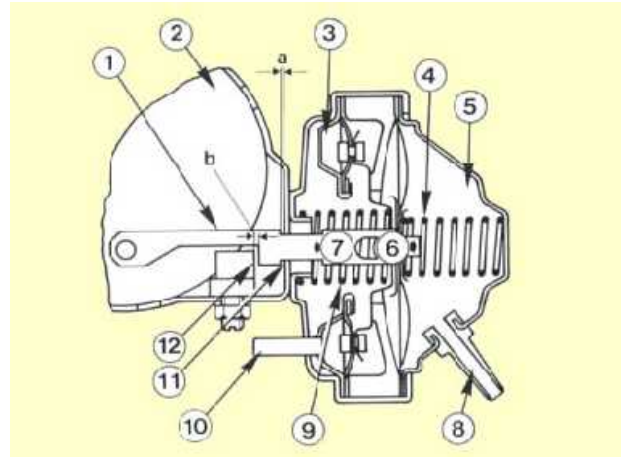

Dual-chamber vacuum unit

Starting The circuit diagram for a basic contact-breaker ignition system is shown on this screen. This circuit requires a good battery voltage to produce a good-quality spark. During engine starting on a cold day, the available voltage to the ignition circuit drops by as much as 3 volts. This reduces the coil output at a time when the best-possible spark is required.

Ballast Resistor To overcome this problem, most distributor-ignition systems were fitted with a ballast resistor in the primary-circuit supply to the ignition coil. The ignition coil was designed to operate on the reduced voltage that the resistor produced, which was 6 to 9 volts for most systems. During starting, the supply to the coil bypasses the resistor and supplies the actual battery voltage, although this is reduced because of the large current draw to the starter motor.

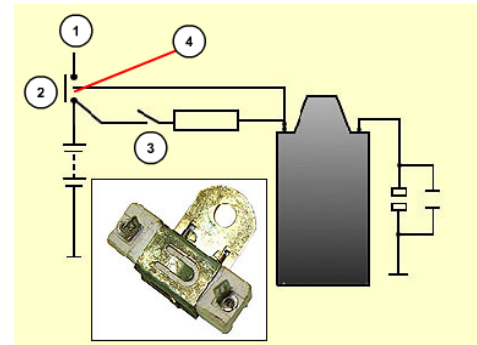

Ballast circuit

Bypass Circuit The bypass supply originates from the starter-motor solenoid. The actual voltage supplied to the coil is usually greater than the coil-rated voltage and the coil output is therefore boosted temporarily during engine starting. Coils for use with ballast resistors are not interchangeable with coils for battery-voltage systems.

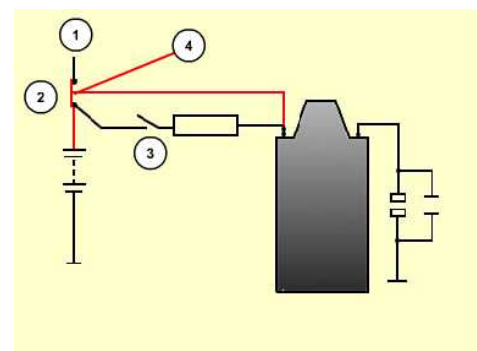

Bypass operation

Summary □□ The purpose of an ignition system is to produce a spark in the correct cylinder at the right time. All ignition systems achieve the high voltage required by switching an ignition coil on and off.



State the purpose of a ballast resistor in an ignition system.



Look back over the previous section and write out a list of the key bullet points here:

SPARK PLUGS AND SECONDARY CIRCUIT

Spark Plugs The spark plugs are fitted into the combustion chambers at the top of each cylinder. The electric current in the secondary circuit is sufficient to make the air gap between the electrodes conductive, and a spark occurs. A higher voltage is needed to initiate the spark than is needed to maintain it. The spark has sufficient heat and energy to ignite the fuel in the combustion chamber.



Plugs in cylinder head

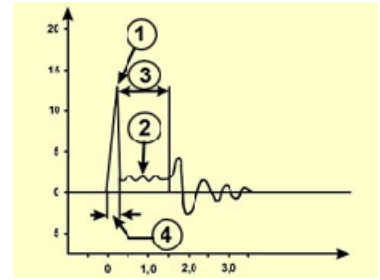

HT waveform

Combustion The conditions in the combustion chamber make the production of a spark difficult. There is a high pressure in the air charge following compression and the fuel particles make that air charge damp. Insulation of the secondary-circuit components must be able to prevent any premature grounding of the high voltage. Damp-proofing is also required to prevent an alternative conductive pathway being formed.



Damp-proofing

Electrodes Spark plugs consist of a centre electrode in a ceramic insulator fitted inside a steel body, and an earth electrode, or electrodes, welded to the body of the plug. The spark-plug body is threaded to fit the cylinder head where it protrudes into the combustion chamber. A gas-tight seal is made between the insulator and body of the plug, with sealing rings and crimping of the body to the insulator. Gas sealing at the cylinder head is made with a compressible gasket, or taper seat.

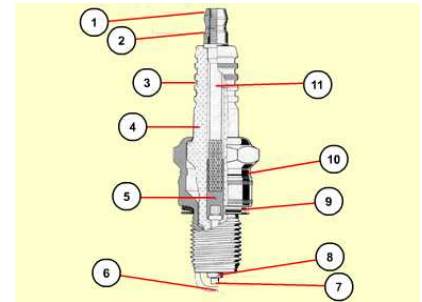

Cross-section of a spark plug

Matching Spark Plugs Spark plugs are matched to the engine to suit the cylinder-head design details and for normal driving conditions. They are selected from a range of varying types. The features of spark plugs are reach and thread diameter, gas-sealing method, heat range, and other design features. The gap between the electrodes is specified by the plug and engine manufacturers to ensure that the engine gives the best possible performance.



Plug features

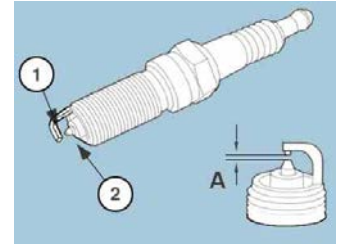

Spark-plug gap

Plug Reach and Diameter The reach, or length, of thread, and the thread diameter, refer to the threaded section of the plug and are used to match the plug to the thread dimensions for screwing into the cylinder head.

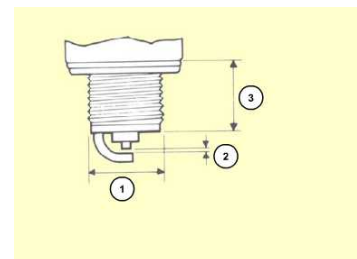

Plug reach and diameter

Sealing Spark Plugs Two common types of gas sealing are used: A compressible copper gasket and a taper seat. These are not interchangeable. The tightening torque of the spark plug into the cylinder head is different for each type of plug. Always refer to torque data and tighten appropriately because correct fitting affects the heat dissipation and, therefore, the performance and life of the plug.



Heat Range The heat range of spark plugs is determined by the ability of the plug to maintain a constant temperature at the plug tip in the combustion chamber. The normal temperature range at the plug tip should be at least 500°C, and at about 800°C for optimum performance. The lower temperature is sufficient to give a self-cleaning action at the electrodes and an extended life.

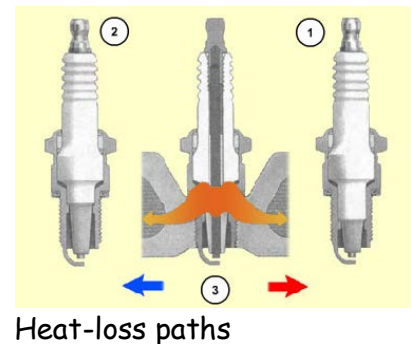

Self-Cleaning The self-cleaning action prevents the build-up of soot, oil and carbon deposits, which are burnt off above 500°C. Carbon deposits on the plug tip and insulator provide grounding paths for the secondary-circuit current and cause misfiring of the engine.

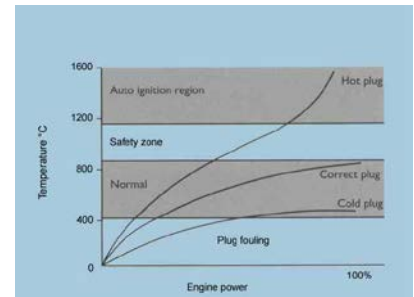

Plug temperature

Pre-Ignition Exceeding the upper limit would make the spark tip glow and ignite the mixture before a spark is initiated. The result of any pre-ignition is engine knocking heard as a 'pinking' sound, poor engine performance and fuel economy, and the probability of severe engine damage.

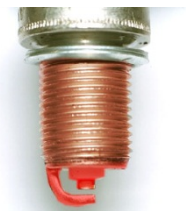

Overheated plug!

Heat Paths The heat range of the plug is governed by the length of the heat-dissipation path of the central insulator. A hot-type plug has a low thermal value and has a limited heat-transfer path. A cold plug has a high thermal value and transfers heat away more easily. Only in exceptional circumstances is it necessary to use plugs of a different heat range than the ones specified for the vehicle.

Plug Variations The other design features of plugs are the references to changes in the basic plug type. One development that has since become the norm is the extended tip, now being considered as the standard electrode position. The old design does not have the centre and earth electrodes extended from the plug tip.

Plug-Tip Designs There is a wide range of plug-tip designs for the wide range of engine applications. Many of these are for non-vehicle uses such as lawn mowers, chain saws and marine engines. A special range of plugs has more than the one earth electrode used on standard plugs. These are referred to by product name, or as ring-electrode types. The pressures and forces at the plug tip following ignition can lead to distortion of the earth electrode. To overcome this problem, reinforced earth electrodes can be specified.



Old tip design



Two electrodes



New tip design



Four electrodes

Spark-Plug Cores The connection, from the plug terminal to the centre electrode tip, has been developed in a number of ways. An electrical-resistive core is used to provide radio suppression. The electrodes of a standard plug are made from a nickel alloy. Special-purpose and long-life plugs use other alloyed elements such as chrome, copper, silver and platinum. These materials may also be used to coat the tip or, in the case of copper, be used as a core for the centre electrode.

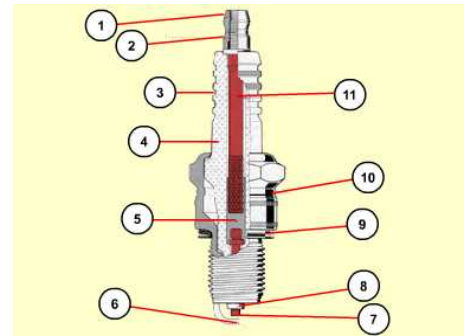

Plug core

Selection of the Correct Plug The range of design details that are included in spark-plug classification and identification are code letters, or numbers, for thread diameter, length of thread (reach), design features such as radio suppression, taper seat and electrode type, the heat range, and the electrode gap. Special materials used in the construction of the plug are included in the manufacturer's name for the range of plugs, or by a code letter in the identification classification.



Spark-plug part numbers

Secondary Circuit The secondary circuit wires, or HT leads, are thickly insulated to ensure that the electric current reaches the spark plugs. Some plug wires have radio-suppression insulation to limit electromagnetic-wave transmissions. The wires, with a resistive core inside a thick outer insulation, limit and smooth the secondary current.

The connectors and terminals are also designed to provide radio suppression in some cases.



High-tension leads



Lead details



HT connections

Cap and Rotor The distributor cap and rotor are made from a hard plastic material and have electrical conductors for distribution of the high voltages of the secondary circuit from the ignition coil to the spark plugs. The distributor cap is secured to the distributor body with spring clips, or screws, and located with a lug and slot to ensure correct positioning for number 1 cylinder and the engine-firing order. The rotor sits on top of the distributor spindle and is also located with a lug and slot.



Rotor in place

Interior of
cap

Capacitor-Discharge Ignition One other type of ignition system that is used on some high-performance vehicles is a capacitor-discharge (CD) system. This system produces a very high voltage in the secondary circuit, but is of short duration. A special coil is used of a tougher construction than a conventional coil. It is called a pulse transformer, although it is internally wound with primary and secondary windings like a conventional coil. It receives pulses of primary-circuit voltage at about 400 volts, and gives secondary outputs at about 40,000 volts.

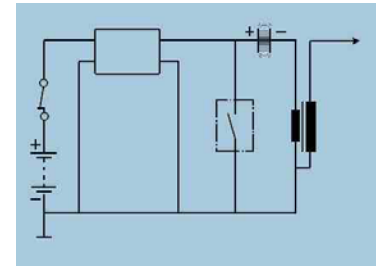

Capacitor discharge block diagram

Energy Charge The energy charge is very rapid and the primary- and secondary-electric pulses are so close together that no dwell control is needed. The secondary voltage is constant over a wide speed range. The system uses the charging of a capacitor to produce a high primary voltage. The charging is provided by an inverter, which changes battery voltage to about 400 volts.

 Explain why a hot plug is fitted to a cold engine and a cold plug is fitted to a hot engine.

 Look back over the previous section and write out a list of the key bullet points here:

ELECTRONICS AND SYSTEM OPERATION

Microelectronics The developments in microelectronics and solid-state circuitry produced suitable replacements for some of the ignition primary-circuit mechanical-switching components. The use of these reduced some of the wear problems.



Amplifier



Pulse generator

Transistor Switching Transistor switching permits very low control currents and new types of sensors that send signal currents to the transistors. These have no mechanical contact and are wear-free. These developments have improved ignition-timing reliability, and further changes have improved the primary-circuit performance resulting in better spark generation.

Open Loop Microprocessor-ignition systems were originally open-loop systems using engine position, speed and load sensors to provide data. The data were compared in the engine-control module to a pre-programmed map of ignition-timing positions for all conditions.

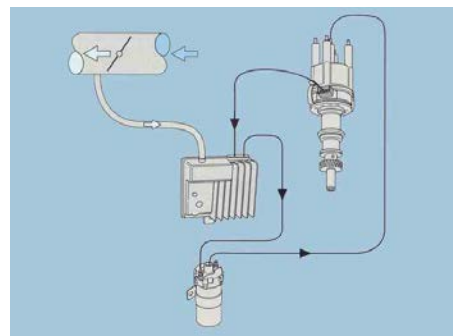

Digital system

Engine-Control Module An engine-control module carries out all the functions of the primary circuit, including spark-generation control, and the advance and retard of the ignition timing for speed and load conditions. Because there are no moving parts, the system is wear-free and has high levels of accuracy and reliability.

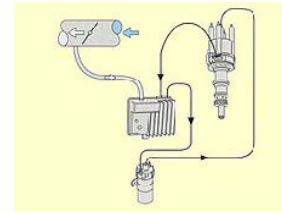

Digital system

Electronic Control Unit Many modern ignition-control circuits in the electronic control unit (ECU) are closed-loop systems using a knock sensor to provide feedback to the ECU, which adjusts the timing to a point just a few degrees after the position where the engine knocks. This provides the most effective ignition-timing position.

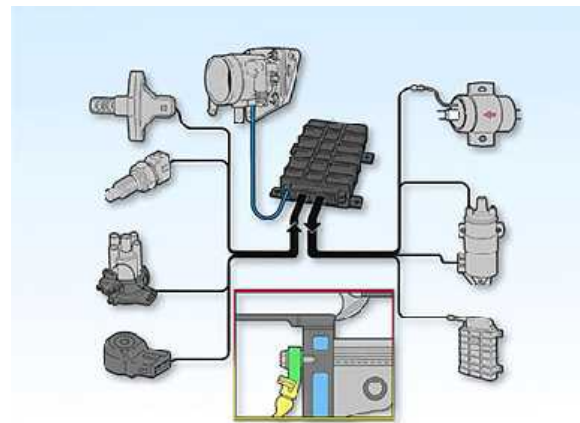

Integrated Systems The integration of fuel and ignition electronic-control microprocessors into one engine-management system is now common. The latest developments have seen the connection of all vehicle electronic-control systems to form a power-train control module (PCM), or a vehicle control module (VCM).

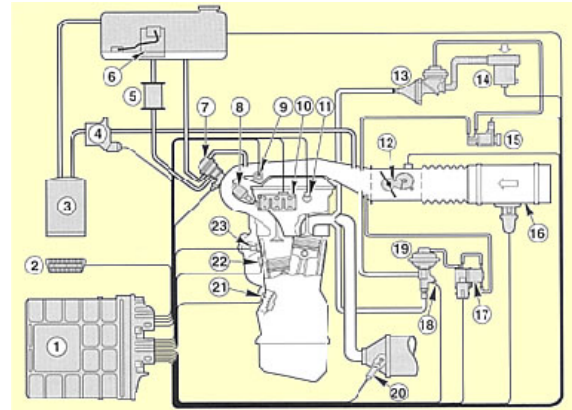

Secondary Circuit The ignition secondary-circuit components remained similar during the early developments of electronic primary-circuit controls. The traditional distributor was fitted with an electrically insulated cap, with turrets for each cylinder and the input from the ignition coil.



Distributor cap



HT Leads

Rotor and Cap A rotor, fitted to the distributor spindle, ran in contact with the centre input contact in the cap, and aligned with the segment conductors for each cylinder in turn as the rotor rotated. The engine firing order matches the rotation of the rotor and the positions of the turrets on the distributor cap.



Rotor in cap

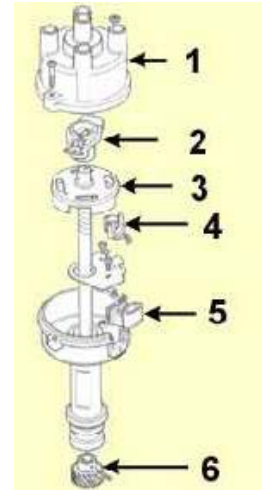

Secondary distributor

Secondary Distributor □□□ The secondary circuit-switching distributor retains the rotor and cap components but the primary-circuit control is fully electronic.

Distributorless Ignition

Distributorless ignition systems (DIS) have a coil, or coils, that are directly connected to the spark plugs.



DIS coil and leads



System requiring no distributor

Spark Plugs Spark-plug design has developed with many changes in the materials used in the manufacture so that spark-plug life is now much longer than it used to be, and plug performance remains consistent for many thousands of miles.



Old spark plugs



New spark plugs

Ignition Coil □□□ The main component of all ignition systems is the ignition coil. It is the part that produces the high voltage that is needed to ignite the petrol by making a spark arc across the gap between the spark-plug electrodes inside the engine combustion chambers. The outputs from the coil are pulses of high voltage that result from automatically switching a control current on and off through the coil. The automatic switching matches the rotation and firing order of the engine and the positions of the pistons.

Transformer

Action The ignition coil is a voltage transformer

consisting of two insulated coils of copper wire wound around a laminated soft iron core. The coils of copper wire, known as windings, are the primary winding (input winding) of several hundred turns, and the secondary winding (output winding) with 15,000 to 30,000 turns. The two windings have a common junction at the primary circuit terminal 1 (standard classification). The primary circuit supply terminal is



A coil is a transformer

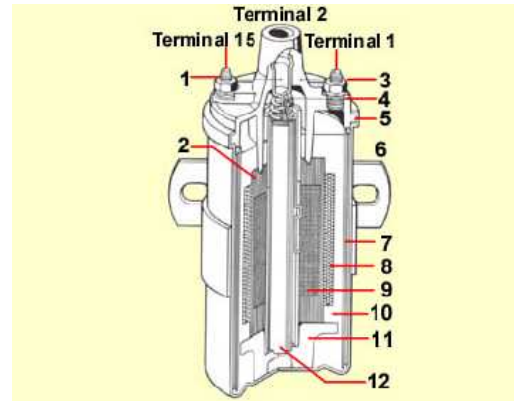

15 and the

secondary winding

High-Output Voltage The maximum secondary-circuit output voltage in a no-load condition is derived from the ratio between the primary and secondary windings. Depending on the type of coil and primary-circuit voltage, the output voltage will be between 10,000 and 30,000 volts. High-output coils can be up to 60,000 volts.

The high voltage is an induced voltage in the secondary windings. The induced voltage occurs as a result of changes in a magnetic field around the soft iron core. The magnetic field passes through the secondary windings and excites, or energizes, the electrons in the copper wire.

All these high voltages are a safety hazard and appropriate precautions must be observed when handling ignition components.

Magnetic Field □□□ The magnetic field is produced as a result of passing an electric current through the primary windings. The soft iron core is magnetized and the magnetic field remains during the time that the primary-windings circuit is closed. When the primary-winding current is opened, the magnetic field collapses abruptly and induces a voltage in the primary and secondary windings.

Primary Current □□ The values of the self-induced voltages are determined by the primary current at the time of interruption, the winding ratio of the two windings, and the rate of collapse of the magnetic field. The maximum primary current is controlled by the battery voltage and the electrical resistance of the entire primary circuit. This is usually between 3 to 4 ohms, giving a primary circuit current of 3 to 4 amps in a conventional coil-ignition system.



Explain how an ignition coil produces a high voltage.



Look back over the previous section and write out a list of the key bullet points here:

DWELL AND TIMING

Low-Impedance Coils Low-impedance coils on modern electronic-ignition systems have a lower circuit resistance and a higher secondary current.



Ignition coil

The coil windings and coil secondary output is matched to the particular engine during the design and development process. The rate of collapse of the magnetic field is determined by the type and condition of the primary circuit, or primary circuit-switching system.

Spark Energy In order to produce a spark across the electrodes of a spark plug, a high voltage is required and, to maintain the spark duration, sufficient residual energy must remain in the coil. This is a measure of coil performance. Some energy remains after the spark cuts out, and dissipates as an oscillating and reducing current in the secondary windings. The voltage at the spark plug is shown on this graph.

Coil-Charge Time The time taken for the primary-current flow to produce the magnetic field in the coil is measured in milliseconds. A typical coil requires about 10 milliseconds, but this is only just sufficient at high engine speeds. The current flows when the ignition is switched on, and the automatic switching allows a circuit to flow to earth and back to the battery. As the engine rotates, the automatic switching turns the current off and the induced current flows.

Dwell The technical term applied to the closed circuit, when the current flows, is called the dwell angle, or dwell period; and to the open circuit, when no current flows, as the open angle, or open period. The important one of these is the dwell period because, if this is too short, insufficient energy is available to give effective ignition of the fuel in the combustion chamber.

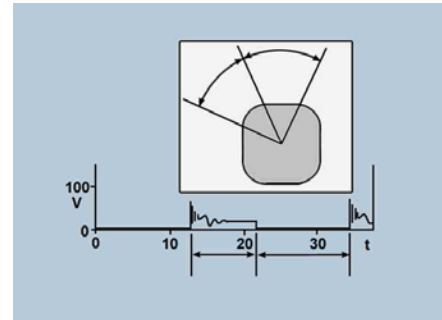

Dwell angle

Variable Dwell Early contact-breaker and simple electronic systems have a fixed-dwell angle. Modern electronic systems have a variable-dwell period that produces an optimum time for the primary-circuit current to flow, irrespective of the engine speed.

Timing The ignition timing is a point in time when the ignition spark arcs across the electrodes of the spark plug. It is measured in degrees of crankshaft rotation before top dead centre (btdc) of the piston.

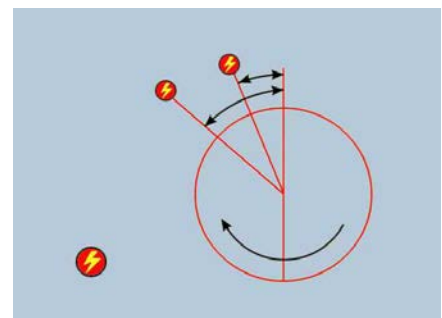

Timing changes with engine speed

Dynamic Timing Ideal ignition timing is dynamic, because it must respond to the speed and load conditions of the engine. Early ignition systems had, as part of the distributor, a static setting and automatic mechanical and vacuum control of advance and retard for speed and load conditions.



Advance weights



Engine components



Vacuum capsule

Static Timing □□□ Accurate setting of the static-ignition timing was essential, as was the frequent inspection and maintenance of the automatic components. Many electronic systems require similar basic timing adjustments, but have electronic-control circuits for the advance and retard functions.

Performance □□□ Ignition timing has a great effect on the performance of the engine. Only when the timing is correctly set is it possible to have maximum engine output (power and torque), fuel efficiency, low exhaust-gas pollution, and avoidance of engine knocking (pinking).

Combustion Pressure The ignition timing is correctly set when the combustion pressure exerted on the piston is converted into the maximum possible force for driving the vehicle. This should occur under all conditions such as engine speed, load, fuel quality, starting, idle and cruising. All energy not converted to useful work will be passed into the engine where it can cause mechanical damage and higher running temperatures.

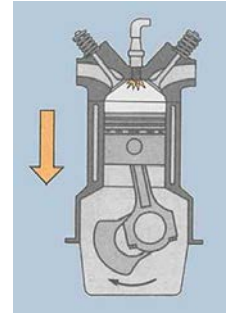

Combustion stroke

Advanced Timing □□□ Advanced-ignition timing will produce combustion pressure too early. The combustion process becomes erratic and pressure waves are produced that strike the piston crown. The resultant forces have little turning effect on the crankshaft and knocking occurs on the piston, connecting rod, crankshaft and bearings.

Knocking The knocking is heard as a 'pinging,' or 'pinking,' sound and can cause serious engine damage, such as burnt piston crowns, spark-plug insulation fracture and thinning of the crankshaft shell bearings, in much the same way as if they had been repeatedly struck with a hammer. Some of the energy is used to raise the engine temperature and can cause overheating.

Retarded Ignition □□ Retarded-ignition timing produces a low combustion pressure and reduced-engine output. The combustion process slows down and less energy is converted to useful work, with the remainder heating the cylinder walls at a greater rate than normal, and the engine temperature increases.



Explain the importance of ignition timing on the combustion process.



Explain what is meant by dwell angle.



Look back over the previous section and write out a list of the key bullet points here:

Dedicated Test Equipment □□□ On early ignition systems, diagnostic tasks could be carried out with general workshop tools and equipment. New systems require specialist diagnostic and measuring equipment. Refer to the manufacturer's workshop manual and data books for precise instructions on the applications and uses of these special items.

Feeler Gauges □□□ Standard feeler gauges are used for contact-breaker ignition service tasks. Plastic, or non-ferrous, feeler gauges are used for checking the air gap on "limb-type" inductive-pulse generators.



Standard
feeler gauges

Test Meters A standard range of analogue, or digital, meters for volts, amps and ohms can be used, but vehicle technicians usually prefer a special meter, which includes dwell readings. A dwell meter is used to measure the ignition dwell angle, or dwell period, when the coil is switched on. On early contact-breaker ignition systems, this is a critical adjustment. The dwell meter is connected to the primary circuit on the coil negative terminal and to the battery earth terminals. A wide fluctuation and oscillating reading would indicate wear in the distributor-drive mechanism.



Standard electrical multimeter



Meter in use



Automotive multimeter



Scanner

Stroboscopic-Timing Lights □□□ Stroboscopic lights are triggered by the secondary-circuit pulses to number one cylinder spark plug, and flash a strobe light onto the timing marks to show the position of the ignition spark. The stroboscopic light is used for dynamic-ignition timing checks and adjustments.

Advance Tests □□□ For testing ignition-advance mechanisms, a test light with a built-in meter is used. This has an adjusting knob, which is twisted to position. The light flashes at a reference point such as tdc (top dead centre), or the timing marks. Alteration from the actual secondary pulse to the repositioned flash is shown on the meter as degrees of advance or retard.

Instruments and Test Meters A

tachometer is used to measure engine speed in revs per minute (rpm or rev/min). It is connected to the ignition primary circuit. Switches on the instrument select the number of cylinders and the type of engine. Some of these instruments have two scales: One for low engine speeds, and the other for high engine speeds. Select the scale to suit the test, or adjustment, being carried out.

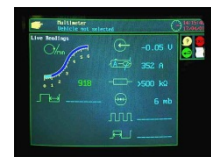

Analyser screen



Reading being taken using an automotive meter

Test Programmes □□□ There is a range of engine analysers available. All are capable of running electronic- and electrical-test programmes. The use of any individual item of test equipment must follow the manufacturer's procedures. Refer to the manufacturer's publications and instructions for the equipment.

Dedicated Test Equipment □□□ Dedicated test equipment is used for specific vehicle applications. These are usually required for a specific vehicle manufacturer, or for a specific system.

Scanners A general range of diagnostic- and ignition-test equipment is available and can be used as a substitute for some of the dedicated test-equipment functions. These tools include fault-code read-out and memory-clearing facilities.



Fault-code reader



Dedicated card



Look back over the previous section and write out a list of the key bullet points here:

ROUTINE MAINTENANCE

Servicing Scheduled service requirements for the engine ignition system consist of checks on the condition of components, and on the performance and operation of the engine.

Obtain data from the vehicle manufacturer's service schedules for the work to be carried out at the mileage, or time, interval.

System Performance □□□ If faults have been reported, the appropriate test should be selected to suit the ignition system. A visual and instrument test is used for distributor systems, and a dedicated test-equipment sequence is used for engine-management systems.

Report any faults found during service operations to the owner, or driver, of the vehicle.

Items for Routine Replacement

Ignition-system items for routine replacement are the contact-breaker points on early distributor systems, the spark plugs and leads, distributor cap, and rotor whenever they show signs of deterioration. A preventative-maintenance programme may include the replacement of secondary-circuit components at 48,000 miles, or 4-yearly intervals.



Contact
breakers



Leads and
distributor
cap



Worksheet Routine maintenance inspections,

lubrication and replacement of parts.

Ignition maintenance is not required at all service intervals, but a quick inspection of the visible components, and a check for misfire, or uneven running, should always be carried out. Where the vehicle has a fault-code read-out system, this should be checked.

Contact-Breaker Systems □□□ Older systems using contact breakers will require replacement of the contact breaker and inspection for condenser defects. At the same time, the cam will need to be cleaned and lubricated with the specified type of grease. Other types of grease are not suitable and should not be used as a substitute. The grease must be compatible with the material used in the manufacture of the heel on the moving point of the contact breaker. The cam-to-distributor spindle may require lubricating oil to be applied through a hole below the rotor arm.

Electronic Systems □□□ Early distributor electronic systems require the inside of the distributor to be inspected. They may require lubrication of the distributor spindle and the timing-advance mechanism by applying oil through a hole below the rotor arm. Check that the anti-flashover shield is in place and in good condition. This is used to protect and insulate the pulse generator from high-voltage arcing between the rotor arm and distributor-cap segment terminals.

Secondary Circuit □□□ On all ignition systems, an inspection of the secondary-circuit wires, terminals, distributor cap and rotor arm is required. These components are liable to deteriorate over time and may need to be changed. At the same time, look closely at other rubber-compound components, such as vacuum hoses, for signs of deterioration. Change any components that are showing cracks, or softening from perishing, or oil contamination.

Ignition Timing □□□ The final checks should ensure that the ignition timing is correct, both at the basic setting and at one or two positions on the advance curve. Check these against the manufacturer's specifications using a stroboscopic-timing light and an engine-speed tachometer. Remove, or leave on, the pipe to the vacuum module depending on the specification. Connect and disconnect the vacuum pipe and observe the change in ignition timing to check that the unit functions correctly.

Road Test □□□ Check the ignition function during a road test. Check the engine both on a light load and under power for uneven running, misfire, hesitation and pinking. Recheck and rectify any faults found.



Worksheet Inspect primary-circuit components -

replace CB (contact-breaker) points and condenser, adjust ignition timing.

This task will vary slightly depending on the type of distributor. However, with all distributor types there are some items that are common. Remove the distributor cap and check the advance mechanism by twisting the rotor arm in the normal direction of rotation. It should twist forward and spring back with the pull from the advance-mechanism springs.

Contact-Breaker Replacement Look closely at the condition and make a note of the wiring arrangements for the points if these are not familiar. Check the base-plate grounding. This will be either a cable, or slipper, between the two parts of the distributor base plate. Disconnect the feed cable and undo the retaining screw to remove the points. Clean the cam and lubricate with grease. Grease the lubrication pad, if one is fitted.



Contact-points cable

Capacitor Condition Check the old points for discolouration. If they show signs of blueing, replace the condenser (capacitor). Pitting is a normal wear pattern caused by the transfer of minute particles of material during the switching operation.



Check the contact condition

Contact-Breaker Adjustment Fit the new points and check that they fit squarely to one another. Rotate the engine until the heel of the points is on a lobe of a cam. Slacken the retaining screw until it just holds the fixed contact to the base plate. Adjust the fixed contact on the base plate so that the specified size of feeler gauge will pass between the contact points without forcing them apart, whilst touching both sides at the same time.

Dwell Angle Check the dwell angle with the engine running to confirm the correct adjustment of the contact-breaker points gap.

Dynamic Timing The timing is adjusted using a stroboscopic-timing light. The advance mechanism can be checked at the same time. Remove, or leave on, the vacuum pipe in accordance with the manufacturer's specifications.



Worksheet Inspect electronic system primary- and

secondary-circuit components and adjust ignition timing.

Remove the distributor cap and anti-flashover shield to enable inspection of the pulse generator for signs of physical damage. However, it is unusual to find any damage, except when the distributor-spindle bushes are worn. Check the advance mechanism as for primary-circuit components.

Secondary-Circuit Components □□□ The inspection of secondary-circuit components is visual except when a fault is suspected. Look for signs of early deterioration such as a breakdown in electrical insulation leading to shorting of the high voltage to ground. This can occur at any point between the coil and the spark plugs.

HT Leads □□□ Most of the secondary-circuit terminals are a push fit relying on a spring-clamping force between the coil- and plug-wire connectors and the coil, distributor cap and the spark plugs. A loose connection will cause premature wear of the spark plug, a misfire, uneven running or hesitation. These faults can be so slight that they are often difficult to diagnose. Check the resistance of a plug lead with an ohmmeter. Values vary, but 10,000 to 20,000 is a good guide.

Rotor and Cap □□□ Look at the coil top, distributor-cap exterior and interior, and the rotor arm, for signs of cracks, tracking and oil, or water, contamination. Clean these components with a cloth and spray with a water-repellent. Look at these components again with the engine running to see if any visible arcing occurs. Check the condition and security of all the secondary-circuit wires.



Worksheet Inspect, clean, "gap" or renew the spark

plugs.

It is common for the recess where spark plugs fit into the cylinder head to accumulate some dust or particles of fine grit. This should be blown out before removing the spark plugs. Manufacturer's data will specify when plugs should be renewed.

Spark-Plug Threads □□□ Whilst removing the plugs, check that the threads run freely. Clean any threads that are tight because these will affect the tightening torque of the replaced plug.

Spark-Plug Inspection Lay out the plugs in order after removal so that they can be identified with the cylinder for any diagnosis that may be indicated by the plug-tip condition. The condition of the plug tip is a good diagnostic aid for the ignition, fuel and engine condition.



Keep plugs in order when removed for easy inspection

Spark-Plug Faults Check the thickness of the ground electrode, the condition of the centre electrode and insulator nose to see if the plug is reusable. A reduction in the thickness of the earth electrode will allow it to bend in service and open the gap. Burning of the centre electrode may be found. Another reason for replacing the plugs is cracking of the insulator nose, or excessive deposits of carbon compounds on the plug tip and insulator nose, or lead where leaded fuel is used. Always replace plugs at the scheduled service intervals.



Excessive carbon



Contamination



Insulation damage

Setting the Plug Gaps Check and adjust the gap with a wire, or flat, feeler gauge before fitting. Where specified, use a lubricant on the threads. This may be required with some aluminium cylinder-head alloys. Aluminium and steel have a chemical affinity and can become joined by an electrolytic action when they are close together. A graphite, or copper, grease is sometimes recommended, but check the manufacturer's recommendations.



Use a feeler gauge to set plug gaps

Tightening to the Correct Torque □□□ When tightening the plug, use a torque wrench to tighten to the manufacturer's specified torque. If no torque datum is available, tighten the plug finger-tight and then a further 15° for taper-seat plugs and when reusing the washers on flat-seat plugs. For new plugs or washers, turn a further 90°.

Water-Repellent Spray Always ensure that the terminal on the plug is tight, and that the plug wires are a tight fit, and make a good electrical connection. In damp environments, treat the plugs and plug wires with a water-repellent spray.



Look back over the previous section and write out a list of the key bullet points here:

FUEL SYSTEMS

INTRODUCTION

Introduction The fuel-supply systems of petrol-engine vehicles have been extensively developed during the last fifty years. There were many developments in the traditional petrol supply and air mixing methods used in carburettors. However, the Introduction of mechanical and electronic petrol injection systems has made carburettors almost obsolete. Fuel injection is now fitted to all petrol-engine vehicles in order to meet the latest requirements for reducing harmful exhaust gas emissions.

Developments Many of the developments have been introduced to provide improved engine performance with higher power outputs and lower fuel consumption. Meeting environmental protection regulations has been equally important. Diesel fuel pumps and injectors have seen similar developments and the introduction of electronic control of fuel metering and full electronic control systems. Because of these developments, a wide range of fuel systems exists. In this section, the main systems are explained in some detail. The older systems such as carburettors are therefore only examined briefly.

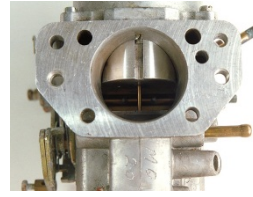

Carburettor



Fuel injection system

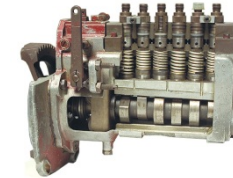

Old diesel pump

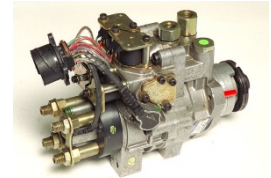

New diesel system

Chemical Action All fuel delivery systems have to supply a quantity of fuel that matches the amount of oxygen that is in the air entering the engine. For petrol engined vehicles, the quantities of hydrogen and carbon in the fuel and the oxygen content of the air should be chemically correct to give a complete chemical change during combustion. The chemical change for clean combustion is $CH + O = CO_2 + H_2O$ or, carbon and hydrogen plus oxygen equals carbon dioxide and water.

Combustion For complete and clean combustion, the ratio of air to fuel should be as close as possible to the stoichiometric value. This is where λ (lambda) equals one. This is a ratio of 14.7:1 by mass of air to fuel. In petrol engines, the optimum for clean combustion is for these quantities to be delivered accurately to each cylinder in the engine. Refer to the 'Engine Mechanical Repair' and the Air Supply, Exhaust and Exhaust Emission Control learning programmes, for additional information on exhaust gas constituents.



Ideal and incomplete combustion

Spark and Compression Ignition Petrol is ignited in the combustion chamber by a spark arcing across the electrode gap of a spark plug. Diesel fuel ignites following injection into the high temperature air charge. The high temperature is obtained by compression of the air charge. The air charge on petrol engines is matched to the amount of fuel delivered. On diesel engines, a full air or gas charge is required in order to raise the temperature by compression.

Compression Ignition On diesel engines, the air charge is not balanced to the fuel delivered and this gives, under most conditions, a surplus of oxygen. This surplus of oxygen can combine with chemicals in the cylinder to form harmful gases such as nitrogen oxides. However, the use of exhaust gas recirculation (EGR) can keep the surplus oxygen to a minimum. The mix of air and exhaust gas helps to reduce the production of nitrogen oxides.

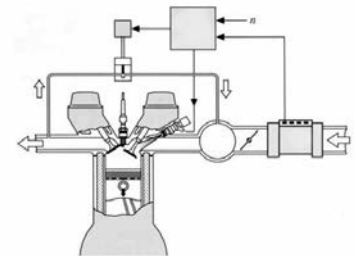

Exhaust gas recirculation

Exhaust Gas The carbon dioxide and water in the exhaust are not directly harmful. Carbon dioxide is a greenhouse gas and is believed to contribute to global warming. Exhaust gases are not normally clean, as internal engine combustion is not a simple process. This makes the use of catalytic converters essential.

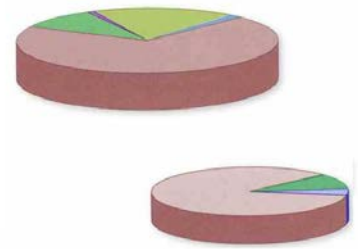

Exhaust gas constituents

Catalytic Converters Catalytic converters help to change any residual fuel, carbon monoxide or nitrogen oxides to harmless substances. The fuel may have impurities or additives to aid combustion, which is the case with leaded fuel. There are other gases in the air, which also undergo chemical reaction during the burning of the fuel in the engine. Poor distribution of the fuel in the air charge will give local variations in the combustion process and harmful exhaust gas constituents.

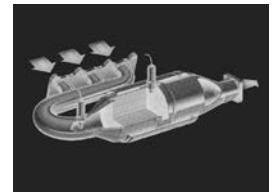

Action of catalytic converters

Fuel Additives The impurities and additives have been considerably reduced over recent years. The most significant impurity was low quantities of sulphur, which combines with atmospheric gases to form sulphuric acid. Leaded petrol has tetraethyl lead added as an octane enhancer. This additive was used to prevent knocking by slowing the combustion process to a specific value. However, lead is a substance that is damaging to people's health and is being phased out of petrol in favour of other chemicals, which can perform the same task.

Octane Rating The rate of combustion of petrol is a measurable value. Octane is the fuel that is used as a comparative for all petrol fuels. The combustion characteristics of octane are given a value of 100. This value is then used to measure other petrol fuels. The octane rating of a fuel is used to set, among other things, the engine compression ratio and ignition timing at the design stage. It is then used in service as a guide for the fuel that should be used. Typical petrol octane ratings are 93 and 97. The equivalent substance for diesel fuels is cetane and typical cetane ratings are 48 to 50.

Fuel Additives Fuel additives for petrol and diesel include substances that will prevent or reduce some of the harmful effects of raw fuel. Examples are, gum and tar formation and the corrosion of components. Antifreeze is added to petrol for very cold climates and to diesel for all conditions where temperatures fall below freezing. Diesel fuel contains paraffin, which forms a wax at cold temperatures. This wax prevents the fuel from flowing. All winter grade diesel fuel contains additives to provide protection for the area in which it is sold.

Fuel Supply The fuel on the vehicle is held in a tank fitted in a safe position. Recent construction legislation requires that the tank is unlikely to be ruptured in a vehicle collision. The positioning and protection of the tank is considered at the design stage of the vehicle and tested during development. The tank is fitted with a filler neck and pipe work from the filler cap to the tank. Also fitted are the outlets to the atmospheric vent or evaporative canister and the fuel feed and return pipes to the engine. The fuel gauge is located in the fuel tank. Fuel supply and return lines are made from steel pipes, plastic pipes and flexible rubber joining hoses depending on application and the type of fuel used.

Fuel Pumps A pump to supply fuel to the engine is fitted into or near to the tank on petrol injection vehicles. On carburettor vehicles, a mechanical lift pump is fitted to the engine and is operated by a cam on the camshaft or crankshaft, or an electric pump is fitted in the engine compartment. Diesel engined vehicles using a rotary fuel injection pump, may use the injection pump to lift fuel from the tank. Alternatively, they may have a separate lift pump similar to the ones used on carburettor engines. A separate priming pump fitted in the fuel line may also be used.



Mechanical fuel pump



Electric fuel pump in the line





Electric fuel pump in the tank



Diesel primer pump

Mechanical Lift Pump This diagram shows the operation of a typical mechanical fuel lift pump. Refer to vehicle manuals for details of specific fuel pumps. Modern pumps are sealed units and have to be replaced as a complete unit if they become defective.

 Explain what is meant by complete and incomplete combustion.

 Look back over the previous section and write out a list of the key bullet points here:

CARBURETTORS (OPTIONAL)

Carburettor The carburettor was the traditional method of mixing petrol with air as it enters the engine. However, a simple carburettor is only capable of providing a correct air and fuel mixture ratio within a very small engine speed range. For road vehicles a wide engine speed range and a wide engine load is required. In order to respond to the speed and load variations complex carburettors are used.



Single choke and twin choke carburettor

Basic Carburettor Designs There are two basic carburettor designs, the fixed venturi and the variable venturi types. The term choke is often used to describe the venturi and this gives the alternative carburettor definitions of fixed choke and variable choke types. The usual meaning of the term choke is to describe the engine cold start device fitted to the carburettor.



Fixed choke and variable choke carburettor

Function of the Carburettor □□□ The function of the carburettor is to meter a quantity of petrol into the air stream entering the engine cylinders. As the pistons move down in the cylinders on the induction stroke the pressure in the space above the cylinders falls. On naturally aspirated engines, that is, those that are not fitted with pressure chargers, atmospheric pressure provides the force for the air flow into the cylinders.

Throttle The greater the difference in pressure, the greater will be the volume of air that enters the engine and the speed of the air flow through the carburettor and inlet manifold. A valve to meter the air flow is fitted at the base of the carburettor just in front of the inlet manifold. This valve is called the throttle and it consists of a round plate on a spindle. The spindle has a lever attached to one end and this is connected directly to the throttle pedal with a cable or rods. The throttle restricts the air flow in all positions except when wide open and this gives a range of variable pressures in the carburettor and the inlet manifold.

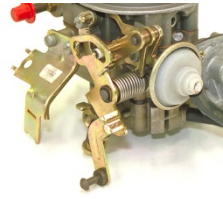

Throttle linkage

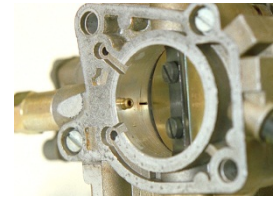

Throttle butterfly

Carburettor Design It is the variations or changes in air pressure and air speed that are used in modern carburettors to control the amount of fuel that is metered into the engine. The developments in carburettor designs give more accurate metering of fuel to air across the range of engine speed and load conditions. However, the very close tolerances required by the environmental protection regulations and the advances in microelectronics have contributed to a reduction in use of the carburettor.

Fixed and Variable Venturi Carburettors This learning programme describes the principles of the two types of carburettor, the fixed and variable venturi types and some of the latest developments to meet environmental protection regulations. Individual carburettors fitted to vehicles all operate to the same basic principles. There is a wide range of manufacturers and variations to the basic types. For information on particular carburettors, reference should be made to manufacturer's technical data.

Fixed Venturi Carburettors This picture shows a single fixed venturi carburettor and the external details of the main parts. The carburettor body splits across the top of the float chamber and some of the internal parts can be seen.



Single venturi carburettor

Carburettor Operation A working diagram of the carburettor is shown here with the main parts labelled. To understand the functions of the parts of the carburettor, it is necessary to know the particular conditions existing in the air flow through the carburettor. In particular, the speed and load conditions in the engine are important. As the air flow is closely related to the engine speed and load conditions, these are used to understand the technical features of the carburettor.

Fuelling Requirements □□□ There are six clearly identifiable engine and vehicle use conditions. These are: cold starting, idle, progression, acceleration, cruising and full load. As cruising is the expected main condition of vehicle use, the carburettor venturi size is selected by manufacturers to suit that condition. Internally, fuel and air jets are matched to the venturi size and air flow characteristics to give accurate metering of the fuel into the air flow. Added to this basic design are other devices to meet the range of operating conditions.

The Basic Carburettor The basic carburettor consists of the venturi, through which the air flows, and the float chamber which holds a supply of petrol at a constant level in relation to the supply beak in the venturi. The level of petrol in the float chamber is maintained by a needle valve that is lifted onto its seat by the float so that it stops the flow when the chamber is full. As petrol is used the level drops, the needle valve opens and the flow of petrol into the chamber resumes. In this way, a constant petrol level is maintained. The float level should be checked and adjusted if necessary, if problems occur or if the carburettor is stripped for cleaning.

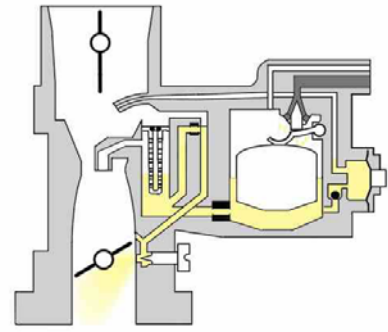

Fuel level is control by a float and needle valve

Main Jet The main jet in the fuel feed to the venturi forms a restriction in the petrol flow and by virtue of its size acts as a metering device. The venturi is a tube with an inward curving restriction. Air flow through the venturi speeds up as it passes through the restriction. The effect of this is to reduce the air pressure at that point. Inside the float chamber, atmospheric pressure is applied to the top of the petrol held there. A vent in the top of the float chamber allows a free passage of air and atmospheric pressure.

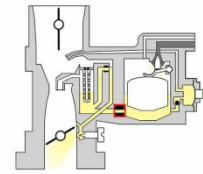

Main jet in the fuel feed to the venturi

Venturi A pressure differential exists at each end of the fuel supply tube between the float chamber and the venturi supply beak, when there is sufficient air flow to create a vacuum in the venturi. It is this pressure differential that is used to lift petrol up to the beak. From here, it passes into the air stream through the venturi and into the engine cylinders.

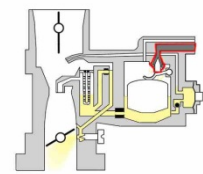

Pressure differential lifts fuel up to the supply beak

Compensation Devices Although there is an increase in fuel delivery with an increase in air flow, these do not match sufficiently to maintain the correct air and fuel ratio over the full operating range. Other devices are needed to adjust the metering of petrol to the correct ratios. These are explained later in this section. The venturi can be positioned vertically with the air flow being downward or upward or it can be positioned horizontally. This gives the expressions down draft, up draft and side draft for descriptions of carburettors.

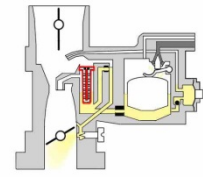

Emulsion tube

Engine Idle On this carburettor, the devices for engine idle or tick over can be seen. The air flow through the venturi restriction is insufficient at idle speeds to give the pressure differential requirement for petrol flow into the venturi at the supply beak. The idle device is required to supply the low quantity of fuel needed at engine idle speeds.

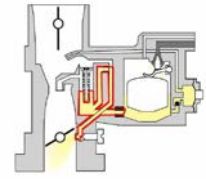

Idle circuit

The vacuum in the inlet manifold is high when the throttle plate is closed. This vacuum is used in the idle device to create a flow of petrol and air through jets and drillings in the carburettor body. The petrol and air mixture enters the air intake through the idle port just below the throttle plate. The size of the pilot petrol jet and adjustment of the air flow provides a suitable air to fuel ratio for engine idle operation.

Solenoid Valve It is possible for the residual vacuum in the inlet manifold, when the engine is stopped, to continue to draw petrol into the engine and in some cases engine run-on or 'dieseling' will occur. On carburettors where this is likely to occur, an electric solenoid valve is fitted. This solenoid is energised when the ignition is on to open the idle port drillings. When the ignition is turned off the solenoid valve closes to prevent fuel flow.



Anti-dieseling solenoid

Progression Progression is used to describe the increase in engine speed, from idle, up to the point where the venturi and main jet come into operation. At idle speeds, the air flow through the venturi is not enough to provide a suitable pressure differential. Normal venturi mixing of petrol in the air stream flowing into the engine is therefore, not possible. Additional drillings in the lower part of the venturi, just above the throttle plate, connect to the float chamber. This allows an extra fuel supply during this phase. There are some variations in the number and routing of these drillings, but they all provide for a smooth response to initial acceleration from idle.

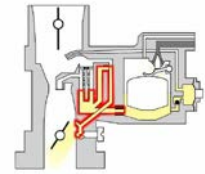

Progression air and fuel paths

Cruising The cruising speed range is wide and covers most operating conditions from light cruising up to a position just below full throttle. Petrol is drawn from the float chamber into the air stream passing into the engine. The supply beak design and position, gives good atomisation and distribution of the fuel in the air flow. The air fuel ratio in a simple venturi becomes richer with an increase in engine speed. In order to maintain the correct ratio mixture correction devices are used. It is also desirable for the engine to run on a lean mixture when the vehicle is cruising. Many carburettors have additional air bleed devices to weaken the air fuel ratio when cruising.

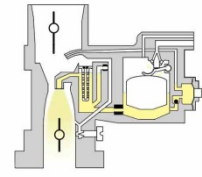

Emulsion tube

Full Load Carburetors were designed to meet full throttle conditions without additional devices being fitted. However, these designs were unable to meet tougher environmental regulations, which required accurate control of exhaust emissions. The development of twin choke progressive carburetors, is a way by which designers have tackled the problems of maintaining correct mixture strengths, over the full range of engine operating conditions. The primary venturi works at the low throttle positions and the secondary venturi is added at the higher throttle positions.



Twin choke carburettor

Acceleration If rapid acceleration is demanded, the vacuum in the venturi is lost for an instant when the throttle is opened quickly. The petrol flow through the supply beak from the float chamber cuts off and without a supplementary supply; a 'flat spot' would be experienced. To prevent flat spots on acceleration, an accelerator pump and petrol discharge nozzle are fitted. The pump consists of a piston or diaphragm, a one-way valve, and drillings for a petrol supply from the float chamber. The pump is connected by a rod or cam linkage to the throttle plate lever. This causes a pulse of petrol to be sprayed into the venturi when rapid opening of the throttle is made.

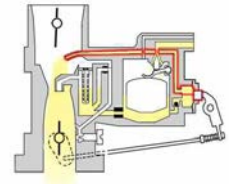

Accelerator pump and jet

Cold Start and Warm Up Cold start and warm up conditions require a rich mixture. This is to keep the engine running smoothly and allow a smooth acceleration response. A cold engine with a normal mixture ratio is likely to cut out.

Uneven running, even if the engine speed were increased, would result. The mixture ratio for starting a very cold engine can be as low as 4:1. This ratio increases as the engine temperature increases, so that by the time the engine is at normal operating temperature, a correct ratio can be used. This requires additional devices on the carburettor, to provide an initial low ratio (rich mixture), and then to progressively increase the ratio as the engine warms up.

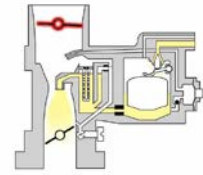

Choke operation

Enrichment Devices Cold start enrichment devices on fixed venturi carburettors use a choke plate at the top of the venturi. This lifts engine vacuum higher into the carburettor. A manual choke plate is a flap fitted to an offset spindle, which is rotated to the on position by a spring when the choke is applied. The choke is held in the partial, and off positions, by a cam connected to the choke cable.

Fast Idle There is usually a linkage between the choke plate lever and the throttle, to increase the engine speed. This increase in speed is called fast idle. This is an important setting for correct 'cold engine' operation. The fast idle connection from the cold start device, or choke as it is often called, is usually made by a rod and a cam between the cold start device and the throttle plate lever.

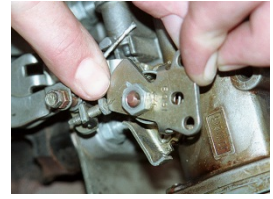

Fast idle mechanism

Cold Start Device The cold start device may be operated by a simple cable link for driver control. However, on vehicles subject to exhaust emission regulations, an automatic device is used. This gives a progressive release of the choke as the engine warms up. An automatic device that has been in use for some time is a bimetal thermostatic spring. This closes the choke plate when cold and then progressively opens the flap as the engine warms up. Stepper motors are also used.

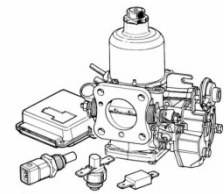

A stepper motor controls the choke

Additional Carburettor Devices Some carburettors may be fitted with a hot idle compensator. This is an air bleed system that will raise the engine idle speed when the engine is hot. This increase in engine speed improves coolant circulation and engine cooling and helps to reduce fuel vaporisation and the emission of unburnt hydrocarbons. The hot idle compensator air bleed is controlled by a bimetal strip valve in a drilling in the carburettor body. The drilling allows a supplementary flow of air to bypass the throttle plate when the carburettor temperature is sufficiently high.



Hot idle compensator

Deceleration Device A deceleration device may be used to slow the engine speed drop off when the throttle pedal is released. This is a damper usually called a dashpot, which has a diaphragm at the centre and a small air bleed hole to regulate the throttle closing rate. It is fitted so that an extension from the throttle spindle contacts the diaphragm push rod. The throttle pull off spring exerts a force on the diaphragm, air is expelled from the dashpot, and the throttle is closed slowly. This helps to reduce unburnt hydrocarbons (petrol and engine oil vapour) during deceleration.

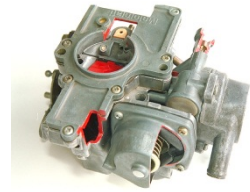

Deceleration damper

Multiple Venturi Carburetors The venturi on a carburettor can also be called a choke or a barrel. This term gives the descriptions of multiple venturi carburetors as twin choke or two barrel. There are two types of multiple carburetors. These are the progressive and compound types. A progressive carburettor has two venturis working as one carburettor. The primary venturi operates during low engine speed and load conditions. The secondary venturi comes into operation as the engine speed and load increases. The secondary venturi may be opened by a mechanical link from the primary throttle spindle lever. In some cases, a vacuum motor sensing engine load conditions is used.



Twin choke
progressive
carburettor

Variable Venturi Carburettors □□□ Variable venturi (VV) carburettors are also known as constant depression types. This is because the variation in the venturi size maintains a relatively even depression or vacuum, in the restricted zone. This is the position where petrol is drawn into the venturi from the float chamber. The restriction in the venturi is made up from a fixed ledge and a moving piston. The moving piston is opened by the vacuum on the engine side of the restriction, and the position of the throttle plate. The vacuum is applied to either the piston or a diaphragm assembly. This in turn regulates the size of the venturi.

Metering Needle □□□ To meter the petrol into the air flow the petrol main jet is positioned close to the venturi restriction. A tapered needle fitted to the moving piston locates in the bore of the main jet. As the venturi opens, the needle moves out of the main jet. The reducing size of the tapered metering needle allows an increased flow of petrol to suit the increased amount of air passing through the venturi. In this way, a variable venturi carburettor can cope with all operating conditions from idle, through cruising to wide open throttle positions.

Cold Start and Warm Up □□□ For cold start and warm up, the jet is lowered so that the taper on the needle allows an increased petrol flow. This gives the enrichment needed for cold starting. The throttle is partially opened to the fast idle position by a link from the choke lever, which is used to pull the jet down.

Acceleration Acceleration also requires an additional device. This is provided by damping the opening of the venturi when the throttle is rapidly opened. The damping is provided by an oil filled dashpot above the venturi piston. The oil flow past the dashpot valve restricts the rate at which the venturi opens. This creates an increase in air flow through the restriction and a lower pressure. This in turn means that more petrol is delivered so that the mixture strength increases. A flat spot during acceleration will therefore be presented.





Acceleration device - dash pot

Down Draft Variable Venturi Down draft variable venturi (VV) carburetors, use an auxiliary idle jet device. This is similar to those used on fixed venturi types for cold start and idle speed enrichment. These carburetors have a vacuum operated accelerator pump to enrich the mixture following rapid opening of the throttle plate.



Ford VV
carburettor

 Explain why a variable venturi carburettor can also be described as constant depression.

 Look back over the previous section and write out a list of the key bullet points here:

Electronic Fuel Injection (EFI) Systems

Electronic petrol injection systems have been in use for many years, first on expensive and sports vehicles and now standard equipment on most vehicles. The tougher standards of exhaust emission regulations have made the use of microelectronic control systems for fuel delivery a virtual necessity. There are many different manufacturers of electronic fuel systems and this programme covers the main points of the systems.



EFI system

Electronic Control Unit At the heart of electronic fuel injection (EFI) systems is the fuel control or electronic control unit (ECU) with a stored map of operating conditions. Electronic sensors provide data to the microprocessor in the ECU, which calculates, and sends the output signals to the system actuators, which are the fuel pump, fuel injectors and idle air control units. The ECU will also switch some of the exhaust emission and auxiliary system components.

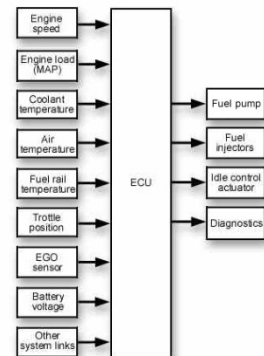

ECU with inputs and outputs

Fuel Injection Methods □□□ Electronic fuel injection (EFI) systems are named by the position and operation of the fuel injectors. There is a range of throttle body injection (TBI) systems. They are also known as single point (SPI) or central point (CPI) systems. However they are named, the injector is positioned in a housing fitted on the inlet manifold. This is the same position as the carburettor was traditionally fitted.

Simultaneous and Sequential Injection The port fuel injection (PFI) or multi-point (MFI) systems have individual injectors for each cylinder. The injectors are fitted so that fuel is sprayed into the inlet ports. Port fuel injection systems are either simultaneous, where all injectors operate at the same time, or sequential, where each injector operates on the induction stroke for each cylinder in turn.

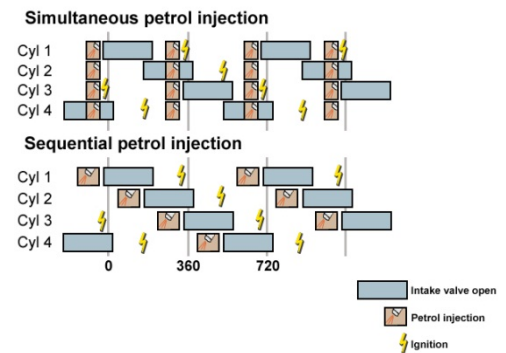

Types of fuel injection systems

Gasoline Direct Injection (GDi) A recent development has been the Introduction of a direct injection petrol engine where the fuel is injected into the combustion chamber.



Mitsubishi GDi

Engine Control Module Modern petrol injection systems are linked to the ignition systems and are controlled by an engine control module (ECM). The latest developments have all electronic systems linked to form a power train control module (PCM). This is also described as a vehicle control module (VCM). All modern fuel injection systems have closed loop electronic control using an exhaust gas oxygen sensor. For clarity, each electronic control unit will be referred to as an ECU.

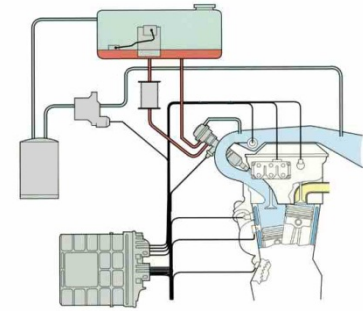

Ignition and fuel systems are combined

Inputs and Outputs The components for any electronic fuel injection system can be divided into four groups: The air supply components, the fuel supply components, the electronic control unit (ECU), together with the power supply and system harness and the sensors which provide data to the ECU.

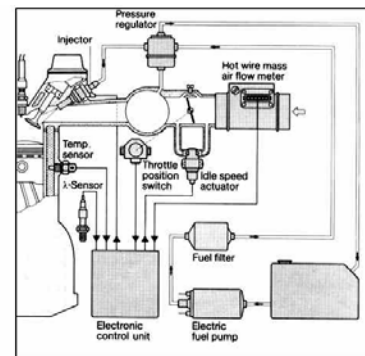

Efi components

Air Supply Components The air supply components consist of ducting and silencing components between the air intake and the inlet manifolds. This will also include an air filter, a throttle body, throttle plate assembly and idle control components. The air supply components must provide sufficient clean air for all operating conditions. The air flow into the engine would be noisy and unbalanced between cylinders without the use of resonators and plenum chambers. A plenum chamber is a large volume air chamber that can be fitted either in front of or behind the throttle plate housing.

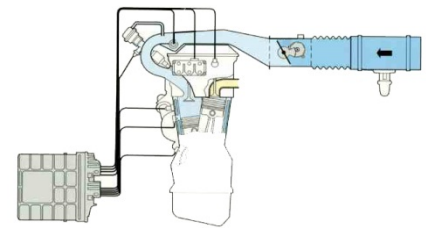

Air supply

Air Filter Air filters on most modern petrol engined vehicles consist of a plastic casing with a paper filter element. Air flow into the filter is upwards so that dust and dirt particles drop into the dust chamber, or is rotary so that dust and dirt is thrown out before the air enters the engine. Crankcase ventilation and the air supply or pulse air exhaust emission systems, are also connected to the filter assembly.



Air filter on a modern vehicle

Throttle Body The throttle is a conventional circular plate in an air tube. For fast idle and warm up, an auxiliary air valve is fitted to bypass the throttle plate, or an electromechanical link is made to the throttle plate spindle. An auxiliary air valve, idle air control valve (IAC) or idle speed control valve (ISC) is operated from signals from the ECU.



Throttle body assembly

Auxiliary Air Valve □□□ Early designs of the auxiliary air valve use a disc with a calibrated aperture for closing or opening the bypass air channel. The disc is held closed by a pull off spring and opened by a bimetal spring. When the engine is cold, the bimetal spring bends to open the valve. With the engine running, an electrical heating current acts on the bimetal strip. This causes it to bend and allow the pull off spring to close the air channel.

Rotary Air Valve □□□ A later development of the auxiliary air valve is the rotary air valve. This has a special electric motor to move and hold the valve in position. The position is based on the electrical signals supplied by the ECU. Two electric windings in the motor work in opposition to each other so that the motor is variable over a 90° arc.

Solenoid Valve Other designs of auxiliary or 'extra air' valves have graduated opening values based on the strength of current supplied from the ECU. These valves operate to hold the idle speed to the stored data specification for engine temperature and load conditions. The valve consists of a solenoid valve with a spring-loaded armature connected to the valve in the air channel.



Solenoid air valve

Air Bypass □□□ The amount of air allowed to flow through the bypass channel of the auxiliary air valve is regulated by the position of the valve. At idle, the valve is continuously adjusted to stabilise the speed. When the throttle is closed during deceleration the valve plate is adjusted to control exhaust emissions. During engine starting, the valve is open and when the engine is switched off the valve is in the rest position.

Idle Speed Control Idle speed control can also be provided by direct action onto the throttle spindle. Electric solenoids or stepper motors are used for this method of control. The solenoids can be single position or multi-position types and can be used for not only cold start and warm up control but also to open the throttle when high load systems, such as the air conditioner, are switched on. Stepper motors give graduated positions depending on the supply current to a number of electric windings. Sensors in the idle control mechanisms provide feedback signals to the ECU to provide data on operation and position.

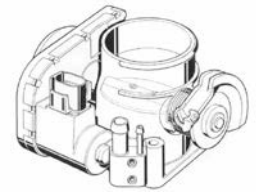

Throttle idle speed control

Fuel Supply The fuel supply from the fuel tank to the injector valves for all electronic systems follows the same basic layout. The delivery of fuel at the injector valves is also based on a similar function for all systems. A basic layout of fuel supply components is shown here. A fuel pump is fitted either in, or close to, the fuel tank. A fuel filter is fitted in the delivery fuel lines from the tank to the fuel rail. A fuel pressure regulator is fitted on either the housing for throttle body injector systems, or the fuel rail for port fuel injection systems. The return fuel lines run from the pressure regulator to the fuel tank.

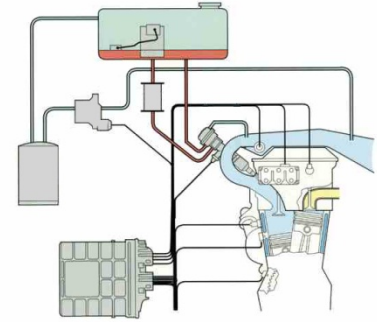

Fuel supply components

Fuel Pump The fuel pump is a roller cell pump driven by a permanent magnet electric motor. Fuel flows through the pump and motor but there is no risk of fire as there is never an ignitable mixture in the motor. The delivery pressure is set by a pressure relief valve, which allows fuel to return to the inlet side of the pump, when the operating pressure is reached. There is a non-return valve in the pump outlet. Typical delivery pressures are between 300 and 400 kPa (3 to 4 bar).

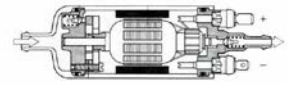

Roller cell pump

Roller Cell Pump □□□ The rollers in the roller cell pump are thrown out by centrifugal force when the motor armature and pump rotor spindle rotate. The rotor is fitted eccentrically to the pump body and as the rollers seal against the outer circumference, they create chambers that increase in volume to draw fuel in. They then carry the fuel around and finally discharge it as the chamber volume decreases.

Pump Electrical Supply The fuel pump electrical supply is live only when the engine is being cranked for starting or is running. The fuel pump electric feed is from a relay that is switched on with the ignition. Safety features are built into the electric control feed to the relay so that it operates only to initially prime the system or when the engine is running. The control functions of the fuel pump relay are usually provided by the fuel control module.

Inertia Switch A further safety feature is the use of an inertia switch in the feed from the relay to the fuel pump. This operates, in the event of an accident, to cut the electric feed to the fuel pump and to stop the fuel supply. It is an impact operated switch with a weight that is thrown aside to break the switch contacts. Once the switch has been operated it has to be manually reset.

Fuel Filters The fuel filter is an in-line paper element type that is replaced at scheduled service intervals. The filter uses micro-porous paper that is directional for filtration. Filters are marked for fuel flow with an arrow on the casing and correct fitting is essential.



An in-line paper element type

Fuel Pressure Regulation The fuel pressure regulator is fitted to maintain a precise pressure at the fuel injector valve nozzles. On port fuel injection systems, a fuel rail is used to hold the pressure regulator and the fuel feed to the injector valves. The injector valves usually fit directly onto or into the fuel rail. The fuel rail holds sufficient fuel to dampen fuel pressure fluctuations and keep the pressure applied at all injector nozzles at a similar level.



Fuel pressure regulators on rail...



And on throttle body

Operation of the Fuel Pressure Regulator Fuel regulators are sealed units with a spring-loaded diaphragm and valve on the return outlet to the fuel tank. Fuel is pumped into the regulator and when the pressure is high enough, it acts against the diaphragm and compression spring to open the valve. Surplus pressure and fuel is allowed to return to the fuel tank. Once the pressure in the fuel regulator is reduced, the valve closes and the pressure builds up again. Throttle body injection systems operate in the region of 1 bar, and port fuel injection systems in the region of 2.5 bar.

Inlet Manifold Vacuum □□□ On port fuel injection systems, inlet manifold vacuum acts against the compression spring in the fuel pressure regulator. This is required in order to maintain a constant pressure differential between the fuel rail and the inlet manifold. With a constant pressure differential, the amount of fuel delivered during a set time will be the same irrespective of inlet manifold pressure.

Turbocharger □□□ For vehicles fitted with a turbocharger or supercharger, inlet manifold pressure is applied to the diaphragm and regulator valve. When the inlet manifold pressure rises above a certain value, the regulator valve is closed so that the full pump delivery pressure is applied to the injector valve nozzles. This raises the amount of fuel delivered to match the boosted air charge.

Injector Valves The injector valves spray finely atomised fuel into the throttle body or inlet ports depending on the system. The electromagnetic injection valves are actuated by signals from the ECU. The signals are of a precise duration depending on operating conditions but within the range of about 1.5 to 10 milliseconds. This open phase of the injector valve is known as the 'injector pulse width'.

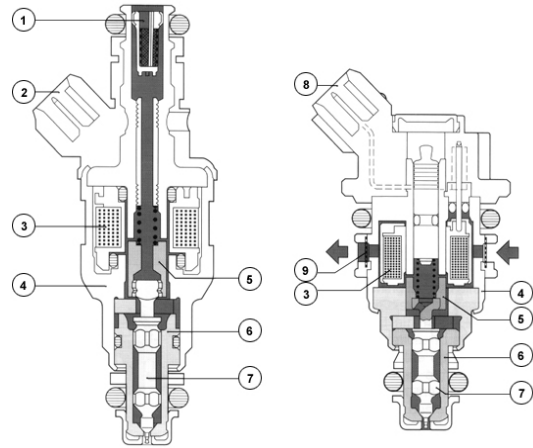

Solenoid Injectors □□□ There is a range of individual injector valve designs but all have the same common features. These are an electromagnetic solenoid, with a spring-loaded plunger, connected to a jet needle in the injector valve nozzle. The electrical supply to the solenoid is made from the system relay or ECU. Earthing or grounding the other connection energises the solenoid. This lifts the plunger and jet needle so that fuel is injected for the duration that the electric current remains live. As soon as the electrical supply is switched off in the ECU, a compression spring in the injector valve acts on the solenoid plunger to close the nozzle.

Throttle Body Injector A fuel injector valve for a throttle body system is shown here. This cross section view shows the housing, the magnetic coil for the electric solenoid and the jet needle and nozzle.

Multi-point Injector A top feed fuel injector valve for port fuel injection systems is shown here. This type of valve is generally used on earlier systems. One problem experienced with this fuel feed arrangement is fuel vaporisation and bubbles forming in the fuel rail. The bubbles can cause starting and running problems. To overcome this problem lateral or side or bottom feed injectors are used. An example of this type is shown here. When fitted in the fuel rail it can be seen that any bubbles that may form will be at the top of the rail. They will therefore, be flushed out through the regulator as soon as the fuel pump is actuated.

Cold Start Injector Valve with a Thermo-Time Switch Early electronic fuel injection systems used a cold start injector valve with a thermo-time switch control circuit. The cold start injector valve is an electromagnetic solenoid valve. It is energised during starter motor operation but subject to the condition of the thermo-time switch. The cold start injector valve operates only when the engine is cold and for a maximum time of about ten seconds (when the ambient temperature is below -20°C). The time progressively shortens above this temperature. Later electronic fuel injection systems have the cold start enrichment calculated in the ECU. The pulse width of the fuel injector valves is increased to provide the extra fuel needed during start up.

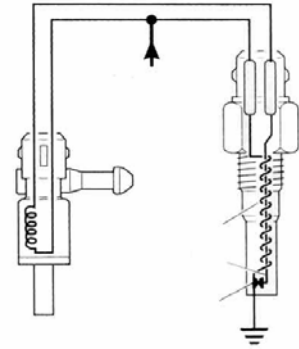

Cold start injector and circuit

Electronic Control Unit (ECU) The electronic control unit is an electronic microcomputer with a central processing unit (CPU) or microprocessor. Inside the CPU are software programs that compare all sensor input data with a fixed map of operating conditions. It then calculates the required output signal values for the injection valves and other actuators. A computer program that demonstrates the operation of a fuel ECU and system is available from the automotive technology website.



Inside an ECU

ROM and RAM The fixed map of operating conditions specific for each engine is held in a fixed value memory or read only memory (ROM). The operating data store of input values from the sensors is held in a random access memory (RAM). A 'keep alive' memory (KAM) of specific data such as adjustments, faults and deviations in component performance may also be used. The RAM data is erased when the ignition is switched off. The KAM data is erased when the battery is disconnected. New data is replaced in the RAM and KAM during engine start up and operation.

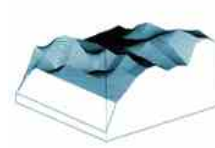

Fuel map

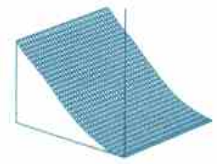

Transition map

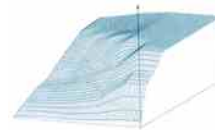

Dwell map



Injection map

Cold Start and Warm Up Phases

During the cold start and warm up phases of engine operation the computer operates in an open loop mode based on the sensor data. Once the engine reaches a certain temperature and the signals from the exhaust gas oxygen (or Lambda) sensor are logical, the computer operates in a closed loop mode based on the data from this sensor.

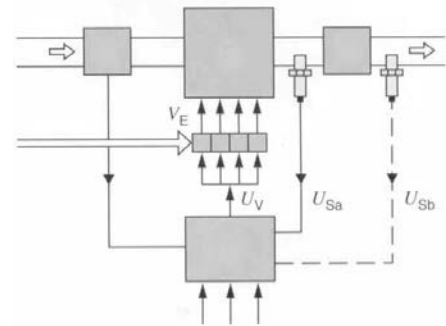

Closed loop control with lambda sensor

CPU Operation Other programs in the CPU monitor the system and sensor data. They provide fault diagnosis and limp-home or a limited operation strategy in the event of any defects being detected. Other components in the ECU provide signal amplification and pulse shaping. This includes analogue to digital (A/D) converters for DC voltages, and pulse formers for AC voltages. The CPU requires digital signals for all processing functions. On the output side, power transistors are used for switching the actuator supply voltages either to the components or to an earth or ground point.

Emission Control The ECU also operates the emission control components at appropriate times depending on the engine operating conditions. Typical emission control actuators are the canister purge solenoid valve, the exhaust gas recirculation (EGR) valve and the secondary air solenoid valve.

Secondary air is provided by either the air injection reactive or pulse air systems.

Electrical Harness The electrical harness for the engine management system is a complex set of cables and sockets. Cables have colour and/or numerical coding and the sockets are keyed so that they can be connected in one way only.

Special low resistance connectors are used for low current sensor wiring. Follow manufacturer's data sheets for further technical detail.

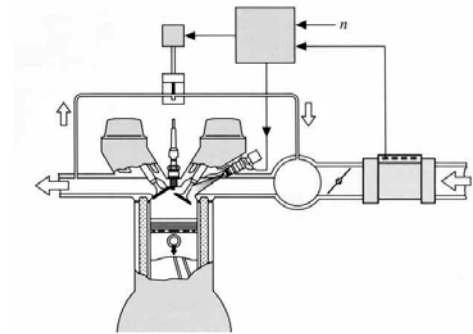

EGR system

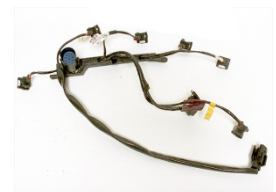

Injection wiring harness

Sensors Sensors provide data to the ECU. The engine speed and load conditions are used to calculate the base time value (in milliseconds), for the injector pulse width. A range of correction factors are added to or subtracted from the base time value to suit the engine operating conditions occurring at all instances of time.

 Calculation of injection time

Engine Speed and Position On early electronic fuel injection systems, the engine speed was provided from signals obtained from the ignition low tension primary circuit. On engine management systems, the engine speed and position is required for the ignition and fuel systems.



Inductive speed sensor

Continuous Injection Systems On continuous injection systems, the fuel is injected on the induction strokes when one of the inlet valves is open. On the other stroke, fuel is injected into the inlet port where it remains until the valve opens. On sequential systems, a single fuel charge is injected during the inlet valve open stage. Accurate engine speed and position sensing is required for this to occur correctly.

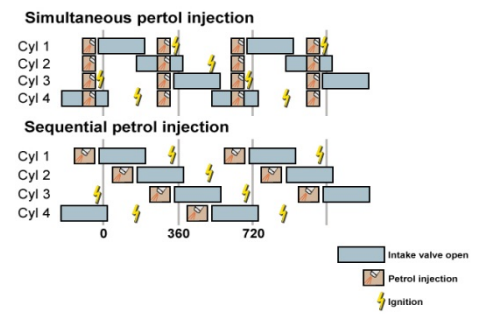

Injection process

Methods of Engine Speed and Position Sensing

There are two methods of engine speed and position sensing. The older system is a conventionally geared distributor with an inductive or Hall effect generator. This provides an alternating signal current that is used by the ignition system. It is also used for engine speed sensing in the fuel electronic control module.



Distributor for engine speed and position sensing

Inductive Pulse Generators Most of the latest systems have inductive pulse generators mounted close to, and responding to, a toothed wheel attached to the crankshaft pulley or flywheel. There is an air gap between the toothed wheel and the inductive generator and as the teeth pass the inductive generator, an alternating electric current is produced. The waves of the alternating current are used to measure engine speed. For position sensing, a missing or different size of tooth or mask opening on the sensor ring is used. A distributor can also provide a reference for number one cylinder at top dead centre. When a sensor is fitted to determine the crankshaft position, this is suitable for continuous injection systems.

Sequential Injection For sequential injection, a camshaft position sensor or phase sensor in the distributor is used to recognise the position of number one cylinder. The ECU is then able to follow the engine firing order.



Camshaft position sensor

AC Voltage Pulse Inductive sensors produce an output pulse each time a lobe or tooth passes the inductive coil. The frequency and pattern of the pulses is used by the ECU to determine the engine speed and position.

Air Flow Meter □□□ The fuel requirement is calculated in the ECU from the engine speed and load conditions. An air flow meter is one method of measuring the engine load conditions. A variable voltage, corresponding to the measured value at the air flow meter, is used by the ECU to calculate the amount of fuel needed to give a correct air/fuel ratio.

Engine Load Engine load can also be determined from the inlet manifold absolute pressure (MAP) and this is used on some systems to provide the data. In these systems, an air flow meter is not used.

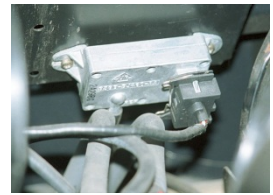

MAP sensor

Air Flow Metering There are two main types of air flow meter. These are the vane type (VAF) and the resistive types (MAF). The vane type air flow meter consists of an air passage and damping chamber into which is fitted a fixed pair of flaps (or vanes), which rotate on a spring-loaded spindle. The spindle connects to and operates a potentiometer and switches.



Vane type air flow meter

Flap Type Air Flow Meter Air flow through the meter acts on the intake air flap to move it in opposition to the spring force. The integral damper flap moves into the sealed damper chamber to smooth out the intake pulses. The degree of flap movement and spindle rotation is measurable at the potentiometer as a variable voltage dependent on position. The voltage signal, together with other signals, is used in the ECU to calculate the fuel requirement.

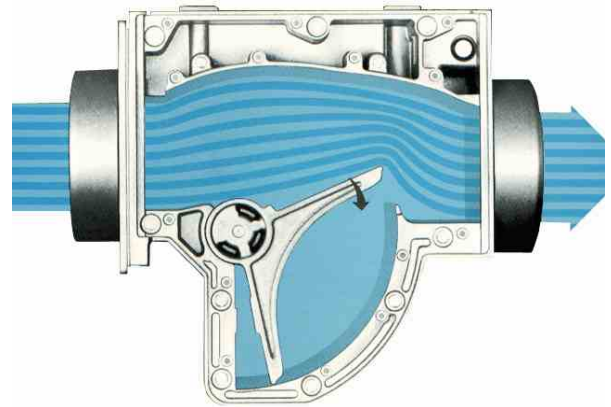

Action of the vane air flow meter

Bypass Air Duct A bypass air duct is built into the housing. This provides for starting without opening the throttle, a smooth air flow during engine idle and a means to adjust the idle mixture.

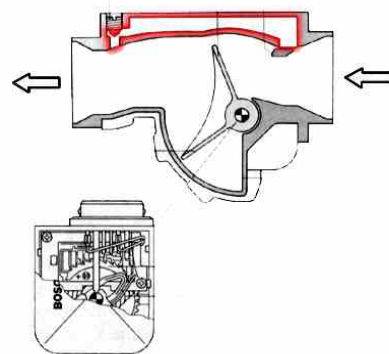

Air bypass

Mass Air Flow Meters Mass air flow meters are fitted with two similar resistors inside an air tube. A measurement resistor is heated and often referred to as a hot wire. The other resistor is not heated. It provides a reference value for use in the calculation of the air mass. The control circuit maintains the temperature differential between the two resistors. The signal sent to the ECU is proportional to the current required to heat the measurement resistor and maintain the temperature differential. The output signal from some mass air flow meters is similar to the air vane types. However, some produce a digital output signal.

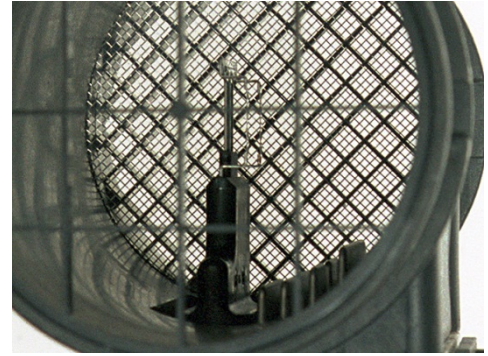

Hot wire/film air flow meter

Manifold Absolute Pressure Sensor On some EFI systems manifold absolute pressure (MAP) sensor signals are used by the ECU to calculate the fuel requirements. These systems do not have an air flow meter. The signals from manifold absolute pressure, engine speed, air charge temperature and throttle position, are compared in the ECU to calculate the injector pulse width.

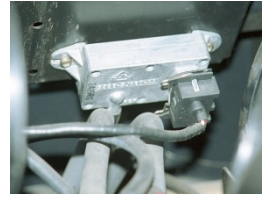

MAP sensor



Crank sensor

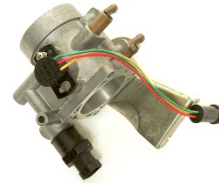

Throttle potentiometer

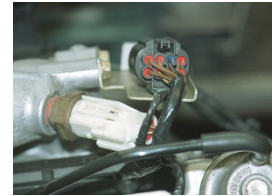

Air temperature sensor

MAP Sensor The MAP sensor is a pressure sensitive component consisting of a diaphragm and piezoelectric circuit. It can be a component fitted in the engine compartment or be integral with the ECU. It is connected by a rubber hose to the inlet manifold. The ECU supplies a stabilised reference voltage, usually 5 V, to the sensor. This voltage is adjusted by the MAP sensor electronics to provide an output signal proportional to the sensed absolute atmospheric pressure.

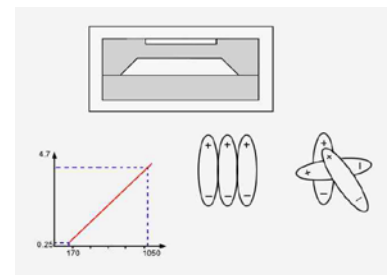

Internal detail of a MAP sensor

Sensor Output □□□ The actual pressure in the manifold is read as a proportional voltage typically from 4.5 V at high pressure, to 0.1 V at low pressure. The electronic circuitry in some MAP sensors converts the reference voltage to a frequency signal that is fed back to the ECU. This is as a proportional frequency (80 to 165 Hz), depending on the vacuum or pressure in the inlet manifold. When the pressure is high, such as at the wide open throttle position, the MAP sensor may also provide a reference signal for actual barometric pressure. This is used as a correction value for changes in altitude, which could lead to poor performance.

Throttle Position Sensor Two types of throttle position sensor are used. Both are fitted to the throttle body and operated by the throttle plate spindle. The two types are a 'throttle switch assembly' and a 'throttle potentiometer'. A throttle switch assembly has two switches, one to indicate the closed throttle or idle position and the other for the wide open throttle position. A throttle potentiometer is a variable resistor with a rotary sliding contact. The sliding contact is moved along the rotary resistance track to provide changes in voltage proportional to the position of the throttle.

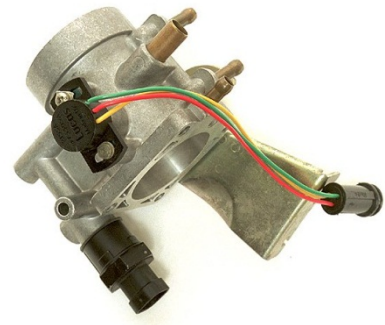

Throttle body with position sensor

Throttle Potentiometer The throttle potentiometer signals are used in the ECU for a number of functions. At the closed throttle position, idle speed and deceleration fuel cut-off are controlled. In the part open throttle position (about 5% to 70% open); there is normal operation with close control of fuel delivery and exhaust emissions. In the wide open throttle position (70% to 100%), full load enrichment is provided and starting of a flooded engine. During rapid movement of the throttle plate there is acceleration enrichment, depending on the rate of change of the throttle plate and signal voltages from the sensor.

Air Intake Temperature Sensor In order for the ECU to correctly calculate the required fuel for a correct mixture ratio, an accurate figure for air mass is necessary. However, air volume and density are affected by changes in temperature. As the temperature rises, the air density falls. The air flow, or manifold absolute pressure measurement, therefore, must be corrected for temperature. The sensor is a temperature dependent resistor with a negative temperature coefficient (NTC).

Engine Coolant Temperature Sensor The engine coolant temperature sensor is a negative temperature coefficient (NTC) thermistor. It is of a similar type to the air temperature sensor. It is fitted into the water jacket close to the thermostat or bypass coolant circuit passages. The sensor measures the engine coolant temperature and provides a signal voltage to the ECU. This is used for cold start and warm up enrichment as well as fast idle speed control through the idle speed control valve.



Coolant thermistor

Exhaust Gas Oxygen Sensor □□ The Greek letter (λ) lambda is used as the symbol for a chemically correct air to fuel ratio. This is the stoichiometric ratio of 14.7 parts of air to 1 part of fuel by mass. Hence, the use of this letter for naming the sensor that is used to control the amount of fuel delivered, so that a very close tolerance to the stoichiometric ratio is maintained.

Lambda Sensor The lambda sensor is often known as an exhaust gas oxygen sensor. Some of these sensors are electrically heated. Preheating allows the sensor to be fitted lower down in the exhaust stream and prolongs the life of the active element. The sensor measures the presence of oxygen in the exhaust gas and sends a voltage signal to the engine electronic control unit.

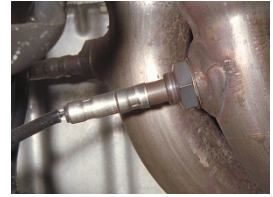

An exhaust gas oxygen sensor

Oxygen Content More fuel is delivered when oxygen content is detected and less fuel when it is not. In this way, an accurate fuel mixture close to the stoichiometric ratio is maintained. This produces the correct exhaust gas constituents for chemical reactions in the catalytic converter. Exhaust gases pass over the active element and when the oxygen concentration on each side is different, an electric voltage is produced. Voltages of about 0.8 V for little or no exhaust oxygen and 0.2 V for higher content are typical outputs.

Systems in Operation Sensors The sensors for power steering and air conditioning are pressure or mechanically operated switches. They provide a voltage signal when the system is in operation. The ECU uses these signals to increase the engine idle speed to accept the increased engine load.



Power steering sensor

Automatic Transmission Switches are used in the automatic transmission. They include the neutral drive switch, which is used for idle speed control, the kick-down switch for acceleration control, and the brake on/off switch, which is used to ensure that the torque converter lock-up clutch is released. This is to prevent the engine stalling as the vehicle comes to rest.



A switch makes when in the park and neutral position

Exhaust Gas Recirculation A transducer measures exhaust gas pressure. It uses a ceramic resistance transducer, which responds to the exhaust gas pressure applied through a pipe connection to the exhaust system. The signal voltage from the electronic pressure transducer is used to regulate the EGR valve. The valve may be operated directly from the ECU if electromechanical or by vacuum through a solenoid vacuum switch.

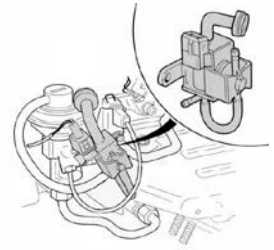



EGR valve

Other Correction Factors

Other correction factors - fuel temperature, octane rating, remote CO adjustment and the service plug or OBD connections. These sensors, variable resistors, switches and multi-plugs provide additional data to the ECU.

The fuel temperature sensor is fitted in the fuel rail. At a pre-set value, a bimetal strip bends to close the signal circuit to the ECU. This signal together with other signals is used by the ECU for optimum fuel delivery during hot engine starting.

 Corrections to injection time

Malfunction Indicator Light  Service and on board diagnostic (OBD) plugs are used for diagnostic and corrective actions with scan tools, dedicated test equipment and other test equipment. If faults are detected the system malfunction indicator lamp on the vehicle fascia will come on. Alternatively, it will fail to go out after the pre-set time duration after switching on the engine. All faults should be investigated as soon as possible. Many electronic systems have a limp home or limited operation strategy program, which allows the vehicle to be driven to a workshop for repair.



Describe the operation of a fuel pressure regulator as manifold pressure changes.



Look back over the previous section and write out a list of the key bullet points here:

Diesel Fuel Injection Systems Diesel engines have the fuel injected into the combustion chamber where it is ignited by heat in the air charge. This is known as compression ignition (CI) because no spark is required. The high temperature needed to ignite the fuel is obtained by a high compression of the air charge.

High Pressure Pump Diesel fuel is injected under high pressure from an injector nozzle, into the combustion chambers. The fuel is pressurised in a diesel injection pump. It is supplied and distributed to the injectors through high pressure fuel pipes. Some engines use a unit injector where the pump and injector are combined in a single unit. The high pressure generation is from a direct acting cam or a separate pump.

Air Flow The air flow into a diesel engine is usually unobstructed by a throttle plate so a large air charge is always provided. Throttle plates may be used to provide control for emission devices. Engine speed is controlled by the amount of fuel injected. The engine is stopped by cutting off the fuel delivery. For all engine operating conditions a surplus amount of air is needed for complete combustion of the fuel.

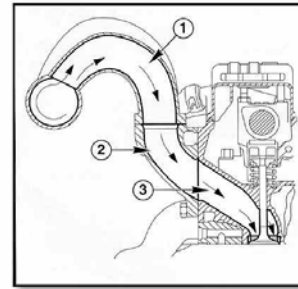

Air

intake for diesel engine

Direct and Indirect Injection Small high speed diesel engine compression ratios are from about 19:1 for direct injection (DI) to 24:1 for indirect injection (IDI). These compression ratios are capable of raising the air charge to temperatures of between 500°C and 800°C. Very rapid combustion of the fuel occurs when it is injected into the hot air charge.

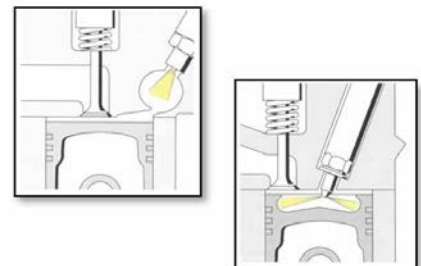

Diesel Combustion Process The combustion process follows three phases. These are the ignition delay, flame spread and controlled combustion phases. In addition, an injection lag occurs in the high pressure pipes as the pressure builds up just before injection.

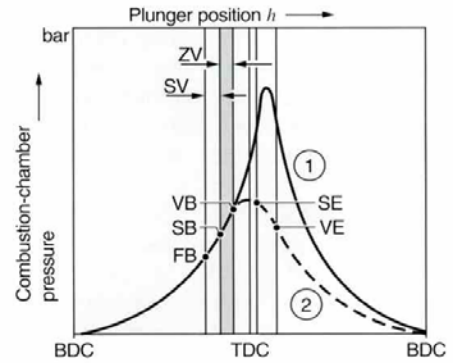

Combustion phases

Phases of Diesel Fuel Combustion The most important phase of controlled combustion is when fuel is being injected into a burning mixture. This must be at a rate that maintains an even combustion pressure onto the piston throughout the critical crankshaft rotational angles. This gives maximum torque and efficient fuel usage, because temperatures remain controlled and the heat lost to the exhaust is minimised. The low temperatures also help to keep nitrogen oxide emissions (NO_x) to a minimum.

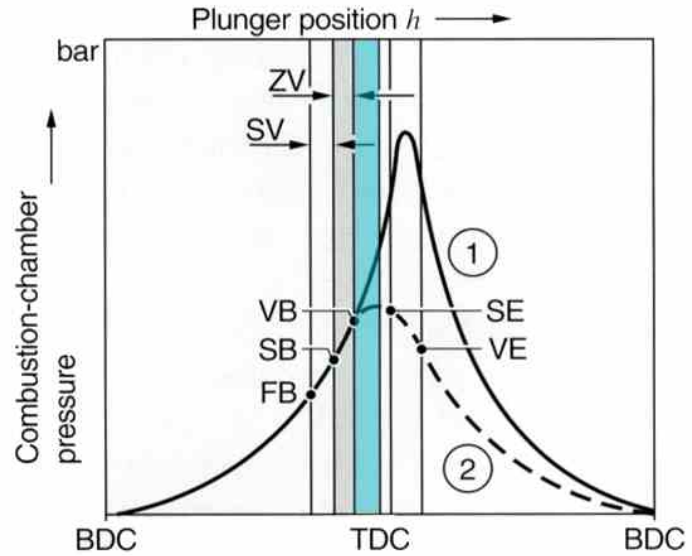

Controlled combustion in cylinder

Flame Spread The speed of flame spread in a diesel engine is affected by the air charge temperature and the atomisation of the fuel. These characteristics are shared with the delay period. A sufficiently high air charge temperature, of at least 450°C , is a minimum requirement for optimum ignition and combustion.

Delay Phase The delay phase or ignition lag for diesel fuel combustion lasts a few milliseconds. It occurs immediately on injection as the fuel is heated up to the self-ignition temperature. The length of the delay is dependent on the compressed air charge temperature and the grade of fuel. The air charge temperature is also affected by the intake air temperature and the engine temperature.

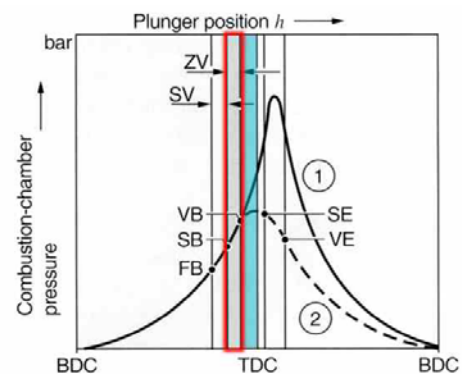

Ignition lag or delay

Diesel Knock A long delay period allows a high volume of fuel to be injected before ignition and flame spread occurs. In this situation diesel knock is at its most severe. When a diesel engine is cold, there may be insufficient heat in the air charge to bring the fuel up to the self-ignition temperature. When ignition is slow, heavy knocking occurs.

Cold Start Devices To aid starting and to reduce diesel knock, cold start devices are used. For indirect injection engines, starting at lower than normal operating temperatures requires additional combustion chamber heating. For direct injection engines, cold start devices are only required in frosty weather.

Initial Delay An initial delay, known as injection lag, occurs in the high pressure fuel lines. This occurs between the start of the pressure rise and the point when pressure is sufficient to overcome the compression spring force in the injectors.



Glow plug



Pipes and injectors

Diesel Fuel Injection Timing Ignition of the fuel occurs in the combustion chamber at the time of injection of fuel into the heated air charge. The injection point and the ignition timing are therefore, for all purposes, the same thing.



Ignition timing mark

Injection Timing Diesel engine injection timing is equivalent to the ignition timing for petrol engines. Injection timing must fall within a narrow angle of crankshaft rotation. It is advanced and retarded for engine speed and load conditions. Injection timing is set by accurate positioning of the fuel injection pump. Incorrect timing leads to power loss. An increase in the production of nitrogen oxides (NO_x) when too far advanced or an increase in the hydrocarbon (HC) emissions, when too far retarded also occurs.



Diesel pump being timed on engine

Particulates Another exhaust gas constituent is particulate emissions. These result from incomplete combustion of the fuel. Particulates are seen as black carbon smoke in the exhaust under heavy load or when fuel delivery and/or timing is incorrect. White smoke may also be visible at other times, such as when the injection pump timing is incorrect. It also occurs when compression pressures are low or when coolant has leaked into the combustion chambers.

Direct and Indirect Injection Direct injection (DI) is made into a combustion chamber formed in the piston crown. Indirect injection (IDI) is made into a pre-combustion chamber in the cylinder head. Direct injection engines are generally more efficient but the indirect types are quieter in operation. The internal stresses in the engine are very high. Direct injection produces a higher detonation stress than indirect injection and therefore the smaller engines tended, until recently, to be the indirect type.

Electronic Control Recent developments in electronic diesel fuel injection control have made it possible to produce small direct injection engines. It is probable that all new designs of diesel engine will be of this type. Diesel engines are built to withstand the internal stresses, which are greater than other engines. Diesel engines are particularly suitable for turbocharging. This improves power and torque outputs.

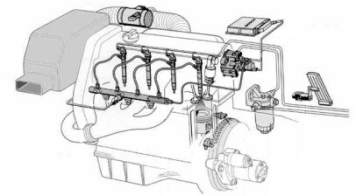

Common rail injection

Exhaust Gas

Recirculation Exhaust gas recirculation (EGR) has two advantages for diesel engine operation. EGR is usually used to reduce nitrogen oxide (NO_x) emissions and this is true for diesel engines.

Additionally, a small quantity of hot exhaust gas in the air charge of a cold engine helps to reduce the delay period and the incidence of cold engine diesel knock.

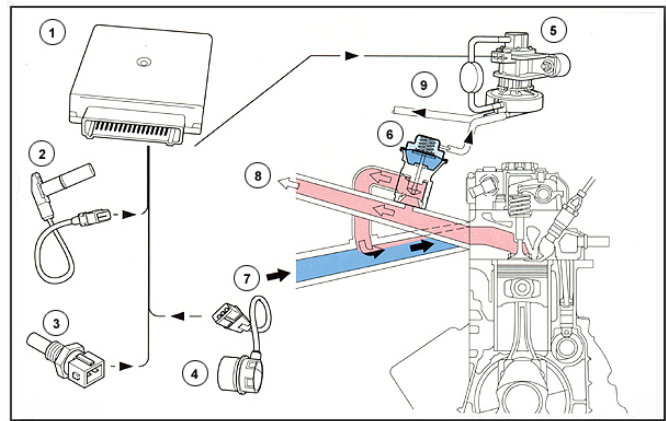

EGR

Catalytic Converters Many modern diesel engined vehicles are fitted with oxidation catalytic converters that work in conjunction with other emission components to reduce hydrocarbon and particulate emissions. Turbo charging, EGR and catalytic converters are described in the Air Supply, Exhaust and Emission Control learning programme.



Inside a catalytic converter

Injection Pressures The fuel systems for direct and indirect injection are similar and vary only in injection pressures and injector types. Until recently, all light high speed diesel engines used rotary diesel fuel injection pumps. These pumps producing injection pressures of over 100 bar for indirect engines. However, these can rise up to 1000 bar at the pump outlet, for turbocharged direct injection engines.

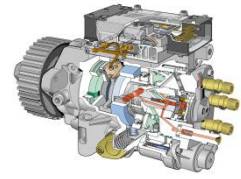

Bosch injection pump

Pressure Differential □□□ Injectors operate with a pulsing action at high pressure to break the fuel down into finely atomised parts. Atomisation is critical to good fuel distribution in the compressed air charge. The air charge pressure may be in excess of 60 bar. The pressure differential, between the fuel injection pressure and air charge pressure, must be sufficient to overcome the resistance during injection. This will also give good fuel atomisation and a shorter injection time.

Swirl An aid to good fuel distribution in the air charge is the swirl in the air flow induced in the inlet manifold. This is created by the combustion chamber design. Air flow into and out of the pre-combustion chamber produces a swirl in the chamber. These chambers are often referred to as swirl chambers. The 'bowl in piston' combustion chambers, of direct injection engines, are shaped to maintain the induction air swirl during compression and combustion.

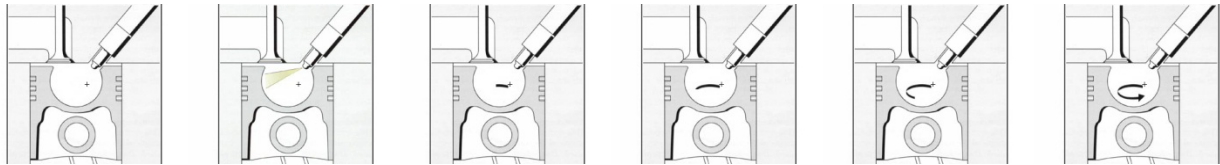

Diesel Fuel Injection Components The main components of a diesel fuel system provide for either the low pressure or the high pressure functions. The low pressure components are the fuel tank, the fuel feed and return pipes and hoses, a renewable fuel filter with a water trap and drain tap, and a priming or lift pump. Fuel heaters may be fitted in the filter housing to reduce the risk of paraffin separation and waxing at freezing temperatures.

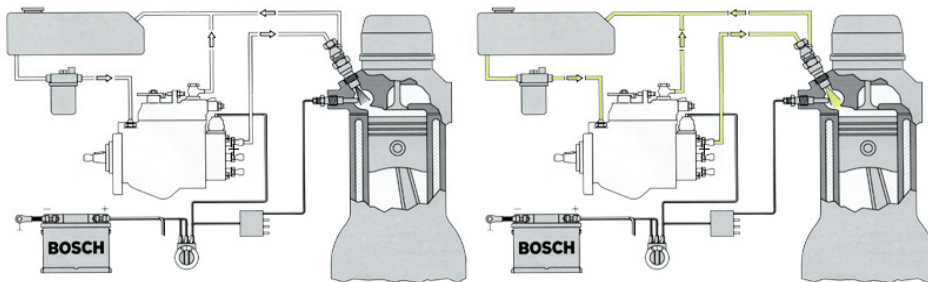

System components

High Pressure Components The high pressure components are the fuel injector pump, the high pressure pipes and the injectors. Other components provide for cold engine starting. Electronically controlled systems include sensors, an electronic diesel control (EDC) module and actuators in the injection pump.



Injection pump, pipes and injectors

Low Pressure Components The fuel tank is a pressed steel sealed unit, treated both inside and out with anti-corrosion paint. The inside is treated in order to resist corrosion from water that accumulates at the bottom of the tank. Some modern tanks are manufactured from a plastic compound that is burst proof in an accident. They are also unaffected by the diesel fuel, which can attack some plastic materials.



Fuel tank

Low Pressure Fuel Lines □□□ Low pressure fuel lines are steel or hard plastic and connections made with short hoses clamped at each end. New vehicles are using quick coupling connections for ease of service and assembly operations. The feed lines run from the tank to the filter and then onto the injection pump. A low pressure return line is used to maintain a fuel flow through the injection pump and the fuel injectors for lubrication and cooling. The return carries fuel back to the filter housing or the fuel tank.

Fuel Filter The fuel filter is a micro-porous paper element in a replaceable canister or detached filter bowl. The filter includes a water and sediment trap and tap for draining the water. Many vehicles have a sensor in the water trap. This completes a warning lamp circuit when water is detected above a certain level. All diesel fuel entering the injection pump and injectors must be fully filtered. The internal components of the pump and injectors are manufactured to very fine tolerances. Even very small particles of dirt could be damaging to these components.



Filter and housing

Fuel Heating Fuel heating may be provided from the engine coolant or by an electric heater element in the filter housing. The fuel is lifted from the fuel tank to the injection pump by the transfer pump in the injection pump on some vehicles. This is possible where the distance and height of lift are of small dimensions.



Injection pump



Heated fuel filter housing

Fuel Lift Pump For improved delivery and for priming the injection pump another pump may be necessary. A conventional fuel lift pump driven from the engine camshaft is a common method. These pumps in some instances have an external operating lever. Hand operated priming pumps are fitted for use when the vehicle runs out of fuel. They are also used for service operations such as when the filter is changed. Many modern injector pumps are self-priming.



Fuel priming pump

Injection Pump The injector pump shown is a rotary distributor type pump. These pumps are filled with diesel fuel, which provides not only fuel for the engine, but also for full lubrication and cooling of the pump. These pumps are made from specially manufactured materials with surface treatments. Parts are lapped together to give very fine tolerances. Only clean and filtered fuel should be used to avoid damage to these parts.

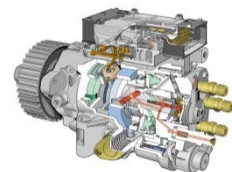

Rotary injector pump

Types of Pump There are two types of pump with different internal operation. Two major original designers make or license the manufacture of these pumps. The Lucas DP and Bosch VR pumps are radial-piston designs. They use opposing pistons or plungers inside a cam ring to produce the high pressure. Bosch V series pumps are axial-piston designs having a roller ring and cam plate attached to an axial piston or plunger in the distributor head to generate the high pressure.

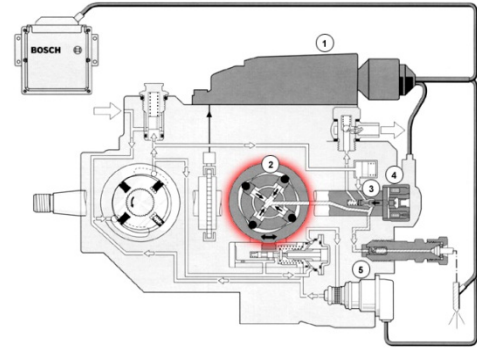

Bosch VR pump radial pistons

Pump Operation The operation of the two types of injector pump are quite different and explained separately further on in this section. Later versions of these pumps have electrical and electronic control. The latest versions have full electronic control.

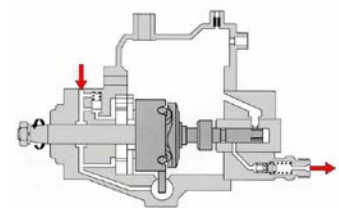

Bosch VE pump cam plate and plunger

High Pressure Outlets All types of pumps have delivery valves or pressure valves fitted to the high pressure outlets, which feed to each cylinder in turn. The delivery valves control the generation of pressure waves in the high pressure pipes. They do this by giving initially a quick pressure drop and then by retaining a lower residual pressure. The delivery valve consists of a conical valve held closed by a compression spring and opened by hydraulic pressure when injection pressures are produced in the injection pump.



Delivery valves

Delivery Valve □□□ Closure of the delivery valve when the injector pump pressure drops, allows a quick pressure drop in the pipe and injector. This means the injectors will close fully. Without the valve, pressure waves would oscillate in the pipe and force the injector to reopen. This would cause unwanted fuel to be injected. The retained low pressure helps to prevent fuel dribble from the injector nozzle during the non-injection period. It also aids lubrication through the leak-off pipes.

High Pressure Pipes The high pressure pipes are of double thickness steel construction and are all of the same length. This is so that the internal pressure rise characteristics are identical for all cylinders. The high pressure connections are made by rolled flanges on the pipe ends and threaded unions securing the rolled flanges to convex, or occasionally concave, seats in the delivery valves and injectors.

Fuel Injectors The fuel injectors are fitted into the cylinder head with the nozzle tip projecting into the pre-combustion (IDI) or combustion chamber (DI). The injectors for indirect combustion are of a pintle or 'pintaux' design and produce a conical spray pattern on injection. The injectors for direct injection (DI) are of a pencil type multi-hole design that produces a broad distribution of fuel on injection.



DI injector

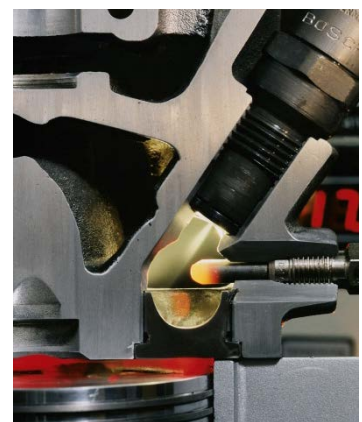

IDI injector

Injector Operation □□□ Fuel injectors are held closed by a compression spring. They are opened by hydraulic pressure when it is sufficient to overcome the spring force on the injector needle. The hydraulic pressure is applied to a face on the needle where it sits in a pressure chamber. The fuel pressure needed is in excess of 100 bar (1500 psi). This pressure lifts the needle and opens the nozzle, so that fuel is injected in a fine spray pattern into the combustion chamber.

Injector Spray □□□ The pressure drops when fuel is injected and the spring force on the needle closes the injector. This is immediately followed up by a build-up of pressure that again opens the nozzle. This results in a cycle of oscillations of the needle to give a finely atomised and almost continuous spray. The spray continues until the pump pressure is reduced at the end of the delivery stroke.

New Types of Injector The newer types of injector have two springs of different value in order to provide a small initial charge for ignition and then the main charge for controlled burning. These injectors reduce diesel knock on direct injection engines and give a smoother engine performance. Fuel injectors are carefully matched to the type of engine and pump.

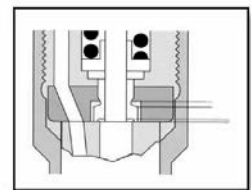

Two spring direct injection injector

Glow Plugs □□ There are two types of cold starting devices used on diesel engines. These are glow plugs and flame start devices. Glow plugs are used mainly on indirect injection engines although they are used on some small direct injection engines. Flame start devices are used on many, but not all, direct injection engines. Glow plugs are fitted in the combustion chamber. Their purpose is to help to ignite the fuel during injection.

Flame Start Devices

Flame start devices are fitted in the inlet manifold. They preheat the intake air so that it achieves a high temperature on the compression stroke. This diagram shows the components of a flame start device and the electrical control circuit.

 Flame start device



Make a simple sketch to show all the common components of a diesel fuel injection system.



Look back over the previous section and write out a list of the key bullet points here:

TOOLS AND EQUIPMENT

Fuel System Inspection and Repair The abbreviation R&R is short for the removal and replacement of components, or remove and reassemble components. The fuel system components will usually be removed, inspected and repaired or replaced only when faults occur. Before starting any work on fuel systems, always consider safety precautions applicable to the type of fuel. Obtain all safety equipment that may be needed for the task. Refer to manufacturer's instructions for any special precautions and particularly for releasing fuel pressure.

Correct Adjustments It is important to follow manufacturer's instructions for all work that is carried out. The fuel systems must perform to environmental regulations. In order to ensure that the system continues to meet the requirements of the regulations, they need to be correctly fitted and adjusted. It is not possible to guarantee any work unless it conforms to the original specification.



Air flow meter adjustment

Cleanliness All fuel systems have components built to fine engineering tolerances. In service, fine mesh fuel filters keep the components clean. It is equally important during repair work that the same standard of absolute cleanliness is maintained. On petrol systems, small particles of dirt can block the very small holes in carburettor jets and fuel injectors. On diesel systems, small particles of grit that enter the injector pump or injectors can cause expensive damage. Always cap any open pipes or unions.



Fuel filter



Air filter

Specialist Tools There is a wide range of specialist tools that are needed to carry out repair and adjustment of fuel systems. Most of these are specific to one type of vehicle or one type of fuel system.

Carburettor Tools Carburettor tools include a range of spanners and screwdrivers for adjusting mixture strength and for setting the engine idle speed. Also needed for this is an engine speed tachometer.



Adjustment kit

Gauges and Measuring Devices Other carburettor tools, gauges and measuring devices are needed for setting the float level. As there is a large range of different carburettors, the correct type of tool or setting procedure is required. Always follow manufacturer's instructions for these tasks.



Simple measuring tools are important

Air Flow Measurements For adjusting the airflow through twin or multiple carburettors, a special vacuum gauge that fits over the air intake port of the carburettors is used. The use of this gauge is the only reliable method of balancing the airflow through the carburettors.



Balancing gauge

Adjusting Keys Petrol fuel injection special tools include adjusting keys for Bosch Jetronic mixture strength. A special relay may be used in place of the pump relay so that fuel flow rates through individual injectors can be measured. Calibrated measuring containers are used for this test.



Adjustment key

Diagnostic Equipment There are many items of diagnostic equipment available to test fuel system components. These include engine and exhaust gas analysers. Multimeters can be used to check electrical and electronic component voltages and resistance.



Multimeter display and controls

Measuring Fuel Flow There is a specific system equipment for measuring fuel flows from individual fuel injectors. This is to allow checks against specifications and for comparison against each other.



Injector flow test

Diesel Test Equipment Diesel engine test equipment is available for calibrating and phasing diesel injector pumps. Equipment for testing diesel injector operating pressures and spray patterns is also available. Special equipment must be used to set up and time diesel injector pumps when fitting to the engine.

Special Spanners and Pullers For all petrol injection systems, there is a range of special spanners and pullers for removing and replacing injectors, sensors and other components. There is also an injector cleaning system that can be used to remove a build-up of lacquer in petrol injector nozzles. Fuel additives can also be used for this purpose.



Injector tools...



Come in...



Many shapes...



And sizes!

Pressure Gauges For carrying out pressure tests, there is a range of pressure gauges with adapters to suit all vehicle and fuel system types.



Fuel pressure gauge



Adapter kit

Electronic Diagnostic Equipment □□□ Electronic diagnostic equipment is used for many tests on the electrical and electronic circuits or components of fuel systems. Further tests include visual inspections for the condition of terminals and wiring. A useful test for intermittent faults or electrical failure is a 'wiggle' test of the wiring to see if this has any effect.

Diesel Pump Test Rigs For diesel fuel systems, the range of special equipment includes diesel pump test rigs, diesel injector testers and glow plug testers. A high range ammeter may be required to carry out checks on glow plugs.



50A ammeter shunt

Diesel Injection Pump Timing For removing, replacing and adjusting the timing of injection pumps, follow the manufacturer's instructions precisely. There will be a requirement to use the special tools designed for the task. These include, on some pumps, a dial test indicator and special plunger extension. For many types of pump, the engine, camshaft and pump drive are held with locating dowels to ensure that the pump timing is set correctly.



Dial test indicator in use

Strap Wrenches For removing and replacing fuel injectors, some special socket spanners and pullers are required. These vary as to the type of injector and engine manufacturer. Strap wrenches used for engine oil filters can also be used on canister filters.



Filter...



Wrenches

Other Systems For all engine repair work, it is worthwhile to remember that other systems can contribute to the symptoms, or be responsible for the failure of a specific component. Blocked air filters, defective catalytic converters and failure of emission control components are three examples. All of these can affect the function of the fuel system.



Look back over the previous section and write out a list of the key bullet points here:

Introduction Scheduled service requirements for the engine fuel systems should be carried out together with checks of:

- The mechanical condition of the engine.
- The ignition system operation.
- Emission control system operation.

Visual Inspections □□□ A key part of all routine maintenance at each scheduled service interval is a visual inspection for fuel leaks. This inspection should be carried out with care as fuel leaks carry a potential fire risk to the vehicle and occupants.

Filter Replacement At regular specified intervals the fuel filter is replaced. On diesel fuel systems, the water trap in the filter housing is usually drained at every service and the filter element changed at the major service interval. These requirements do vary so check manufacturer's recommendations.



Fuel filter on the vehicle

Service Schedules Check with individual vehicle service schedules for work carried out at long-term intervals. This may include checks on fuel injector condition, starting device operation and for diesel engines, replacement of the fuel injectors and glow plugs.

Fault Codes Check the engine electronic control unit for fault codes. Where an on board diagnostic (OBD) computer link is used, run the standard service checks. Report any faults found during service operations to the owner or driver of the vehicle.



Fault code reader



Worksheet Routine maintenance

inspections, lubrication and replacement of parts.

Follow the appropriate inspections shown in the 'System performance' section of this learning programme for the items specified in the scheduled service.

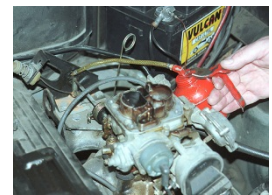

Oiling a carburettor linkage

Lubrication Lubrication of fuel supply components will include throttle cable linkages for petrol and diesel fuel systems. The choke mechanism on carburettors requires regular lubrication for correct operation. Lubrication of the throttle spindle will keep wear of the bushes to a minimum and prevent an unwanted airflow through the spindle bushes.

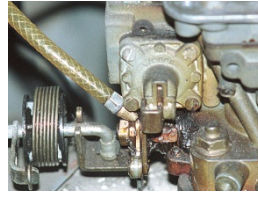

Throttle spindle



Choke spindle

Fuel Filter The main specified item for regular replacement is the fuel filter. However, inspection of fuel supply pipes and hoses may indicate that these also need to be replaced before problems that are more serious occur.



Fuel filter



Fuel system hoses

Exhaust Gas Check exhaust gases such as carbon monoxide (CO) and hydrocarbons (HC) with a gas analyser. Compare the results with the manufacturer's specifications and environmental regulations. Check for fault codes with an appropriate reader or data link.



Exhaust gas analyser



Worksheet Replace and/or clean fuel

filters.

Always replace a fuel filter with one specified for the vehicle. Avoid the use of poor quality substitutes as these can lead to problems. For petrol engined vehicles, remove the battery earth or ground cable before carrying out this task. There is usually some petrol spilt during this operation and all safety precautions should be observed.



Disconnect the battery earth

Filter Positions The approach to carrying out this task will depend on the position of the fuel filter. Where the filter is under the vehicle, it will usually be close to the fuel tank and be connected by two rubber hoses sealed with hose clamps. The filter may also be connected with threaded unions at each end. The new filter should be matched to the old one before removal and the direction of flow established from the arrows on the casing.



Filter under the vehicle



Filter in engine bay

Filter Removal If possible, have an assistant ready to catch any lost fuel in a suitable container. Undo and plug the feed pipe from the fuel tank to the filter. Always remove this way round so that the filter does not continue to leak fuel from the tank whilst it is being removed. A small flow back of fuel will occur. Catch any fuel lost at this time.



Fuel drainer

Connecting Hoses Undo and remove the other end of the filter and fit the new one with the flow arrow in the right direction. This is with the arrow pointing away from the fuel tank. Replace the connecting hoses if these show any signs of deterioration. Check the tightness of the hose clips a second time after fitting as a safety check against missing this important part of the task.



Filters are directional

Diesel Fuel Filters For diesel fuel filters it is extremely important to work in a very clean way, so no dirt enters the fuel pipes down line from the filter. Wipe the filter body and the filter head before removal. Wash clean if the area is particularly dirty. Check that the new filter is as specified by the manufacturer and matches the one being replaced.



Cleanliness is important

Bowl Type Filters Most modern diesel engine filters are of the replaceable canister type. However, many still use a bowl with a separate filter element. Position a drain tray or a cloth below the filter to catch any lost fuel.



Diesel filter

Canister Filters It may be possible to undo these filters by hand, but if not, use a strap wrench. Where a 'water in fuel' sensor is fitted, disconnect the multi-socket before rotating the filter so that the cables do not become damaged. When removed check that the old sealing rings are removed before the new filter is fitted.



Water trap



Drain plug

Sealing Rings Lubricate the sealing rings with diesel fuel before fitting the filter. Replace the 'water in fuel' sensor, if fitted, and screw the filter on until the seal makes contact with the filter head. Screw tight by a further three quarters of a turn. Reconnect the sensor multi-socket.



Sealing rings

Bleeding the Fuel System Follow the manufacturer's procedures for bleeding the fuel system and diesel injection pump where this is necessary. Some diesel vehicles require a priming pump to be operated until a resistance is felt and in others, the pump is self-priming as the engine is cranked and running. Run the engine and check for fuel leaks. Recheck for leaks after a road test.



Hand primer pump



Look back over the previous section and write out a list of the key bullet points here:

FUEL - CUSTOMER CARE

Introduction There are not many points that a technician may make to customers regarding the fuel system. However, one important point is to advise them to use the correct fuel. Some old high performance vehicles required a high-octane fuel, which is now no longer available. LRP or lead replacement fuels can be used for these vehicles. Specific data for individual vehicles is available from manufacturers.

Customer Records Customer records should be kept for the frequency and type of service carried out so that a check can be made on rubber hoses at appropriate time intervals. This is good practice to avoid the risk of fuel leakage and the potential for vehicle fires.

Fuel Leakage Another point in respect of vehicle fires caused by fuel leakage is to show customers where to look for fuel leaks and what to look for. Always advise customers to report any leaks or if they notice fuel odour around the vehicle or under the bonnet.



Keep customers informed if you find a leak

The Wrong Fuel... Advise customers of the potential harm if the fuel tank is topped up with the wrong fuel. That is petrol in a diesel vehicle and diesel in a petrol vehicle. Let them know that if quantities greater than 5% have been added, then they should not attempt to start the engine but should have the system drained, cleaned and refilled.

ELECTRICAL SYSTEMS

ELECTRICAL AND ELECTRONIC PRINCIPLES

ELECTRICITY AND THE ATOM

Electricity To understand electricity properly we must start by finding out what it really is. This means we must think very small! The molecule is the smallest part of matter that can be recognised as that particular matter. Sub-division of the molecule results in atoms. The atom is the smallest part of matter.

The Atom □□□ The atom consists of a central nucleus made up of protons and neutrons. Around this nucleus electrons orbit, like planets around the sun. The neutron is a very small part of the nucleus. It has an equal positive and negative charge. It is therefore neutral and has no polarity. The proton is another small part of the nucleus, it is positively charged. As the neutron is neutral and the proton is positively charged, this means the nucleus of the atom is positively charged.

The Electron □□□ The electron is an even smaller part of the atom, and is negatively charged. It is held in orbit around the nucleus by the attraction of a positively charged proton. When atoms are in a balanced state the number of electrons orbiting the nucleus equals the number of protons. The atoms of some materials have electrons, which are easily detached from the parent atom and join an adjacent atom. In so doing they move an electron (like polarities repel) from this atom to a third atom and so on through the material. These are called free electrons.

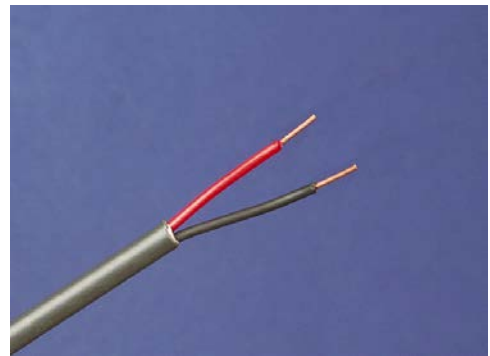

Insulated conductors

✎ Sketch the atom and show the free electron here

Conductors and Insulators Materials are called conductors if the electrons can move easily. However, in some materials it is difficult to move the electrons. These materials are called insulators.

Electron Flow □□□ If an electrical pressure (voltage) is applied to a conductor, a directional movement of electrons will take place. There are two conditions for electrons to flow: a pressure source, e.g. from a battery or generator and a complete conducting path for the electrons to move e.g. wires.

Electric Current □□□ An electron flow is termed an electric current. Shown here is a simple electric circuit. The battery positive terminal is connected, through a switch and lamp, to the battery negative terminal. With the switch open, the chemical energy of the battery will remove electrons from the positive terminal to the negative terminal via the battery. This leaves the positive terminal with less electrons and the negative terminal with a surplus of electrons. An electrical pressure exists between the battery terminals. With the switch closed, the surplus electrons on the negative terminal will flow through the lamp back to the electron deficient positive terminal. The lamp will therefore light until the battery runs down.

Conventional Flow □□□ The movement from negative to positive is called the electron flow. However, it was once thought that current flowed from positive to negative. This convention is still followed for practical purposes. Therefore, even though it is not correct, the most important point is that we all follow the same convention. We say that current flows from positive to negative.

Effects of Current Flow □□□ When a current flows in a circuit, it can produce only three effects: heat, magnetism and chemical. The Heating Effect is the basis of electrical components such as lights and heater plugs. The Magnetic Effect is the basis of relays and motors and generators. The Chemical Effect is the basis for electroplating and battery charging. The three effects are reversible. For example, electricity can make magnetism, and magnetism can be used to make electricity.



Heating Effect

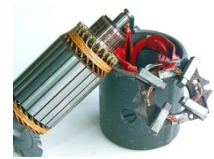

Magnetic Effect





Chemical Effect



Reversibility - motor and generator

Voltage, Current, Resistance and Power □□□ In this figure, the number of electrons through the lamp every second is the rate of flow. The cause of electron flow is the electrical pressure. The lamp produces an opposition to the rate of flow set up by the electrical pressure. Power is the rate of doing work or changing energy from one form to another. All these quantities are given names as shown here.

Ohm's Law  If the voltage applied to the circuit was increased but the lamp resistance stayed the same, then current would increase. If the voltage was maintained, but the lamp was changed for one with a higher resistance, the current would decrease. This relationship is put into a law called Ohm's Law. This law states that in a closed circuit the current is proportional to the voltage and inversely proportional to the resistance. Any one value can be calculated if the other two are known.

Power Equation  When voltage causes current to flow, energy is converted. This is described as power. The unit of power is the Watt. As with Ohm's law, any one value can be calculated if the other two are known.



State the three effects of electricity.



Look back over the previous section and write out a list of the key bullet points here:

BASIC ELECTRIC CIRCUITS AND MAGNETISM

Conductors, Insulators and Semi-

Conductors

All metals are conductors. Silver, copper and aluminium are among the best and are frequently used.

Liquids, which will conduct an electric current, are called electrolytes.

Insulators are generally non-metallic and include rubber, porcelain, glass, plastic, cotton, silk, wax, paper and some liquids. Some materials can act as either insulators or conductors depending on conditions. These are called semi-conductors. They are used to make transistors and diodes.



Insulator



Conductor



Semi-conductor



Electrolyte

Factors Affecting Resistance of a Conductor The amount of resistance offered by a conductor is determined by a number of factors.

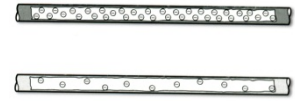

Conductor resistance

Length - the greater the length the greater the resistance.

Cross sectional area - the larger the area the smaller the resistance.

The material - the resistance offered by a conductor will vary according to the material from which it is made.

Temperature - most metals increase in resistance as temperature increases.

Series Circuits When resistors are connected so that there is only one path for the same current to flow through each resistor they are connected in series. In a series circuit:

Current is the same in all parts of the circuit

Applied voltage equals the sum of the volt drops around the circuit

 A simple series circuit

Total resistance of the circuit, equals the sum of the individual resistance values.

Parallel Circuits When resistors are connected such that they provide more than one path for the current to flow in, and have the same voltage across each component, they are connected in parallel. In a parallel circuit:

Voltage across all components of a parallel circuit is the same.

Total current from the source is the sum of the current flowing in each branch. The current splits up depending on each component resistance.

 A simple parallel circuit

Total resistance of the circuit is the sum of the reciprocal (one divided by the resistance) values.

Magnetism and Electromagnetism Magnetism can be created by a permanent magnet or by an electromagnet. The space around a magnet in which the magnetic effect can be detected is called the magnetic field. Flux lines or lines of force represent the shape of magnetic fields in diagrams. Electromagnets are used in motors, relays and fuel injectors to name just a few. Force on a current carrying conductor in a magnetic field is caused because of two magnetic fields interacting. This is the basic principle of how a motor works.

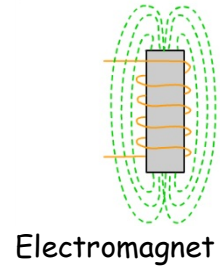

Electromagnetic Induction When a conductor cuts or is cut by magnetism a voltage is induced in the conductor. The direction of this voltage depends upon the direction of the magnetic field and the direction in which the field moves relative to the conductor. The size is proportional to the rate at which the conductor cuts or is cut by the magnetism. This effect of induction, meaning that voltage is made in the wire, is the basic principle of how generators such as the alternator on a car work. A generator is a machine that converts mechanical energy into electrical energy.

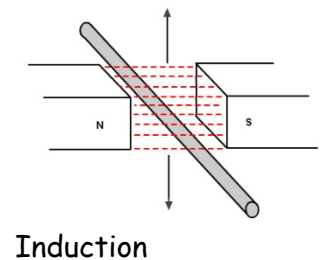

Mutual Induction If two coils, primary and secondary, are wound on to the same iron core, any change in magnetism of one coil will induce a voltage in the other. This happens when the primary current is switched on and off. If the number of turns of wire on the secondary coil is more than the primary, a higher voltage can be produced. This is called transformer action and is the principle of the ignition coil.

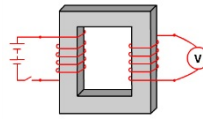

Transformer



Ignition coil



State the factors that affect the resistance of a conductor.



Look back over the previous section and write out a list of the key bullet points here:

VEHICLE ELECTRICAL COMPONENTS AND CIRCUITS

Switches A switch is a simple device used to break a circuit, that is, it prevents the flow of current. A wide range of switches is used. Some switches are simple on/off devices such as an interior light switch on the door pillar. Other types of switch are more complex. They can contain several sets of contacts to control, for example, the indicators, headlights and horn. These are described as multifunction switches.

Resistors Good conductors are used to carry the current with minimum voltage loss due to conductor resistance. Resistors are used to control the current flow in a circuit or to set voltage levels. They are made of materials that have a high resistance. Resistors to carry low currents are often made of carbon. Resistor for high currents are usually wire wound.

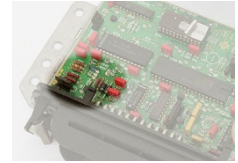

Resistors in use

 Resistor symbol

Relays A relay is a very simple device. It can be thought of as a remote controlled switch. A very small electric current is used to magnetise a small winding. The magnetism then causes some contacts to close, which in turn can control a much heavier current. This allows small delicate switches to be used, to control large current users, such as the headlights or the heated rear window.



Simple 'cube' relay

Capacitors A capacitor is a device for storing an electric charge. In its simple form, it consists of two plates separated by an insulating material. One plate can have excess electrons compared to the other. On vehicles, its main uses are for reducing arcing across contacts and for radio interference suppression circuits as well as in electronic control units.

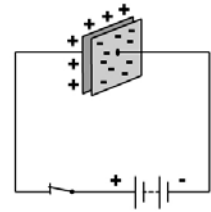

Capacitor operation

Fuses □□ Some form of circuit protection is required to protect the electrical wiring of a vehicle and to protect the electrical and electronic components. It is now common practice to protect almost all electric circuits with a fuse. A fuse is the weak link in a circuit. If an overload of current occurs then the fuse will melt and disconnect the circuit before any serious damage is caused. Automobile fuses are available in three types: glass cartridge, ceramic and blade type. The blade type is now the most popular choice due to its simple construction and reliability. Fuses are available in a number of rated values. Only the fuse recommended by the manufacturer should be used.

Current rating	Colour Code
3	
4	
5	
7.5	
10	
15	
20	
25	
30	

 Colour in the table

Purpose of a Fuse □□ A fuse is to protect the device as well as the wiring. A good example of this is a fuse in a wiper motor circuit. If a value were used, which is much too high then it would still protect against a severe short circuit. However, if the wiper blades froze to the screen, a large value fuse might not protect the motor from overheating.

Fusible Links Fusible links in the main output feeds from the battery protect against major short circuits in the event of an accident or error in wiring connections. These links are simply heavy-duty fuses and are rated in values such as 50, 100 or 150A.



These links connect to the battery

Circuit Breakers Occasionally circuit breakers are used in place of fuses, this being more common on heavy vehicles. A circuit breaker has the same rating and function as a fuse but with the advantage that it can be reset.

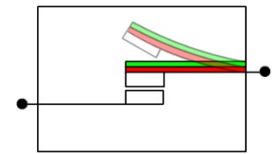

A bimetal strip is the main component

Terminals and Connectors Many types of terminals are available. These have developed from early bullet type connectors into high quality waterproof systems now in use. A popular choice for many years was the spade terminal. This is still a standard choice for connection to relays for example, but is now losing ground to the smaller blade terminals. Circular multi-pin connectors are used in many cases; the pins varying in size from 1mm to 5mm. With any type of multi-pin connector an offset slot or similar is used to prevent incorrect connection.

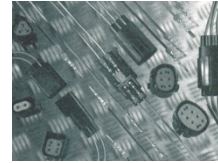

Selection of terminals and connectors

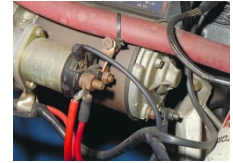

Terminals and connectors in use

Protection Protection against corrosion of the connector is provided in a number of ways. Earlier methods included applying suitable grease to the pins to repel water. It is now more usual to use rubber seals to protect the terminals although a small amount of contact lubricant can still be used. Many multi-connectors use some kind of latch to prevent not only individual pins working loose but also to ensure that the complete plug and socket is held securely.



Waterproof connector block

Wires Cables or wires used for motor vehicle applications are usually copper strands insulated with PVC. Copper, beside its very low resistance, has ideal properties such as ductility and malleability. This makes it the natural choice for most electrical conductors. For the insulation, PVC is ideal. It not only has very high resistance, but also is very resistant to fuel, oil, water and other contaminants.



Cables in a wiring harness

Cable Size The choice of cable size depends on the current it will have to carry. The larger the cable used then the better it will be able to carry the current and supply all of the available voltage. However, it must not be too large or the wiring becomes cumbersome and heavy! In general, the voltage supply to a component must not be less than 90% of the system supply. Cable is available in stock sizes but a good 'rule of thumb' guide, is that one strand of 0.3mm diameter wire will carry 0.5 amps safely.



Heavy duty cable



Light duty cable

UK Colour Code The UK system uses twelve colours to determine the main purpose of the cable. Tracer colours further define its use. The main colours used and some other examples are given in the table. 

European System  A 'European' system used by Ford, VAG, BMW and other manufacturers is based *broadly* on the following table. Please note that there is no connection between the 'Euro' system and the British standard colour codes. In particular, note the use of the colour brown in each system! 

Terminal Numbers  A popular system is the terminal designation. This helps to ensure correct connections are made on the vehicle, particularly in after sales repairs. It is important however to note that the designations are not to identify individual wires but are to define the terminals of a device. Listed here are some of the popular numbers.



Symbols and Circuit

Diagrams The selection of symbols shown here is intended as a guide to some of those in use. Many manufacturers use their own variation. The idea of a symbol is to represent a component in a very simple but easily recognisable form.

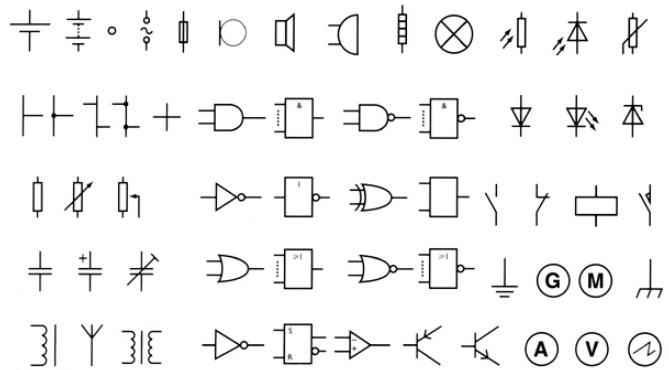

Conventional Circuit Diagram □□□ The conventional type of diagram shows the electrical connections of a circuit but does not attempt to show the various parts in any particular order or position.

Layout Circuit Diagram A

layout circuit diagram attempts to show the main electrical components in a position similar to those on the actual vehicle. Due to the complex circuits and the number of individual wires some manufacturers now use two diagrams, one to show electrical connections, and the other to show the actual layout of the wiring harness and components.

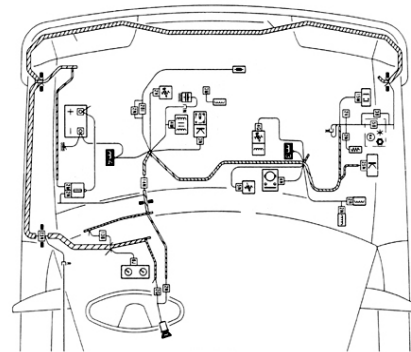

Terminal

Circuit

Diagram A

terminal diagram shows only the connections of the devices and not any of the wiring.

The terminal of each device, which can be represented pictorially, is marked with a code. This code indicates the device terminal designation, the destination device code and its terminal designation

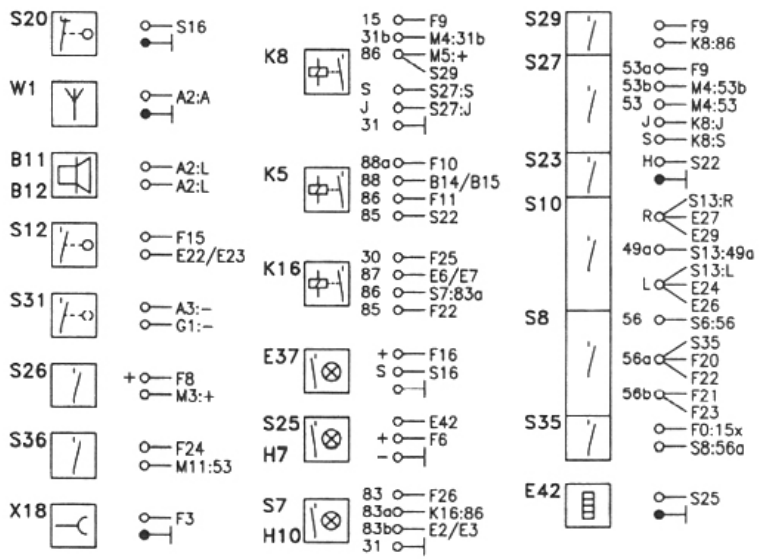

and in some cases the wire

Current Flow Circuit Diagram □□□ This diagram is laid out such as to show current flow from the top of the page to the bottom. These diagrams often have two supply lines at the top of the page marked 30 (main battery positive supply) and 15 (ignition controlled supply). At the bottom of the diagram is a line marked 31 (earth or chassis connection).

Lighting Circuit □□□ Shown here is a basic lighting circuit. Click on each switch in turn to make the circuit operate. Notice the effect of some switches being connected in series.

Describing Electric Circuit Faults

Three descriptive terms are useful when discussing electric circuits:

- Open circuit - the circuit is broken and no current can flow.
- Short circuit - a fault has caused a wire to touch another conductor and the current uses this as an easier way to complete the circuit.
- High resistance - a part of the circuit has developed a high resistance (such as a dirty connection), which will reduce the amount of current that can flow.

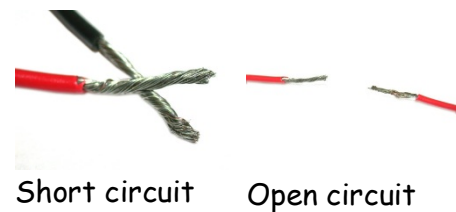

Limits of the Wiring Systems The complexity of modern wiring systems has been increasing steadily. However, in recent years it has increased dramatically. The size and weight of the wiring harness is a major problem. The number of separate wires required on a top of the range vehicle can be in the region of twelve hundred. The wiring loom required to control all functions in or from the driver's door can require up to fifty wires. This is clearly becoming a problem as, apart from the obvious issue of size and weight, the number of connections and number of wires increases the possibility of faults developing.



Wiring harness

Multiplexing If data could be transmitted along one wire and made available to all parts of the vehicle then the vehicle wiring could be reduced to just three wires. These wires would be a main supply, an earth connection and a signal wire. Various signals can be 'multiplexed' on to one wire in two main ways. These are by frequency division and time division multiplexing. Frequency division is similar to the way radio signals are transmitted. Time division multiplexing is generally used for transmission of digital signals. In this case, a time slot is allocated for 'codes' to be sent.

Multiplexed Wiring □□□ The data bus and the power supply cables must 'visit' all areas of the vehicle electrical system. To illustrate the operation of this system consider the events involved in switching the sidelights on and off. First in response to the driver pressing the light switch, a unique signal is placed on the data bus. This signal is only recognised by special receivers built as part of each light unit assembly, these in turn will make a connection between the power ring main and the lights. The events are similar to turn off the lights except that the code placed on the data bus will be different and will be recognised only by the appropriate receivers as an off code.

Controller Area Networks (CAN)

Bosch has developed a protocol known as 'CAN' or controller area network. This system meets practically all requirements with a very small chip surface (easy to manufacture therefore cheaper). CAN is suitable for transmitting data in the area of driveline components, chassis components and mobile

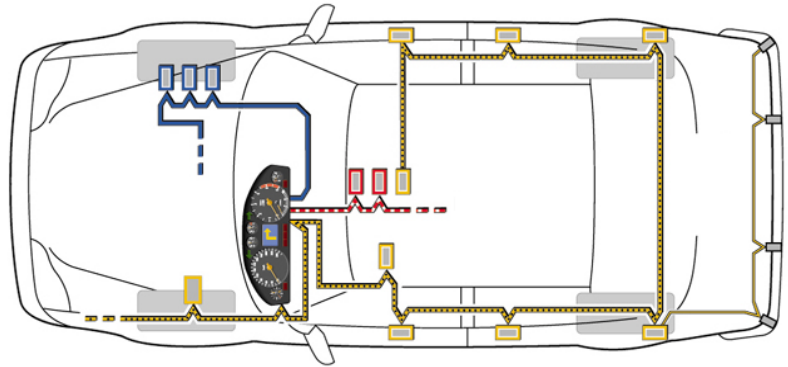

CAN system for instrumentation

communications. It is a compact system, which will make it practical for use in many areas. Two variations on the physical layer are available which suit different transmission rates. One variation is for data transmission of between 100k and 1M bits per second. It is used for rapid control devices. The other variation transmits data between 10k and 100k bits per second. It is used for switching and control operations.



Describe what is meant by an open circuit and a short circuit.



Look back over the previous section and write out a list of the key bullet points here:

TOOLS AND EQUIPMENT

Introduction Components will usually be removed, inspected and repaired or replaced when a defect has been diagnosed. Other components are replaced, or stripped and cleaned, at scheduled mileage or time intervals. Refer to the Routine Maintenance Section for details on these items.

General Toolkit General tools and equipment will be required for most tasks. As your career develops you will build a collection of tools and equipment. Look after your tools and they will look after you!

Electrical Tools There are only a few tools specifically associated with electrical systems. Some of the main ones are covered over the next few screens.

Terminal Kit Many terminal kits are available. They usually consist of a selection of terminals and special pliers to crimp the terminals on to the wire.

Wire Strippers With practice you will be able to strip wire using side cutters. However, special tools are available to make the job easier. A number of different types are shown here.



Selection of wire strippers

Soldering Iron Most soldering irons are electrically heated. However, there are some very good gas powered types now available. The secret with a soldering iron is to use the right size for a specific job. One suitable for delicate ICs and circuit boards will not work on large alternator diodes. More damaging would be to use a large iron on a small circuit board!

Paper Clip Not found in Snap-on or other catalogues, but a very useful tool. It is not only ideal for bridging terminals as shown here; it can also be used for clipping paper together!



Paper clip in use

Summary Small tools such as electricians' screwdrivers or wire cutters are easy to misplace when working on a vehicle. The cost of these items if you lose them is clearly an issue, but so is the chance of damage to the vehicle. A 'spanner' in the works - can cause lots of trouble!



Look back over the previous section and write out a list of the key bullet points here:

Scheduled Servicing Scheduled service requirements are often quite simple but none-the-less important. Systems should be checked for correct operation. Adjustments, repairs or replacements are then made if required.

Non-Routine Work When carrying out routine maintenance, some non-routine work may be found. This should be reported to the driver or owner of the vehicle before repairs are carried out.



Worksheet Service electrical system.



Checking the lights

The main task when servicing the electrical system is to ensure that everything works! However, the battery may require further attention, particularly on older vehicles.

Battery Service If the battery terminals require cleaning, fit a memory keeper and disconnect the earth/ground lead. Clean the battery posts and terminals. Use a wire brush and hot water as required. If hot water is used, follow this with copious amounts of cold water to wash away any acid from the paintwork. Dry the terminals and posts and apply a small amount of battery grease or petroleum jelly. If the battery is not sealed, top up with deionised water to a few millimetres above the plates. Refit the battery and terminals, and ensure they are secure.



Cleaning the battery terminals

Battery State of Charge Check the battery state of charge using a voltmeter or hydrometer. Recharge if necessary OFF the vehicle. If the battery is not in good working order this should be reported to the customer. Many breakdowns are caused by faulty batteries.

General Electrical Service Check the fuse box for security and that spare fuses are fitted. Carry out a general inspection looking for loose connections and damaged wires. This check is looking for potential problems and can save your customer a lot of trouble.

Electrical System Operation Run through ALL the electrical systems in turn to check for correct operation. Make sure that simple items such as the washer fluid bottle are secure and topped up.



Look back over the previous section and write out a list of the key bullet points here:

ELECTRICAL AND ELECTRONIC - CUSTOMER CARE

Introduction Respect your customer's vehicle and take precautions to keep it clean. Repairing or checking some systems, is likely to involve you working under the vehicle, and then sitting in the driver's seat. Use seat covers and ensure the steering wheel is clean when you have finished. Regular servicing is vital for a customer's safety. Carry out checks at all services and report your findings to the customer. Advise customers if anything will need attention before the next scheduled service interval.

Please Don't Touch! You may need to be more tactful but "Don't touch" is often good advice when it comes to electrical and electronic systems. One of our customers fast charged his battery on the car, with a faulty charger, and blew five, yes

five, electronic control units! A little knowledge is a dangerous thing...

Accessories Most modern vehicles come with all the accessories already fitted, which most customers need. However, you may be asked to fit extra items such as spotlights. Make sure you use cables of the correct rating and always fit a relay to take the load from the switch. A 100W bulb, for example, will draw about 8A. A cable with at least 16 strands will be required. A suitable circuit is shown here.

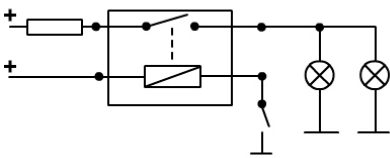

Extra spotlights circuit

System Operation One important task that you may need to carry out is to help your customers understand how to operate some electrical systems. Modern car electrical systems and the associated controls are well designed, but can be daunting to some customers. Even simple systems such as screen heaters may be confusing because they switch off on a timer. Be willing to spend some time with your customers to show them how certain systems operate. It will be appreciated.

ENGINE ELECTRICAL

INTRODUCTION AND BATTERY CONSTRUCTION

Introduction A good supply of electric power is necessary for modern vehicles. The engines require a large current in order to start and many other systems are now electrically powered. Most small vehicles use a 12 V system but it is likely that, in the future, 42 V systems will become standard. This is to provide sufficient power for the ever-increasing range of electrical and electronic accessories.



Alternator and starter

Microprocessors Many components that were once mechanically operated, are now driven by small electric motors and controlled by microprocessors. Total vehicle control, through sensors, electronic control units and actuators, may be common on vehicles sometime in the future.



Window switches

Battery and Charging System Function The main function of the battery and charging system is to provide a source of electric power for all the electrical systems on the vehicle. They must be capable of providing the electric power under all operating conditions.



Charging system

Starting System Function The main function of the starting system is to crank the engine at sufficient speed to begin the internal combustion process. This will then allow the engine to run, and to be fully controlled by the vehicle driver.



Starter system

Lead-Acid Batteries The majority of vehicle batteries are of conventional design, using lead plates in a dilute sulphuric acid electrolyte. This feature leads to the common description of 'lead-acid' batteries. The output from a lead-acid battery is direct current (DC).



Vehicle battery

Battery Chemistry A rechargeable battery is an electrochemical unit that converts an electric current into a modified chemical compound. This chemical reaction can be reversed to release an electric current. The modified chemical compound in the battery stores energy, which is available as electricity when connected to a circuit.

Routine Maintenance Some batteries have open cells that require routine maintenance to the electrolyte level. This usually consists of topping up with distilled water at regular intervals. Most modern lead-acid battery designs have improved plate construction and case design. This, together with precise alternator charge control, allows low maintenance and maintenance free types to be used.



Open cell battery - with removable caps

Battery Construction □□□ A vehicle 12 V battery is made up from six cells. Each lead-acid cell has a nominal voltage of 2.1 V, which gives a value of 12.6 V for a fully charged battery under no load conditions. The six cells are connected in series, internally in the battery, with lead bars. The cells are formed in the battery case and are completely separate from each other.

Battery Cells □□□ Each cell has a set of interleaved positive and negative plates kept apart by porous separators. The separators prevent contact of the plates, which would give an internal short circuit and affect the chemical reaction in the battery cell. The cell plates are supported above the bottom of the case. This leaves a sediment trap below the plates so that any loose material that falls to the bottom does not cause a short circuit between the plates.

Plate Construction The cell plates are formed in a lattice grid of lead-antimony or lead-calcium alloy. The grid carries the active material and acts as the electrical conductor. The active materials are lead peroxide for the positive plate and spongy lead for the negative plate.

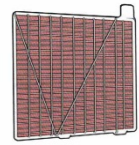

Cell plate construction

Charged Battery When a battery is in a charged state the positive plates of lead peroxide (PbO_2) are reddish brown in colour, and the negative plates of spongy lead (Pb) are grey in colour.



Charged state

Discharged Battery When the battery is discharging a chemical reaction with the electrolyte changes both plates to lead sulphate (PbSO_4).

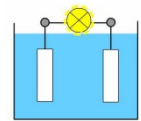

Discharged state

Reversible Chemical Reaction Applying an electric current to the battery reverses the process. The charged battery stores chemical energy. This can be released as electrical energy when the battery is connected into a circuit.

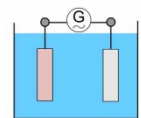

Chemical changes reverse when current is applied

Electrolyte □□□ The electrolyte is dilute sulphuric acid, which reacts with the cell plate material during charging and discharging of the battery. Sulphuric acid (H_2SO_4) consists of hydrogen, sulphur and oxygen. These chemicals separate during the charge and discharge process and attach to the cell plate active material or return to the electrolyte.

Discharging □□□ During discharge, the sulphate (SO_4) combines with the lead to form lead sulphate ($PbSO_4$). The oxygen in the positive plate is released to the electrolyte and combines with the hydrogen that is left, to form water (H_2O).

Charging □□□ During charging, the reverse process occurs with the sulphate (SO_4), leaving the cell plates to reform with the hydrogen in the electrolyte to produce sulphuric acid (H_2SO_4). Oxygen in the electrolyte is released to reform with the positive cell plate material as lead peroxide (PbO_2).

Gassing Near the fully charged state some hydrogen (H) and oxygen (O) is lost as gas from the battery vent. Some water (H_2O) can also be lost by vaporisation in hot weather. On older batteries, this meant that the battery electrolyte needed regular inspection and topping up.

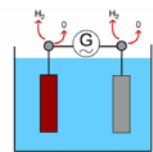



Discharge of hydrogen and oxygen

Topping up the Battery Only water is lost from the battery and therefore only water should be used for topping up. Any contaminants will affect the chemical reactions in the battery and, therefore, the performance. Only distilled or specially produced topping up water should be used. Tap water is not suitable for topping up a battery. Acid should never be used, as this will strengthen the acid solution and alter the chemical reactions.



Water (H_2O) is lost as H and O_2 - only top up with distilled water

 State the chemical make up of a fully charged AND a fully discharged lead-acid battery.

 Look back over the previous section and write out a list of the key bullet points here:

BATTERY CAPACITY AND STATE OF CHARGE

State of Charge The state of charge of a battery can be checked by measuring the strength of the electrolyte. The off-load voltage can also be used. The condition of a battery is measured by its ability to provide a high electric current for a short time (10 seconds), without the voltage falling below a reasonable level.



Hydrometer

Voltmeter

Electrolyte The electrolyte chemical composition changes with the state of charge. It is possible to measure this change using a hydrometer. Sulphuric acid is denser and provides greater buoyancy than water. These properties are called 'specific gravity' or 'relative density', and water, which is used as the base for measurement of all liquids, is given a value of 1 for hydrometer readings at 15°C (60°F).

Relative Density Readings

The dilute sulphuric acid of the electrolyte of a fully charged battery cell has a reading of 1.280. The reading for a half charged battery cell is 1.200 and for a fully discharged battery is 1.150. A reading below 1.140 may indicate a cell that can no longer be recharged. It is common to write these values with three decimal places but to just say the significant digits.



Hydrometer A hydrometer consists of a calibrated float in a glass cylinder. A bulb on the top of the cylinder is depressed so that it acts as a vacuum pump when it is released. A small rubber tube is attached to the bottom of the cylinder and is inserted into the electrolyte in the battery cell. A sample of the electrolyte can, therefore, be drawn into the cylinder.



Construction of a hydrometer

Hydrometer Operation The sample of electrolyte in the hydrometer lifts the float in proportion to the buoyancy of the liquid. The higher it floats the greater its 'relative density'. Calibrated marks on the float align with the top of the liquid to give the actual reading. This is compared with standard data and all cells are compared with each other to check the general condition of the battery. There should be very little difference between the cells.



Reading a hydrometer

Cell Voltages On some batteries, it is possible to compare cell voltages. A fully charged battery has a cell voltage of 2.1 V and a fully discharged cell 1.8 V. Discharging below this level may damage the battery. Where cell voltage cannot be measured, the voltage of the complete battery will indicate battery condition. A fully charged battery will give a reading of 12.6 V and a fully discharged battery 9.8 V. A reading below this level may indicate a faulty cell.



Battery voltages...



Fully charged...



Half charged...



Discharged

Discharge Testing Measurement of battery condition by heavy-duty discharge should only be carried out on a fully charged battery. It is also important to blow gently across the top of the battery to remove any explosive hydrogen gas. Heavy duty discharge is carried out with a specialist item of equipment. The test consists of connecting a resistor in circuit with the battery for about ten seconds and measuring the voltage drop. This test applies a load similar to that of the starter circuit. Generally, the voltage should not fall below 10 V.



Heavy duty discharge test on the vehicle



...On the bench

Battery Capacity □□ Battery 'capacity' is a measure of the rate at which a battery (at a constant temperature of 25°C) can be discharged before its voltage falls to 1.8 V. The usual measure is for constant amperage over a 10 hour period, which is known as the 10 hour rate. In some instances, a 20 hour rate is used. A battery that can discharge at 4 A, over 10 hours, or 2 A, over 20 hours, is said to have a 'capacity' of 40 ampere hours (Ah).

Plates and Surface Area The capacity of a battery is proportional to the number of cell plates and their surface area. Larger plate areas and increased numbers of plates are used to give greater ampere-hour rates.



Cell plates

Ampere Hour Capacity Battery performance is related to the amp/hour rate, but is also affected by the ambient temperature. A cold battery will have a poor performance in comparison to a warm battery.

Reserve Capacity A more useful measure of battery performance is the 'reserve capacity' rating. This refers to the time taken in minutes for a battery to discharge to a cell voltage of 1.75 V - when supplying a constant current of 25 amps. This test reflects a typical current draw for a vehicle that would be needed if the charging system failed during night driving. The reserve capacity for a 40 Ah battery will be approximately 60 minutes.

Cold Cranking Amps  Another measure is the 'cold cranking amps' rating, which is a measure of the maximum current that can be supplied for a period of 30 seconds before the battery voltage falls below 7.2 V. This test is carried out at minus 18°C so that it represents the most severe conditions of cold engine starting. The 'cold-cranking amps' (CCA) rating of a battery is an important measure in regions that suffer very cold winter temperatures.



State the chemical makeup of a fully charged AND a fully discharged lead-acid battery and the voltage readings of a discharged, half charged and fully charged battery cell.



Look back over the previous section and write out a list of the key bullet points here:

Modern Batteries Many modern batteries use a modified plate design that has a centralised plate lug and radial grid construction. To reduce gassing, the grid material is a lead-calcium alloy with a small portion of antimony. This plate design gives improved electric current flow and is lighter than the earlier design. This means that lighter weight batteries are now available with the same performance as the older type.

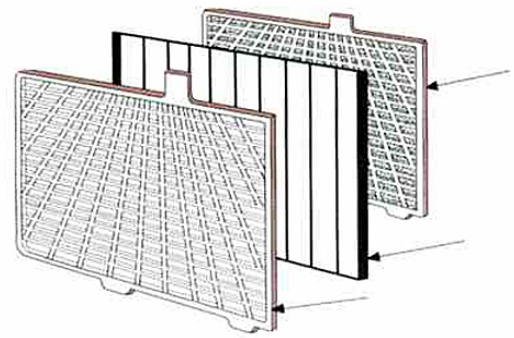

Modern cell plate design

Low Maintenance These batteries are low maintenance or maintenance free types. When used with an alternator, with accurate charge control, they require maintenance either at yearly intervals or never!



Low maintenance battery

Maintenance Free Batteries Maintenance free batteries are completely sealed or have only a very small vent. The maintenance free battery does not lose water from the electrolyte in the same way as conventional lead-acid batteries do. A number of changes in the chemical composition of the plates and in the construction of the battery case reduce gassing to almost zero. Liquid, gas and vapour are also captured and returned to the battery cells.



Sealed
maintenance
free battery

Plate Grids The plate grids are of radial design, made from a lead-calcium alloy, and filled with a high-density active material. The plates are enclosed in chemically inert separator envelopes. At the top of each cell is a liquid and gas separator area with a drain to return any liquid to the cell. The cells are sealed from each other, and the connecting bars are sealed where they pass through the cell partitions.



Construction of
maintenance free
battery

Recombination Battery A further development in maintenance free battery design is the 'recombination battery'. These batteries have all the electrolyte held in micro-porous envelope separators around the plates, which are then pressed together, so that there is no free acid in the cells. In a recombination battery, there is slightly more negative plate material than positive plate material. This allows the oxygen released by the positive plates, near to the fully charged position, to combine with the negative plate material rather than be released as gas. As there is no loss of gas from these batteries, they can be fully sealed.

Built In Hydrometers Some maintenance free batteries incorporate a built in hydrometer to indicate the state of charge and condition of the battery. The hydrometer is colour coded. A green colour indicates that the battery is charged and serviceable. A green-black or black colour indicates that the battery requires recharging. A yellow colour indicates that the battery is faulty. Where a yellow hydrometer is showing, the battery should not be recharged or tested, and the use of jump leads for starting should not be carried out. A new battery should be fitted and the alternator checked for correct operation.



Maintenance free battery hydrometer colours

Fast Charging Maintenance free batteries are not ideally suitable for 'fast charging' or connection to a 'fast-charger' for engine starting. When recharging, they should be disconnected from the vehicle electrical systems and slow-charged, in accordance with the manufacturer's instructions.



Fast charger

Maintenance free battery

Hybrid Battery A hybrid battery, or deep cycle battery, produces a high performance cold cranking amperage. The 'hybrid' design of this type of battery refers to the use of a lead-antimony alloy for the positive plate grids and a lead-calcium alloy for the negative plate grids. This allows the battery to provide a high current for cold starting in very cold conditions, without permanent harm to the battery.



Hybrid battery grid

Need for Extra Charging The state of charge of the battery is maintained on the vehicle by the alternator. The output from the alternator is usually sufficient, but for vehicles used for short journeys or frequent stop-start use, additional charging may be required.



Battery on bench charger

Regular Charging Some batteries, that are not being used regularly, need to be charged at approximately monthly intervals to maintain their charge and condition. Batteries that become fully discharged, or are used continually at a low state of charge, can suffer from sulphation of the plates. This irreversible condition leads eventually to battery failure.



Recharging

Battery Chargers There are two types of off-vehicle charger - the 'bench charger', which has a current output of up to about 10 A, and the 'fast-charger', that can recharge a battery in about thirty minutes, with a current of about 50 A. Not all batteries are suitable for fast charging and reference to the manufacturer's instructions is required before charging any battery.



Bench charger



Fast chargers

Bench Charger The bench charger should be situated in a well-ventilated area of the workshop. Smoking should also be prohibited. The bench top should be resistant to acid and be made from an electrically insulating material.

Charger Operation The charger is connected to the mains electrical system and uses a transformer to reduce to 24, 12 or 6 V depending on the battery voltage. The actual output will be slightly higher than the nominal battery voltage in order to give an effective charge. The charger also includes a rectifier to change the AC (alternating current) mains supply to the DC (direct current) voltage required by the battery.



Bench charger

Voltage Control Bench chargers with voltage control have high initial current outputs, which fall as the battery charges. Chargers with current control can be adjusted to suit individual batteries.



Voltage and current control

Charge Rates The usual rule for battery charging is that the charge current should be set to a tenth of the Ah (ampere hour) rating of the battery. Alternatively, about a sixteenth of the reserve capacity, or a fortieth of the cold cranking amps figure, gives a good guide. A fully discharged battery will take about twelve hours to fully recharge. When recharging partially charged batteries, it is recommended that they should be checked at regular intervals.



Testing a battery on charge

Disconnecting the Charger Always switch off the charger and leave it for about five minutes before disconnecting the leads and carrying out any tests. This is to allow any hydrogen gas to dissipate into the atmosphere, and reduce ignition and fire hazards from accidental sparks. Hydrogen is highly flammable and explosive in an enclosed space such as inside the top of a battery.



Switch off the charger before disconnecting

Fast Chargers Fast chargers are portable items of equipment that will charge a battery in a short space of time. They can often be used for engine starting, depending on design.



Fast charger with engine starting facility

Build Up Of Gas Where possible, the battery tops should be removed during charging to prevent a build-up of gas in the battery case. The area around the battery should be marked as a no smoking area.



Battery caps removed during fast charging



No smoking sign!

Overcharging There is a risk of overcharging and overheating a battery with fast chargers, and, therefore, if a temperature sensor is fitted, it must be used. If a sensor is not fitted, frequent checks should be made to check for gassing and battery temperature. Charging should be stopped when heavy gassing is evident or if the battery feels more than just warm to the touch.



Use of temperature sensor OR check the battery by hand

External Features The external features of a battery are the type and size of the terminal posts, the dimensions of the battery and the method of fixing to the vehicle. The terminal posts are clearly identifiable as positive or negative, by the positive sign (+) and/or red colour, and the negative sign (-) and/or black colour.



Battery features...



...Can vary

Tapered Round Terminal Posts The positive and negative posts, on tapered round terminals, are different sizes. The larger post is the positive one and the smaller is negative. The difference in the sizes is used to minimise the risk of incorrect fitting. There are two size ranges, with a smaller version used by some manufacturers, generally in the far eastern geographical zone, and a larger size used by western European and American manufacturers. These round post terminals have a cast cap type or clamp type cable terminal.



Round battery posts

'L' Terminal Posts Some manufacturers use batteries with a flat, or 'L' terminal on the battery, and a flat terminal on the cable, and a nut and bolt to complete the connection. Some American vehicles use a side terminal, which has an internal thread, and the connection is made with a bolt through a flat terminal on the cable.



Flat posts

Battery Cables Battery cables must have sufficient cross-sectional area to carry the starter motor and electrical systems current. The feed to the starter motor is a heavy duty insulated cable, and the earth or ground cable is of similar construction, or may be a braided strap.



Main supply



Component earth



Body earth



Starter/engine earth



Describe a safe procedure for fast-charging a battery.



Look back over the previous section and write out a list of the key bullet points here:

CHECKING BATTERIES

Introduction The checks covered in this section are basic checks to make sure that the system is performing correctly. The checks will also identify faults if problems are suspected.

Routine Maintenance The battery, starting and charging systems require very little routine maintenance. However, it is important that a general check is made whenever work is being carried out on the vehicle. This general check will only take a few moments and can be included when other checks are being carried out.

Cranking Performance When the engine is being started, it is possible to check the charge warning light operation and listen to the operation of the starter motor. Whenever any fault is suspected, further checks and diagnostic tests should be carried out.



Warning lights

Early Diagnosis □□□ A defective battery or charging system will often lead to a vehicle breakdown. This can be prevented by early diagnosis of a developing problem.



Worksheet Inspect batteries for

condition, security and state of charge. Fast and slow charge batteries.

The battery is one of the most important components on the vehicle. The condition, security and state of charge checks, and the recharging of batteries, need to be carried out carefully.

Batteries are heavy and filled with a corrosive acid. Fire can result from electrical short circuits or from ignition of the gasses that are produced during charging.

Battery Condition Open the bonnet or other cover to see the battery. Look all around the battery to check its general condition. Look at the battery casing for cracks, leaks, abnormal shape and cleanliness.

Battery Security Check the security of the battery on the battery carrier, and the clamps or holding devices. Look around the battery for signs of acid damage or corrosion.



Vehicle battery



This terminal needs cleaning



Battery security clamps

Terminal Corrosion Look at the terminals for corrosion, as this is an indication of acid or vapour escaping from the battery. Where acid has leaked from the battery, or been spilled on the vehicle, it will be necessary to remove the battery and wash the affected areas. Use copious amounts of water for this task. Any damage to the paintwork will also need to be made good.



Check terminals for corrosion



Clean and apply battery grease

Electrolyte Level Remove the cell caps and check the level of the electrolyte. Do not rely on looking through a transparent casing. It is possible for these to stain and give a false impression of the electrolyte level.



Check battery electrolyte level

Hydrometer Test If it is possible, carry out a hydrometer test for relative density before topping up the battery. If necessary, top up with water specially prepared for batteries. Distilled and de-ionised water are recommended. Tap water or rainwater should not be used.



Hydrometer test



Topping up

Terminal Corrosion There is a general recommendation that the battery terminals be checked and cleaned regularly. Naturally occurring lead oxide forms on the surface of the terminals and battery posts. This oxide acts as an insulator and restricts the current flow to, and from the battery. The terminals and the battery posts can be cleaned with abrasive paper or a wire brush.

Secure Contacts A clean, metal-to-metal, and tight joint on battery terminals is necessary for effective electric current flow. To keep terminals clean in service, it is recommended that they should be coated with a petroleum jelly or proprietary battery grease.



Terminals with battery grease

Cable Terminations Check the battery cables for tightness, corrosion and breakage of individual strands of wire, particularly close to the cable terminations. Look closely at the earth, or ground cable connection to the vehicle body.



Checking the battery cables for tightness and condition

Earth Connection If any problems occur at the earth point, it is possible to clean the terminal and the point on the body where the connection is made. Fit an internal star lock washer, on reassembly, in order to make a good electrical joint.



Earth or ground cable

Cables and Connections Finally, make a careful check of all cables connecting the battery to the alternator and the starter motor, and check the condition and tension of the alternator drive belt.



Alternator
cables to
battery



Starter cables

Battery State of Charge The battery state of charge can be checked with a hydrometer or a voltmeter. A hydrometer is an instrument that takes a small quantity of electrolyte from each cell. This lifts a calibrated float to give a reading of the specific gravity (relative density). A rubber bulb on the top of the hydrometer is depressed before the pick up tube is put into the cell. Once the tube is below the electrolyte level, the bulb is released to draw a sample into the hydrometer.

Hydrometer Reading The reading is taken from the float, where it aligns with the surface of the sample. A fully charged battery should have a relative density reading of about 1.280. All cells should be within 0.01 to 0.02 of each other. A partially charged battery should be recharged before carrying out any further tests. Any large variation between cells will indicate defects in individual cells and will usually require replacement of the battery.



Hydrometer readings...



Discharged...



Half charged...



Fully charged

Maintenance Free Batteries Maintenance free batteries, with a built-in hydrometer, show a green dot when charged, a black dot when partially charged and a yellow dot when an internal fault exists. If a yellow dot is visible, do not attempt to charge the battery or connect another battery for jump-starting. Likewise, do not use a fast battery charger with an engine starting facility.



Maintenance free built in hydrometer

Voltage Tests A conventional battery in good condition will have a voltage of 12.6 V or more - when fully charged. A maintenance free battery may be slightly lower on average but not less than 12.6 V. The voltage is checked with a digital voltmeter connected across the battery terminals. Make sure that the polarity of the meter matches the polarity of the battery. The off load and partial load voltages, should not vary by more than 1 V. A partial load can be applied by turning on the vehicle headlamps.



Battery voltage readings...



Discharged...



Half charged...



Fully charged

Discharge Tester A battery heavy discharge test is carried out to check the ability of the battery to provide a high current over a short period. The discharge test draws a very high current. It should therefore, only be carried out on a fully charged battery. The test time is usually about ten seconds. However, the time specified by the individual tester should not be exceeded.



Blow away any hydrogen gas before starting the test



Battery heavy duty discharge test

Discharge Test Settings The setting for discharge can be adjusted on some types of tester. This is usually set at three times the amperage of the ampere-hour rate (Ah) of the battery. The test current for a 40 Ah battery would, therefore, be set to 120 A.



A good battery under test

Test Procedure Connect the test leads or probes firmly across the battery terminals. Switch on or connect the tester for the time specified. During the test, read the voltage from the gauge. Typical readings are between 9 V and 11 V depending upon the capacity of the battery. The voltage should be maintained for the period of the test. Compare with the specifications provided with the equipment. If the battery voltage falls below 9 volts, discontinue the test. This will indicate that the battery is no longer serviceable.



For most car batteries the voltage should hold at 9 or 10 V for 9 or 10 seconds



Look back over the previous section and write out a list of the key bullet points here:

Battery Charging Battery charging should only be carried out in a well-ventilated area specially designated for the purpose. A suitable acid resistant and non-conductive bench is recommended. A face shield, to prevent acid splashes on the face and in the eyes, should be kept close by. Sterile eyewash should also be available for use if acid does splash into the eyes. No smoking signs should be clearly displayed.

Slow and Fast Charging There are two ways of charging batteries in the workshop; one is a slow or trickle charge and the other a fast charge.

These require two different types of charger. Most batteries can be fast charged, but this should only be carried out infrequently. If a high charge is used this can cause some deterioration of the battery active materials.



Bench charger



Fast charger

Charger Operation A slow charger or bench charger uses mains electricity. Inside is fitted a transformer to reduce the voltage to 6, 12 or 24 volts, to suit the battery or batteries on charge. Also fitted is a rectifier to change the AC volts of the mains supply to the DC volts needed for charging batteries. The charger is connected to the battery terminals with the correct polarity. After setting the control switches, the charger is then turned on at the main switch.



Correct
polarity is
important

Charge Rate There are a number of different types of charger and these should be used in accordance with the manufacturer's instructions. The recommended charge rate for a battery is one tenth of the ampere-hour capacity. A 40 Ah battery should be charged at 4 A. If the ampere-hour capacity is not known, set the rate to one sixteenth of the reserve capacity. Where the charge current can be adjusted, this facility should be used to set the rate.

Multiple Battery Charging A number of 12 V batteries can be charged at the same time. However, this should only be done if the charger has the capacity. The batteries should be of similar size and be connected in parallel for a 12 V charge rate or in series for a 24 V charge rate.



Connecting batteries in parallel (12 V)

...



...And series (24 V)

Batteries on Charge Batteries on charge should be checked at regular intervals to watch for progress and to remove them from the charger when they are fully charged. Hydrometer readings are used for this test.



Checking batteries on charge with a hydrometer

Safety First It is important that the charger is switched off before it is disconnected from the battery. For further safety, leave the batteries for about five minutes before the charger leads are disconnected. This will allow any flammable gas to dissipate to the atmosphere.

Fast Charging A fast charger can be connected to a battery on a vehicle, in order to give a quick boost when a battery has a low charge. Some of these chargers have an engine start facility. Always follow the equipment manufacturer's instructions when using this type of charger. Some batteries are not suitable for fast charging and, therefore, always refer to the vehicle or battery manufacturer's data for recommendations.

Fast Charge Rate and Time Fast chargers have a time clock for setting the charger for a fixed charge period. Some have a temperature probe included, to switch off the charger if the battery becomes overheated. Keep a close watch on the battery temperature if a fast charger does not have a temperature probe. The maximum setting for a fast charge should not exceed one hour at five times the normal charge rate.



Look back over the previous section and write out a list of the key bullet points here:

Introduction The abbreviation R&R is short for remove and refit components. Very few specific tools and materials are used exclusively for the battery, starting and charging systems. Where special tools are used, refer to the manufacturer's workshop manuals and data books for precise instructions. The majority of tasks can be completed with general workshop tools and equipment.

Lifting Batteries A clamp for lifting batteries is available and is commonly used in some workshops. This consists of a pair of grip faces arranged below crossing arms. One arm is fitted with a lifting handle and the act of lifting uses the battery weight to clamp the arms together. Be careful when using this lifting tool, making sure that the battery casing is not pushed inwards. This can cause the casing to fracture and the acid to leak out.



Battery lifting clamp tool - Snap-on

Test and Diagnostic Equipment There is a range of meters and specialist test and diagnostic equipment to check components and systems. These are covered in the 'checking system performance' and the 'diagnostic' sections of this learning programme.

Removal of Starters and Alternators The removal and stripping of alternators and starter motors usually requires attention to sequence. It is, therefore, important to follow the manufacturer's instructions when carrying out any tasks. Many replacements are generally straightforward. However, in some cases, exhaust manifolds, or even engines may have to be removed to gain access to alternators or starter motors. Follow the instructions in the appropriate learning programmes when these additional operations are necessary.



Worksheet Remove and refit battery, battery cables

and securing devices.

The first thing to do is to turn off all possible electrical systems including the interior lights. These will stay on if a door is open. The battery is usually fitted in an accessible position in the engine compartment, and removal is a straightforward task.

Memory Saver Where disconnecting the battery may cause a loss of memory in electronic control units, a 'memory saver' battery pack can be connected through the cigarette lighter socket.



Fitting a memory saver

Battery Cables Always undo and remove the battery earth or ground cable first. This is the negative terminal on modern vehicles. Some very old vehicles have a positive earth or ground. Disconnect the positive cable and tuck the cables out of the way of the battery.

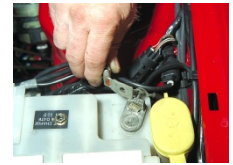

Removing the earth lead

Battery Terminals Whenever undoing a battery terminal bolt always support the terminal in order to prevent the battery post taking the force. Clamp type terminals can be undone and eased apart with a screwdriver or pulled off with a small puller.



Undoing the battery terminal



Removing a clamp type terminal

Battery Clamps Undo and remove the battery clamp. Some batteries are fitted with a hold down clamp on the base of the casing. The clamp should be undone and removed so that the battery can be pulled over to release the other side. Where a bar is fitted to the top of the battery, and held in place by two threaded rods, be careful that the clamp does not make contact with the battery terminals. A short circuit across the battery terminals may cause an explosive situation.

Battery Removal Lift the battery from the carrier using a safe lifting technique. Using equipment that is appropriate to the weight of the battery may be the best method. Some batteries can be heavy and awkward to lift so it is important to be aware of the weight. The route of removal to a safe resting place off the vehicle should also be considered.

Caution! Do not allow the battery to tilt too far from the horizontal as this may lead to acid spillage. If acid is spilled, rinse the affected area with plenty of water.

Battery Tray The battery carrier and under battery tray should be checked for corrosion and security. There is often a drain tube fitted to the tray and this should be checked to make sure that it is not blocked.



Match details when replacing battery



Checking battery carrier

Battery Replacement Replacement is a reversal of the removal process. When fitting a replacement battery ensure that the ampere-hour rate, the external dimensions and the position of the terminals are correct. Look carefully for polarity when checking the terminal positions. Check that the battery is secure and do not over tighten the battery clamp.

New Battery Cables New battery cables can be bought as complete components or they can be made up from cable terminals. All replacement cables should have the same, or more wire strands, of similar cross-sectional area, than the original. In all cases, it must not be less than the specification for the vehicle.

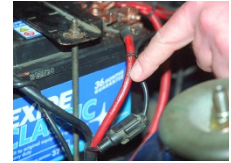

Battery cables

Reconnecting the Battery ☐☐ When reconnecting the battery cables, fit the feed cable first and the earth, or ground cable last. Check that no short circuit exists by touching the earth terminal to the battery and observing for arcing. A very small arc may be visible when a clock or permanent supply is reconnected.

Arcing Any large arcing should be investigated before the battery is finally connected and the terminals tightened. Finally, coat the battery terminals with petroleum jelly.



Look back over the previous section and write out a list of the key bullet points here:

SERVICING AND ROUTINE REPAIRS

Servicing Requirements Scheduled service requirements for the battery, starting and charging systems consist of checks on the performance and operation of the systems. These are quick checks based on the inspections described in the Checking System Performance section. The full checks are not required unless a fault is suspected.



Battery, starting and charging components

Manufacturer's Data Obtain data from the vehicle manufacturer's service schedules for the work to be carried out, at the mileage or time interval, at the time of the service operation.

Drive Belt The only item for routine replacement is the alternator drive belt, if it begins to show signs of deterioration. A preventative maintenance programme would include replacement of the alternator brushes at 60,000 mile intervals. This is a general recommendation given by some vehicle or electrical equipment manufacturers.



Replacing a cam belt



Alternator drive belt

Reporting Faults Report any faults found during service operations to the owner or driver of the vehicle.



Worksheet Routine maintenance inspections,

lubrication and replacement of parts.

This inspection starts as soon the engine is started in order that the vehicle can be driven into the workshop. Observe the ignition/generator warning light for correct operation. Check that it comes on when the ignition switch is turned to the on position and that it goes out, and stays out, when the engine is running. Look very closely for a dull light when the engine is revved, which may indicate an internal fault with the alternator.

Starter Motor Operation Listen to the starter motor operation to check both the battery performance and the starter motor and circuit operation. Listen carefully for abnormal noises such as gears grating, uneven operation or sluggish performance. Any of these faults will require further investigation in the workshop.



Listen to the starter motor

Electrolyte Level In the workshop open the bonnet and look closely at the battery for electrolyte level and, if necessary, top up with distilled water. Check the battery casing for leaks and the battery for security, both at the battery carrier to battery clamps, and the battery carrier to the vehicle.

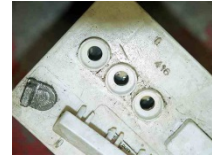

Battery electrolyte level



Level marking

Battery Terminals and Cable

Terminals Battery terminals and cable terminals are inspected for corrosion, tightness and the condition of the cable where it enters the terminal. Corrosion of the battery and cable terminals occurs when battery acid or acid vapour contaminates the terminals. The corrosion appears as a grey green coating of the terminal and surrounding area.



Battery terminals should be...



Clean...



Secure...



And tight

Corrosion on the Battery Terminals All corrosion on the battery terminals and surrounding area should be cleaned off using a baking soda and water solution. The terminal contact faces should be cleaned with a wire brush or abrasive paper. After reconnection, the terminals should be coated with petroleum jelly or a proprietary brand of anti-corrosion gel.

Alternator Drive Belt Check the alternator drive belt for condition and tension. Look for aging, perishing, frays and polishing of the belt and pulley sides. Adjustment should be to the manufacturer's specifications. As a rule, this allows a free play of about half an inch, or 12 mm, on the longest section.

Cable Condition Look carefully at the electric cables for the alternator and the starter motor for security, condition and routing.

Alternator Noises ☐☐ Run the engine and listen for abnormal noises from the alternator. A whine or screech would indicate bearing wear, misalignment of the rotor spindle or a loose drive belt.



Worksheet Check battery and charge circuit

operation for winter usage of vehicle.

These checks have been covered in the Checking System Performance and each of the checks for the battery, starting and charging systems should be carried out. These procedures need to be carried out carefully in order to ensure satisfactory performance during the most arduous of climatic conditions.



Look back over the previous section and write out a list of the key bullet points here:

BATTERY, STARTING AND CHARGING - CUSTOMER CARE

Customer Care The most important objective for customer care is to be particularly careful when checking the battery condition. Inspecting and cleaning the battery terminals during a pre-winter service operation is also important. The drain on a battery is most severe during the cold winter months.

Drive Belt Checks Advise customers that it is important for them to look carefully at the alternator drive belt regularly. During the winter, when very cold temperatures are experienced, it is possible for an old drive belt to 'freeze' and become brittle. The tell-tale signs, before failure of the belt, are cracks and frays in the fabric. If these are seen, it is essential to have the drive belt replaced as soon as possible.

Charge Warning Light  Draw customers' attention to the charge warning light and explain that it not only a warning that the ignition is 'on', but also a main part of the battery charging circuit. If they understand this function of the warning light,

they will realise how important it is to bring the vehicle to the workshop, should any problems with this light develop. This action could avoid a discharged battery and non-starting problems.

LIGHTING AND INDICATORS

LIGHTING SYSTEMS

Introduction Vehicle lighting systems are very important, particularly where road safety is concerned. If headlights were suddenly to fail at night and at high speed, the result could be serious. Remember, that lights are to see with, and to be seen by...

Lighting Clusters Lights are arranged on a vehicle to meet legal requirements and to look good. Headlights, sidelights and indicators are often combined on the front. Taillights, stoplights, reverse lights, and indicators are often combined at the rear.



Lights...



Are positioned...



In different ways by...



Different manufacturers

Bulbs The number, shape and size of bulbs used on vehicles is increasing all the time. A common selection is shown here. Most bulbs used for vehicle lighting are generally either conventional tungsten filament bulbs or tungsten halogen.



Selection of bulbs

Conventional Bulbs In the conventional bulb, the tungsten filament is heated to incandescence by an electric current. The temperature reaches about 2300°C . Tungsten, or an alloy of tungsten, is ideal for use as filaments for electric light bulbs. The filament is normally wound into a 'spiralled spiral' to allow a suitable length of thin wire in a small space, and to provide some mechanical strength.

Tungsten Halogen Bulbs Almost all vehicles now use tungsten halogen bulbs for the headlights. The bulb will not blacken and therefore, has a long life. In normal gas bulbs, about 10% of the filament metal evaporates. This is deposited on the bulb wall. Design features of the tungsten halogen bulb prevent deposition. The gas in halogen bulbs is mostly iodine. The glass envelope is made from fused silicon or quartz.



Headlight bulb

Headlight Reflectors The object of the headlight reflector is to direct the random light rays produced by the bulb into a beam of concentrated light, by applying the laws of reflection. Bulb filament position relative to the reflector is important, if the desired beam direction and shape are to be obtained.



Reflector

Reflector Construction A reflector is a layer of silver, chrome or aluminium deposited on a smooth and polished surface such as brass or glass. Consider a mirror reflector that 'caves in' this is called a concave reflector. The centre point on the reflector is called the pole, and a line drawn perpendicular to the surface from the pole is known as the principal axis.

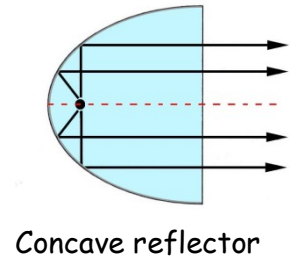

Focused Beam If a light source is moved along the principal axis, a point will be found where the radiating light produces a reflected beam parallel to the axis. This point is known as the focal point, and its distance from the pole is known as the focal length.

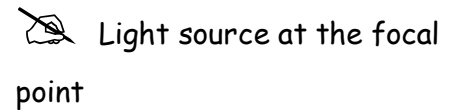

Divergent and Convergent Beams

If the filament is between the focal point and the reflector, the reflected beam will diverge - that is, spread outwards along the principle axis. If the filament is positioned in front of the focal point, the reflected beam will converge towards the principle axis.

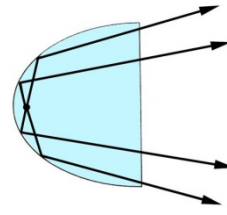

Light source behind the focal point

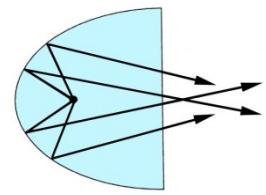

Light source in front of the focal point

Asymmetric Headlights □□□ The intensity of reflected light is strongest near the beam axis, except for the light cut off by the bulb itself. The intensity, therefore, dropping off towards the outer edges of the beam. A common type of reflector and bulb arrangement is shown here, where the dip filament is shielded. This gives a nice sharp cut-off line when on dip beam. It is used with asymmetric headlights.

Headlight Lenses A good headlight should have a powerful far-reaching central beam, around which the light is distributed both horizontally and vertically in order to illuminate as great an area of the road surface as possible. The beam formation can be considerably improved by passing the reflected light rays through a transparent block of lenses. It is the function of the lenses to partially redistribute the reflected light beam and any stray light rays. This gives better overall road illumination.

Lenses Lenses work on the principle of refraction. The headlight front cover is the lens. It is divided up into a large number of small rectangular zones, each zone being formed optically in the shape of a concave flute or a combination of flute and prisms. Each individual lens element will redirect the light rays to obtain an improved overall light projection or beam pattern

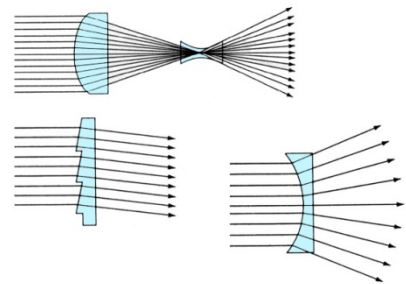

Headlight lens details

Complex Shape Reflectors Many headlights are now made with clear lenses, which means that all the direction of the light is achieved by the reflector. The clear lens does not restrict the light in any way. This makes the headlights more efficient as well as attractive.



Modern headlights

Other Lights Sidelights, taillights, brake lights and others are relatively straightforward. Headlights present the most problems. This is because on dipped beam, they must provide adequate light for the driver, but not by dazzling other road users.



Rear lights

Headlight Alignment The conflict between seeing and dazzling is very difficult to overcome. One of the latest developments, UV lighting, which is discussed later, shows some promise. The main requirement is that headlight alignment must be set correctly.



Beam setter in use

Headlamp Levelling □□□ The function of a levelling actuator is to adjust the dipped or low beam in accordance with the load carried by the car. This will avoid dazzling oncoming traffic. Manual electric levelling actuators are connected up to a control on the dashboard. This allows the driver to adjust beam height.

Automatic Headlight Levelling □□□ Automatic static actuators adjust beam height to the optimum position in line with vehicle load conditions. The system includes two sensors (front and rear), which measure the attitude of the vehicle. An electronic module converts data from the sensors and drives two electric gear motors (or actuators) located at the rear of the headlamps, which are mechanically attached to the reflectors.



Look back over the previous section and write out a list of the key bullet points here:

STOPLIGHTS AND REVERSE LIGHTS

Introduction Stoplights, or brake lights, are used to warn drivers behind that you are slowing down or stopping. Reverse lights warn other drivers that you are reversing, or intend to reverse. The circuits are quite simple. One switch in each case operates two or three bulbs. A relay may be used.



Stop and reverse lights form part of the rear light cluster

Stoptlights and Reverse Lights □□□ The circuits for these two systems are similar. Shown here is a typical stoplight or reverse light circuit. Most incorporate a relay to switch on the lights, which is in turn operated by a spring-loaded switch on the brake pedal or gearbox. Links from the stoplight circuit to the cruise control system may be found. This is to cause the cruise control to switch off as the brakes are operated. A link may also be made to the antilock brake system.

Switches The circuits are operated by the appropriate switch. The reverse switch is part of the gearbox or gear change linkage. The stop switch is usually fitted so it acts on the brake pedal.

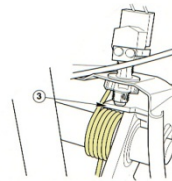

Stoptlight switch

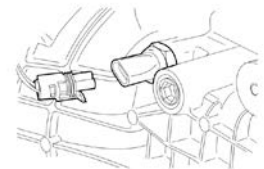

Reverse light switch

A Real Lighting Circuit □□□ The diagram shown is the complete lighting circuit of a vehicle. The colour codes used are discussed in the basic electrical learning sections. However, you can follow the circuit by looking for the labels on the wires. 'N' for example, means 'Brown' but this has no effect on how it works! Operation of part of this circuit is as described over the following screens.

Reverse Lights □□□ The ignition must be on for these lights to operate. The reverse light switch gets its feed from fuse 16 on the GY wire. When the switch is operated, the supply is sent to the rear lamps on a GN wire. The switch is usually mounted on the gear change linkage or screwed into the gearbox.

Stoptlights □□□ The ignition must be on for these lights to operate. The brake or stoplight switch gets its feed from fuse 16 on the GY wire. When the switch is operated, the supply is sent to the rear lamps on a GP wire. A connection is also made to the centre high mounted stoplight. The switch is usually mounted on the pedal box above the brake pedal.

Light Emitting Diodes Light emitting diodes (LEDs) are more expensive than bulbs. However, the potential savings in design costs due to long life, sealed units being used and greater freedom of design, could outweigh the extra expense. LEDs are ideal for stoplights.



Brake light using LEDs

Enhanced Safety □□□ A further advantage is that they illuminate quicker than ordinary bulbs. This time is approximately the difference between 130mS for the LEDs, and 200mS for bulbs. If this is related to a vehicle brake light at motorway speeds, then the increased reaction time equates to about a car length. This is potentially a major contribution to road safety.

Centre High Mounted Stop Lamps An LED centre high mounted stop lamp (CHMSL) illuminates faster than conventional incandescent lamps, improving driver response time and providing extra braking distance. Due to their low height and reduced depth, LED CHMSLs can be easily harmonised with all vehicle designs. They can be mounted inside or integrated into the exterior body or spoiler.



CHMSL

Summary Reverse lights are operated by a simple on/off gearbox switch. Stoplights are operated by a simple on/off switch on the pedal box. Both circuits operate in much the same way. High mounted stoplights are now quite common, many of these using LEDs.

 State TWO advantages of an LED centre high mounted stop lamp (CHMSL).

 Make a sketch to show a brake light circuit using a relay.

 Look back over the previous section and write out a list of the key bullet points here:

INTERIOR LIGHTING

Introduction Interior lighting consists of several systems. The main ones being courtesy lights, map lights and panel illumination lights. The circuits are quite simple, however, they are often linked with the central locking system. Features such as delay and fade out are now common. This requires some electronic control.

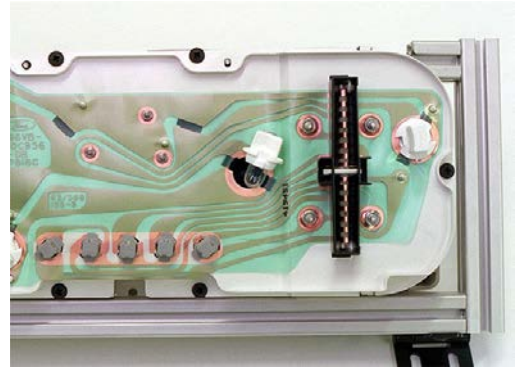

Instrument illumination

Map Light Map lights are an extra feature to assist with reading a map in the dark! Many types are available. Some are small spotlights, which form part of the interior light assembly. Others are positioned on the centre console of the vehicle.

Interior or Courtesy Lights

Lights are designed to illuminate the vehicle interior when the doors are opened. Most cars have one central interior light above the rear view mirror, or two lights, on the sides above the driver's and passenger's shoulders.

 Switch positions

Door Switches Door switches are simple spring-loaded contacts that are made as the door opens. The contacts are broken again as the door closes. Rubber seals are sometimes used to keep water out. The same switches may also be used for the alarm system.



Switch positioned in the door pillar

Interior Light Circuit

The circuit shown here is typical of many in common use. The sliding switches have three positions, 'off', 'on' and 'door operated'. The control module is to allow delay operation. In this case, it is also used for the central locking system.

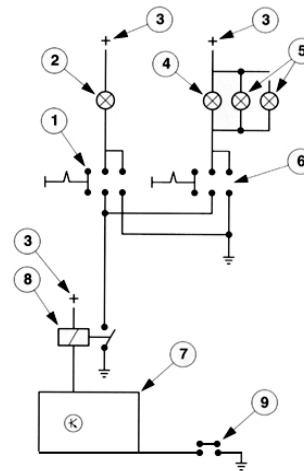

Circuit for interior lights

Instrument and Panel Illumination Panel and instrument lights are illuminated when the vehicle sidelights are switched on. Most cars also incorporate a dimmer switch so the level of illumination can be set.

Central Control Module Ford, now fit a general electronic module (GEM), which controls the interior lights as well as a number of other functions. The interior lights are controlled to prevent them being left on and with a delay timer. On this system the lights are illuminated when a door is opened and the ignition is in position 0 or I. They are extinguished twenty five seconds after a door is closed,

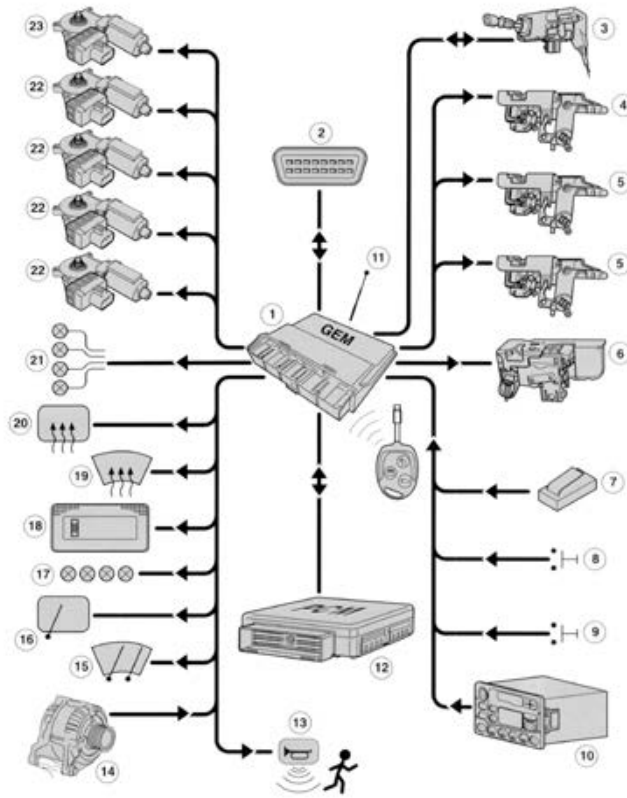

General electronic module (GEM) system

when the car is locked or the

Summary Interior lights are important for passenger comfort. Most now operate via some type of electronic control. One enhancement is a switching off delay, after the doors are closed. Some manufacturers are linking functions such as interior lights, with other systems, by a central control module.



State TWO ways in which interior lights are switched on.



Look back over the previous section and write out a list of the key bullet points here:

TOOLS AND EQUIPMENT

Introduction Components will usually be removed, inspected and repaired or replaced when a defect has been diagnosed. Other components are replaced, or stripped and cleaned, at scheduled mileage or time intervals. Refer to the Routine Maintenance section for details on these items.

Recommended Procedures The descriptions provided in this section deal with the components for individual replacement, rather than as a part of other work. Always refer to a workshop manual before starting work. You will also need to look for the recommended procedure, special tools, materials, tightening sequences and torque settings. Some general and specific tools and pieces of equipment are described on the following screens.

General Toolkit General tools and equipment will be required for most tasks. As your career develops you will build a collection of tools and equipment. Look after your tools and they will look after you!

Torque Wrench A good torque wrench is an essential piece of equipment. Many types are available but all work on a similar principle. Most are set by adjusting a screwed cylinder, which forms part of the handle. An important point to remember is that, as with any measuring tool, regular calibration is essential to ensure it remains accurate.



A torque wrench is a useful tool

Air Guns □□□ The whole point of power tools is that they do the work so you don't have to! Most air guns have an aluminium housing. This material is lightweight but gives long life. Air guns produce a 'hammer' action. Because of this, impact sockets should be used. Normal sockets can shatter under this load. It is important to remember that air tools need lubricating from time to time.

Jacks and Stands Most jacks are simple hydraulic devices. Remember to make sure the safe working load (SWL) is not exceeded. Ensure that any faults with equipment such as this are reported immediately. Axle stands must always be placed under the vehicle supporting the weight - before work is carried out.



Always use stands...



After jacking a vehicle

Ramps and Hoists Many ramps are available ranging from large four-post wheel-free types to smaller single-post lifts. These large items should be inspected regularly to ensure they are safe.

Transmission Jack If a complete gearbox has to be removed, it is likely to be heavy! A transmission jack has attachments that allow you to support the gearbox and lower it safely. The equipment is hydraulically operated just like an ordinary jack. Often, the height can be set by using a foot pedal, which leaves both hands free for positioning the unit.



This jack will support a gearbox

Bearing Puller Removing some bearings is difficult without a proper puller. For internal bearings, the tool has small legs and feet that hook under the bearing. A threaded section is tightened to pull out the bearing. External pullers hook over the outside of the bearing and a screwed thread is tightened against the shaft.



Internal bearing puller



External bearing puller

Air Ratchet These tools are very useful for removing or fitting nuts and bolts. However, it is possible to over tighten if care is not taken. Air tools can be very powerful and will trap your hands! Take adequate precautions at all times.



These tools are very useful

Headlamp Beam Setter Correct beam alignment is a legal requirement; it is also necessary for efficient operation of vehicle headlights. Many types of beam setting equipment are available and most work on the same principle. The method is the same as using an aiming board but is more convenient and accurate due to easier working and less room required. A lens at the front collects light and a mirror reflects the beam pattern onto a small screen.



Alignment equipment



Look back over the previous section and write out a list of the key bullet points here:

Scheduled Servicing Scheduled service requirements are often quite simple but none-the-less important. Systems should be checked for correct operation. Adjustments, repairs or replacements are then made if required.

Non-Routine Work When carrying out routine maintenance, some non-routine work may be found. This should be reported to the driver or owner of the vehicle before repairs are carried out.



Worksheet Check all vehicle lights for

correct operation.

This is a simple check carried out as part of all services. However, it is a vital safety aspect. Check lights for correct operation, colour and flash rate where appropriate. Indicators should flash between 60 and 120 times per minute.

Lighting Operation It is necessary to use an assistant when checking lights - or carefully positioned mirrors! It will be necessary to switch the ignition on for some of the lights to operate. Remember to check instrument and interior lights.



Indicators
operating



Headlights

Lighting Colours Regulations relating to different light colours vary in different parts of the world. However, most are similar and are summarised as follows:

- Headlights - white, yellow, blue/white
- Indicators - amber (UK), red/amber (US)
- Sidelights - white
- Rear lights - red
- Stoplights - red
- Reverse lights - white.

Type of Light The type of light emitted is either described as a beam or diffused. Headlights and auxiliary lights emit beams. All other exterior lights emit diffused, or non-focussed, light. This is to prevent other road users being dazzled.



Spotlight



Worksheet Check all vehicle lights for condition and

security.

As well as operating correctly, vehicle lights must be secure, clean and in good condition. Lenses should be free from cracks and damage. Reflectors should be clean and free from corrosion.

Headlights Cracks in the lens of a headlight or corrosion of the reflector, can cause a disruption to the beam emitted. In some countries, any crack makes the lights illegal. However, in the UK for example, the lights can fail the annual MOT test for a cracked lens, but only if the beam is adversely affected. Generally, corrosion will prevent correct operation and the reflector of the light unit should be renewed.



Damaged headlight lens

Rear lights No white light should be emitted from the rear of a vehicle except when reversing or intending to reverse. Check carefully for cracks in the lenses of all the rear lights.



Damaged rear light lens

Summary Safety of all road users and pedestrians is essential. Reliable operation of the vehicle is also important. The condition of all systems is therefore vital. Carry out a check at all service intervals.



Look back over the previous section and write out a list of the key bullet points here:

LIGHTING - CUSTOMER CARE

Regular Checks Regular servicing is vital for a customer's safety. Carry out checks at all services and report your findings to the customer. Advise customers if anything will need attention before the next scheduled service interval.

Vehicle Condition Respect your customer's vehicle and take precautions to keep it clean. Repairing or checking some systems, is likely to involve you working under the vehicle, and then sitting in the driver's seat. Use seat covers and ensure the steering wheel is clean when you have finished.

Lighting Make sure that all the lights operate correctly when you check a customer's vehicle. Pay attention to details such as panel lights or instrument lights. Even a simple fault, such as a blown instrument illumination bulb, is very important.

Light units Some light units can be very expensive. Headlights in particular can be damaged by flying stones when the car is moving. Some manufacturers supply protective covers that fit over the front lights. If your customer uses the vehicle in off road conditions, he or she may appreciate advice about light covers.



Headlight units can be very expensive

Adjustments A correctly adjusted headlight beam pattern will ensure that your customer's lights will be operating to their best performance. The methods for adjusting headlight alignment are covered in the Component Inspection and Repair section.

Summary A customer who is kept informed and treated with respect will return and keep you in a job! Explain things to a customer when asked - it will be appreciated.

BODY ELECTRICAL AND ELECTRONIC SYSTEMS

WASHERS, WIPERS AND HEATED SCREENS

Windscreen Washers and Wipers □□□ The requirements of the wiper system are simple. The windscreen must be clean enough to provide suitable visibility at all times. To do this the wiper system must meet the following requirements:

Efficient removal of water and snow

Efficient removal of dirt

Operate at temperatures from -30 to 80°C

Pass the stall and snow load test

Have a service life in the region of 1.5 million wipe cycles

Be resistant to corrosion from acid, alkali and ozone.

Wiper Blades Wiper blades are made of a rubber compound and are held on to the screen by a spring in the wiper arm. The aerodynamic property of the wiper blades has become increasingly important. The strip on top of the rubber element is often perforated to reduce air drag. A good quality blade will have a contact width of about 0.1mm. The lip wipes the surface of the screen at an angle of about 45 degrees. The pressure of the blade on the screen is also important.

Wiper Linkages □□ Most wiper linkages consist of a series or parallel mechanism. Some older types use a flexible rack and wheel boxes similar to the operating mechanism of many sunroofs. One of the main considerations for the design of a wiper linkage is the point at which the blades must reverse. This is because of the high forces on the motor and linkage at this time. If the reverse point is set so that the linkage is at its maximum force transmission angle, then the reverse action of the blades puts less strain on the system. This also ensures smoother operation.

Wiper Motors All modern wiper motors are permanent magnet types. The drive is taken via a worm gear to increase torque and reduce speed. Three brushes may be used to allow two-speed operation. The normal speed operates through two brushes placed in the usual positions opposite to each other. For a fast speed, the third brush is placed closer to the earth brush. This reduces the number of armature windings between them, which reduces resistance, hence increasing current and therefore speed.



Motor brushes and armature

Circuit Protection Wiper motors or the associated circuit must have some kind of short circuit protection. This is to protect the motor in the event of stalling, if frozen to the screen for example. A thermal trip of some type is often used or a current sensing circuit in the wiper ECU if fitted.



Wipers frozen on the screen

Windscreen Washers The windscreen washer system consists of a simple DC permanent magnet motor, which drives a centrifugal water pump. The water, preferably with a cleaning additive, is directed onto an appropriate part of the screen by two or more jets. A non-return valve is often fitted in the line to the jets to prevent water siphoning back to the tank. This also allows 'instant' operation when the washer button is pressed. The washer circuit is normally linked in to the wiper circuit, such that when the washers are operated, the wipers start automatically and will continue, for several more sweeps, after the washers have stopped.

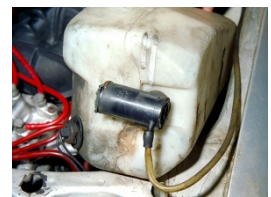

Washer motor

Washer and Wiper Circuits Shown here is a circuit for fast, slow and intermittent wiper control. The switches are shown in the off position and the motor is stopped and in its park position. Note that the two main brushes of the motor are connected together via the limit switch, delay unit contacts and the wiper switch. This causes regenerative braking because of the current, generated by the motor due to its momentum, after the power is switched off. Being connected to a very low resistance loads up the

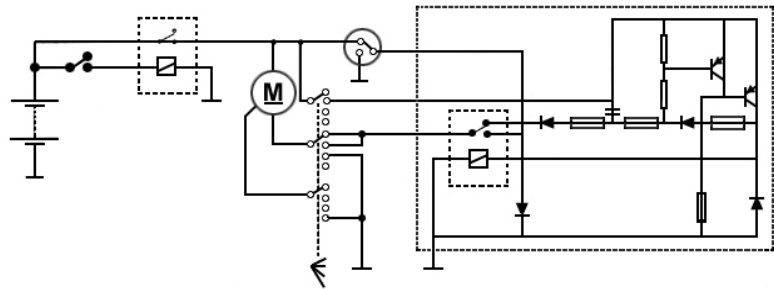

Wiper circuit

'motor/generator'

and, when the park limit switch closes it

Operation of the Circuit □□□ When either the delay contacts or the main switch contacts are operated, the motor will run at slow speed. When fast speed is selected, the third brush on the motor is used. On switching off, the motor will continue to run until the park limit switch changes over to the position shown. This switch is only in the position shown when the blades are in the parked position.

Central Control Units Some vehicles use a system with more enhanced facilities. This is regulated, by what may be known as, a central control unit (CCU), a multi-function unit (MFU) or a general electronic module (GEM)! These units often control other systems as well as the wipers, thus allowing reduced wiring bulk under the dash area. Electric windows, headlights and heated rear window to name just a few, are now often controlled by a central unit

Wiper Blade Pressure Control A

system called wiper pressure control, can infinitely vary the pressure of the blade onto the screen, depending on vehicle speed. At high speeds, the air stream can cause the blades to lift and judder. This seriously reduces the cleaning effectiveness. If the original pressure is set to compensate, the pressure at rest could deform the arms and blades. Sensors are used to determine the air stream velocity and intensity of the rain. An ECU then evaluates the data from these sensors and passes an appropriate signal to a servomotor. When the blades are in the rest position pressure is very low to avoid damage. The pressure rises with increasing vehicle speed and heavy rain.

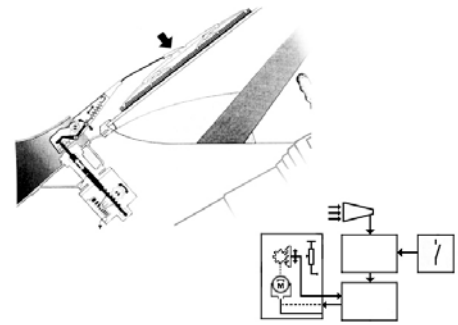

Bosch pressure control system

Linear Rear Wipers Current wiper systems that are based on an alternative rotary movement cover a wipe area, of between 50% and 60%, of the total surface area of the rear window. This limit is due to the height/width ratio and the curve of the window. The linear rear wiper concept ensures optimum visual comfort as it covers over 80% of the rear window surface. This increase in the driver's field of vision enhances safety especially during low speed manoeuvres such as reversing or parking.

Rear Screen Heating Heating of the rear screen involves a circuit with a relay, which will usually incorporate a timer. The heating elements are thin metallic strips bonded to, or built inside the glass. When a current is passed through the elements, heat is generated and the window will defrost or demist.

Windscreen Heating Front windscreen heating is used on some vehicles. This presents more problems than the rear screen, as vision must not be obscured. The technology used, is drawn from the aircraft industry; it involves very thin wires cast in to the glass. As with the heated rear window this device can consume a large current and uses a timer relay.

High Current Screen heaters can draw high current, 10 to 15 amps being typical. Because of this, the circuits often contain timer relays to prevent the heaters being left on too long. The timer will switch off after 10 to 15 minutes.



Timer relay



Look back over the previous section and write out a list of the key bullet points here:

HORNS, OBSTACLE AVOIDANCE AND CRUISE CONTROL

Electric Horns Regulations in most countries state that the horn (or audible warning device) should produce a uniform sound. This makes sirens and melody type fanfare horns illegal! Most horns draw a large current so are switched by a relay.

Horn Circuit The standard horn operates by simple electromagnetic switching. Current flow causes an armature, which is attached to a tone disc, to be attracted to a stop. A set of contacts is then opened. This disconnects the current allowing the armature and disc to return under spring tension. The whole process keeps repeating when the horn switch is on. The frequency of movement, and hence the tone, is arranged to lie between 1.8 and 3.5kHz. This note gives good penetration through traffic noise.

 Horn operation circuit

Twin Horns Twin horn systems, which have a high and low tone horn, are often used. This produces a more pleasing sound, but is still very audible in both town and higher speed conditions.



Horns removed from vehicle

Obstacle Avoidance Radar This system sometimes called collision avoidance radar can be looked at in two ways. First, as an aid to reversing, which gives the driver some indication as to how much space is behind the car. Second, collision avoidance radar can be used as a vision enhancement system. Obstacle avoidance radar when used as a vision enhancement is somewhat different. Shown here is a block diagram to demonstrate the principle of this system. In the future, this may be linked with adaptive cruise control.

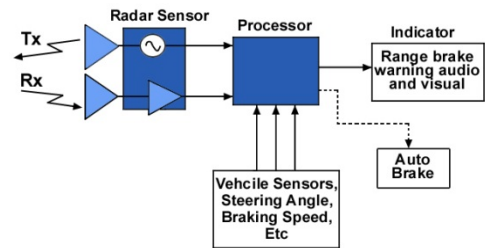

System block diagram

Reversing Aid The principle of radar as a reversing aid is illustrated here. This technique is in effect a range finding system. The output can be audio or visual, the latter being perhaps most appropriate, as the driver is likely to be looking backwards. The audible signal is a 'pip pip pip' type sound, the repetition frequency of which increases as the car comes nearer to the obstruction becoming almost continuous as impact is imminent. The technique is relatively simple as the level of discrimination required is low and the radar only has to operate over short distances. The main problem is to ensure the whole width of the vehicle is protected.



Ultrasonic reversing aid

Cruise Control Cruise control is the ideal example of a closed loop control system. The purpose of cruise control is to allow the driver to set the vehicle speed and let the system maintain it automatically.

Speed Control The system reacts to the measured speed of the vehicle and adjusts the throttle accordingly. The reaction time is important so that the vehicle's speed does not feel to be surging up and down. Other facilities are included such as allowing the speed to be gradually increased or decreased at the touch of a button. Most systems also remember the last set speed. They will resume to this speed, at the touch of a button.



Throttle controller

System Description The main switch switches on the cruise control, this in turn is ignition controlled. Most systems do not retain the speed setting in memory when the main switch has been turned off. Operating the 'set' switch programs the memory, but, this normally will only work if conditions similar to the following are met:



Cruise control switch

Vehicle speed is greater than 40km/h

Vehicle speed is less than 120km/h

Change of speed is less than 8km/h/s

Automatics must be in 'drive'

Brakes or clutch are not being operated

Engine speed is stable.

Set and Resume Once the system is set, the speed is maintained to within about 3-4 km/h until it is deactivated by pressing the brake or clutch pedal, pressing the resume switch or turning off the main control switch. The last set speed is retained in memory except when the main switch is turned off. If the cruise control system is required again then either the set button will hold the vehicle at its current speed or the resume button will accelerate the vehicle to the previous set speed. When cruising at a set speed, the driver can press and hold the set button to accelerate the vehicle until the desired speed is reached. If the driver accelerates from the set speed to overtake for example, then when the throttle is released, the vehicle will slow down again.



Cruise control switches

Control Methods A number of methods are used to control the throttle position. Vehicles fitted with drive by wire systems allow the cruise control to operate the same actuator. A motor can be used to control the throttle cable or in many cases, a vacuum operated diaphragm is used, which three simple valves control.



Throttle motor

Vacuum Actuator □□□ When the speed needs to be increased valve 'x' is opened allowing low pressure from the inlet manifold to one side of the diaphragm. The atmospheric pressure on the other side will move the diaphragm and hence the throttle. To move the other way valve 'x' is closed and valve 'y' is opened allowing atmospheric pressure to enter the chamber. The spring moves the diaphragm back. If both valves are closed then the throttle position is held. Valve 'x' is normally closed and valve 'y' normally open. In the event of electrical failure, cruise will not remain engaged and the manifold vacuum is not disturbed. Valve 'z' provides extra safety; it is controlled by the brake and clutch pedals.

Safety Switches The brake switch is very important, as it would be dangerous braking if the cruise control system was still trying to maintain the vehicle speed. This switch is normally of superior quality and is fitted in place or as a supplement to the brake light switch activated by the brake pedal. Adjustment of this switch is important. The clutch switch is fitted in a similar manner to the brake switch. It deactivates the cruise system to prevent the engine speed increasing if the clutch is pressed. The automatic gearbox switch will only allow the cruise to be engaged when it is in the 'drive' position. This is to prevent the engine over speeding if the cruise tried to accelerate to a high road speed with the gear selector in position '1' or '2'.

Speed Sensor This will often be the same sensor that is used for the speedometer. If not several types are available, the most common producing a pulsed signal the frequency of which is proportional to the vehicle speed.



Cruise control system development



Road speed sensor in position

Adaptive Cruise Control Conventional cruise control has now developed to a high degree of quality. It is however, not always very practical on many roads as the speed of the general traffic is constantly varying, and often very heavy. The driver has to take over from the cruise control system on many occasions to speed up or slow down. Adaptive cruise control can automatically adjust the vehicle speed to the current traffic situation. The system has three main aims:

Maintain a speed as set by the driver

Adapt this speed and maintain a safe distance from the vehicles in front

Provide a warning if there is a risk of collision.

System Operation The operation of an adaptive cruise system is similar to a conventional system. However, when a signal from the headway sensor detects an obstruction, the vehicle speed is decreased. If the optimum stopping distance cannot be achieved by just backing off the throttle, a warning is supplied to the driver. The more complex system can take control of the vehicle transmission and brakes. It is important to note that adaptive cruise control is designed to relieve the burden on the driver, not take full control of the vehicle!



Headway sensor



State why many vehicles have a twin horn system.



Look back over the previous section and write out a list of the key bullet points here:

MOBILE MULTIMEDIA

In Car Entertainment (ICE) Controls on most sets will include volume, treble, bass, balance and fade. Cassette tape options will include Dolby® filters to reduce hiss and other tape selections such as chrome or metal. A digital display of course, will provide a visual output of operating condition. This is also linked into the vehicle lighting to prevent glare at night. Track selection and programming for one or several compact discs is possible.

Anti-Theft Codes Many ICE systems are coded to deter theft. The code is activated if the main supply is disconnected and will not allow the set to work until the correct code has been re-entered. Some systems now include a plug in electronic 'key card', which makes the set worthless when removed.



Removable control panel

In Car Multimedia It would be almost unthinkable to not have radio cassette players in our vehicles. It does not seem too long ago however that these were optional extras! Looking back just a little further the in car record player must have been very interesting to operate - it was evidently quite successful in large American cars in the US, but left a bit to be desired in British vehicles on British roads! Shown here is a modern, factory fitted ICE system with a CD player.

Hi-Fi Quality In car entertainment (ICE) systems fitted to standard production cars, are now of good hi-fi quality. Facilities such as compact disc players and multiple compact disc changers together with automatic station search and re-tune are popular.

Speakers Good ICE systems include at least six speakers, two larger speakers in the rear to produce good low frequency reproduction, two front door speakers for mid-range and two front door tweeters for high frequency notes.

Speaker Construction

Speakers are a very important part of a sound system. No matter how good the receiver or CD player is, the sound quality will be reduced if inferior speakers are used. Equally, if the speakers are of a lower power output rating than the set, distortion will result at best and damage to the speakers at worst. Speakers fall into the following categories:

Tweeters - high frequency reproduction

Mid-range - middle range frequency reproduction (treble)

Woofers - low frequency reproduction (bass)

Sub-woofers - very low frequency reproduction.

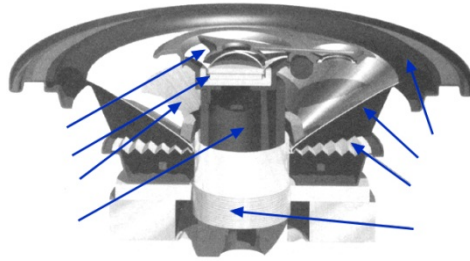

Construction of a speaker

Radio Data System (RDS) RDS has become standard on many radio sets. It is an extra inaudible digital signal, which is sent with FM broadcasts in a similar way to how text is sent with TV signals. RDS provides information so a receiver can appear to act intelligently. The possibilities available when RDS is used are as follows:



RDS display

The station name can be displayed in place of the frequency

Automatic tuning to the best available signal for the chosen radio station

Traffic information and news broadcasts can be identified and a setting made so that whatever you are listening to at the time can be interrupted.

Radio Reception □□□ There are two main types of radio signal transmitted: amplitude modulation (AM) and frequency modulation (FM). FM is generally a better source of high fidelity sound. This is because the quality of AM reception is limited by the narrow bandwidth of the signal. FM does however present problems with reception when mobile. As most vehicles use a rod aerial, which is omni-directional, it will receive signals from all directions. Because of this reflections from buildings, hills and other vehicles can reach the set all at the same time. This can distort the signal.

Digital Audio Broadcast (Dab) Digital audio broadcasting is designed to provide high quality digital radio broadcasting for reception by stationary and mobile receivers. It is being designed to operate at any frequency up to 3GHz. The system uses digital techniques to remove redundancy and perceptually irrelevant information from the audio source signal. All transmitted information is then spread in both the frequency and the time domains (multiplexed) so a high quality signal is obtained in the receiver, even under poor conditions.



Digital
broadcast
radio set

Auto PC A revolution in the use of information technology in vehicles is taking place. Advanced computing, communications and positioning developments are being introduced in even the most basic vehicles. Shown here is an 'Auto PC'/'Car Multimedia' system. Many leading computer companies, including Microsoft, IBM, and Intel have identified the vehicle as their next big marketplace. Plans have been announced for in-vehicle computers with a range of integrated functions. Microsoft's Auto PC, for example, uses a cut-down version of the standard Windows operating system.



In car
MP3Player

Functions The Auto PC will be able to run familiar desk-top programs whilst also offering the following:



Navigation display

Spoken turn-by-turn navigation

Digital map database of useful sites, such as filling stations and cinemas

Voice memo system

Vehicle diagnostics program

Vehicle security and tracking system

Emergency roadside assistance service

High-performance stereo system capable of playing CDs and receiving FM radio.

Mobile Communication Tying the computer in with the mobile communication system opens up even more possibilities. Cellular phone systems can provide an excellent means of tracking vehicles. Phone operators divide the country into separate cells and monitor phones as they move between them to ensure that each phone communicates through the best transmitter.

Mobile communication systems will have a profound impact on how vehicles are used. Development work is underway on the exchange of information between vehicles and the road infrastructure.

Cell Phones The first car telephones, which were so large, had the main unit fitted in the car boot! If the success of the cellular industry is any indication of how much we can make of the telephone, the future promises an even greater expansion. Cellular technology, which became useful in the 1980s, has continued to develop. In vehicle communication equipment for normal business and personal use, will be by the simple pocket sized mobile phone and there is no further market for the car telephone. Hands free conversions will still be important.



Mobile phones are everywhere!

ICE System

Circuit Shown

here is a circuit of a typical ICE system. An electric aerial is included and the connection to a multi compact disc unit via a data bus. The permanent supply is to keep memories alive.

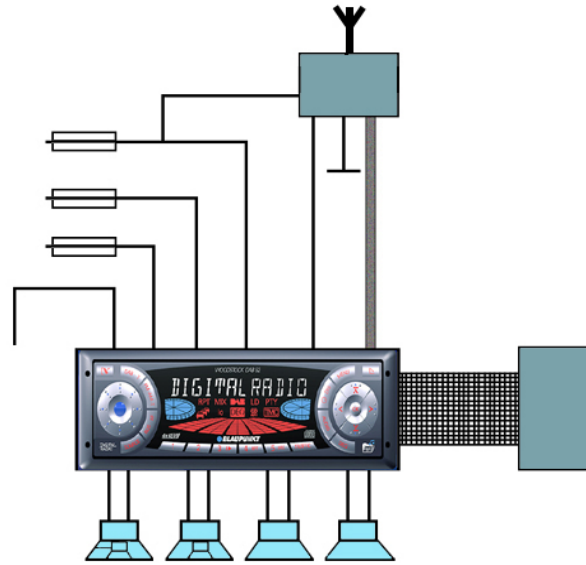

Circuit for an ICE system

 State the TWO main types of radio signal transmitted.

 List FIVE possible functions of an Auto PC

 Look back over the previous section and write out a list of the key bullet points here:

TOOLS AND EQUIPMENT

Introduction Components will usually be removed, inspected and repaired or replaced when a defect has been diagnosed. Other components are replaced, or stripped and cleaned, at scheduled mileage or time intervals. Refer to the Routine Maintenance section for details on these items.

General Toolkit General tools and equipment will be required for most tasks. As your career develops you will build a collection of tools and equipment. Look after your tools and they will look after you!

Electrical Tools There are only a few tools specifically associated with electrical systems. Some of the main ones are covered over the next few screens.

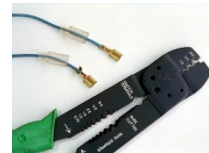

Crimping pliers and new terminals



Selection of wire strippers

Terminal Kit Many terminal kits are available. They usually consist of a selection of terminals and special pliers to crimp the terminals on to the wire.

Wire Strippers With practice you will be able to strip wire using side cutters. However, special tools are available to make the job easier. A number of different types are shown here.

Soldering Iron Most soldering irons are electrically heated. However, there are some very good gas powered types now available. The secret with a soldering iron is to use the right size for a specific job. One suitable for delicate ICs and circuit boards will not work on large alternator diodes. More damaging would be to use a large iron on a small circuit board!

Paper Clip Not found in Snap-on or other catalogues, but a very useful tool. It is not only ideal for bridging terminals as shown here; it can also be used for clipping paper together!

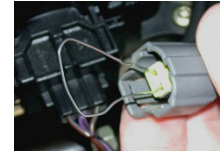

Paper clip in use

Summary Small tools such as electricians' screwdrivers or wire cutters are easy to misplace when working on a vehicle. The cost of these items if you lose them is clearly an issue, but so is the chance of damage to the vehicle. A 'spanner' in the works - can cause lots of trouble!



Look back over the previous section and write out a list of the key bullet points here:

ROUTINE MAINTENANCE

Scheduled Servicing Scheduled service requirements are often quite simple but none-the-less important. Systems should be checked for correct operation. Adjustments, repairs or replacements are then made if required. The servicing requirements for body electrical components are therefore still significant.

Non-Routine Work When carrying out routine maintenance, some non-routine work may be found. This should be reported to the driver or owner of the vehicle before expensive repairs are carried out.



Damaged wiper motor connections



Worksheet Service body electrical system.

This is a simple service operation but it is important that the tasks are carried out correctly. One of the first basic tasks is to check washer and wiper operation. Top up the washer fluid as required and don't forget to use a suitable additive.

Body Electrical Systems Inspect the wiper blades and recommend renewal as appropriate. Adjust and clean washer jets as required. A pin is often useful for this. Check the operation of the audible warning device - the horn should make a noise when the button is pushed! Carry out a quick check of all body systems. Check windows, door locks and sunroof - for smooth operation (electric or manual).



Wiper blades



Horn



Door locks



Mirrors

Supplementary Restraint System

Switch on the ignition and make sure all warning lights operate. Check in particular the supplementary restraint system (SRS) light, and that it goes out when the engine starts. Inspect all air bag positions for security.

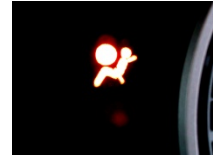

SRS warning light



Drivers airbag position



Passenger airbag position



Side airbag position

ICE System Check the ICE system aerial for security. Test the ICE system by listening to each speaker in turn. Make sure you reset the unit to the customer's preferences. A great looking set from Pioneer is shown here. The system has an Organic Electro-luminescent Display (OED).



Worksheet Service/Check seatbelt



Seatbelt lock mechanism

operation.

Caution: Some seatbelts incorporate tensioners that operate in the event of a collision. Do not attempt to dismantle these systems without reference to the manufacturer's data. Check for twisted webbing due to incorrect alignment. Adjust as required.

Seat Belts Fully extend each belt in turn and inspect the webbing. Look for cuts, damage, broken threads, colour fading and bowed webbing. If any damage is noted the belt should be renewed. Follow the manufacturer's procedures for this process. If the belt will not extend, check for contamination and twisting.



Checking the belt condition

Safety Belt Operation Insert the tongue of each belt into its buckle. Pull hard to make sure it locks in place. Follow manufacturers' procedures to renew if in any doubt. Push the button to make sure the belt releases from the buckle easily. Pull each belt in turn fully out and make sure it retracts. It is acceptable to guide the belt home and prevent twisting. However, the spring should pull the belt into its fully retracted position.

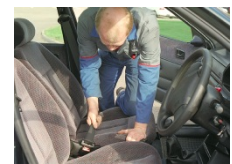

Seatbelt buckle operation

Friction and Inertia Belt Locks Pull sharply on each belt in turn to check that it locks up. Drive the vehicle in an area away from other traffic, and brake sharply from about 10 mph /16 kph. The driver's belt should lock and hold you in position. Use an assistant to check the other belts if necessary.

Summary The previous tasks will normally be carried out as part of a general service. If extra work such as damage or incorrect operation is noticed, this should be reported to the customer.



Look back over the previous section and write out a list of the key bullet points here:

BODY ELECTRICAL - CUSTOMER CARE

Regular Checks Regular servicing is vital for a customer's safety. Carry out checks at all services and report your findings to the customer. Advise customers if anything will need attention before the next scheduled service interval.

Vehicle Condition Respect your customer's vehicle and take precautions to keep it clean. Repairing or checking some systems, is likely to involve you working under the vehicle, and then sitting in the driver's seat. Use seat covers and ensure the steering wheel is clean when you have finished.

Keep Customers Informed Some customers like to know details of what work has been done to their vehicle - and they have

every right to know! This wiper motor, for example, had been changed, but was kept for the customer to see.



Wiper motor

System Operation Some of the body electrical systems can appear complex, to the customer, at first view. However, they will appreciate you taking the time to explain the operation of these systems. For example, although the handbook contains instructions, showing your customer how the CD and radio remote control operates will be helpful.

Quality Replacement Components It is often tempting to increase the profit on a job by using 'pattern' parts. These are copies of the original components. Some of these components, produced by well-known companies (Bosch for example) are excellent quality and are used as original equipment by many manufacturers. However, some pattern parts are cheap, and you get what you pay for! One of the most irritating things for a customer is to have to return the vehicle for the same job to be repeated - and it wastes your time. Use good quality parts at all times.



Bosch wiper components

Safety Advice It is not possible to be specific about safety advice here as issues vary between manufacturers. Their instructions relating to safety should always be followed. One common issue however, is the positioning of a child or baby seat. Cars fitted with airbags, which is almost all modern vehicles, come with specific recommendations about where the seat should be fitted. Pass on this advice to your customer at all times.

Summary A customer, who is kept informed and treated with respect, will return and keep you in a job! Explain things to a customer when asked - it will be appreciated.

MONITORING AND INSTRUMENTATION

SENSORS

Introduction Sensors are used on vehicles for many purposes. For example, the coolant temperature thermistor is used to provide data to the engine management system as well as for the driver. The information to the driver is provided by a display or gauge.

Sensors The following screens list some of the things on a car that are sensed or measured, together with typical sensors. The sensors convert what is being measured into an electrical signal. This signal can then be used to operate a display, such as a gauge or warning light, on the instrument panel.

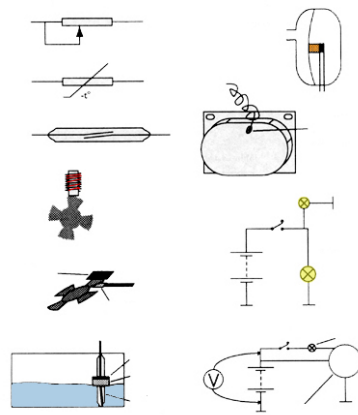

Sensors used for instrumentation

Fuel Level Fuel level is measured by using a variable resistor that is moved by a float. The position of the float is determined by how much fuel is in the tank. The resistance value is varied by a contact sliding over a resistor.



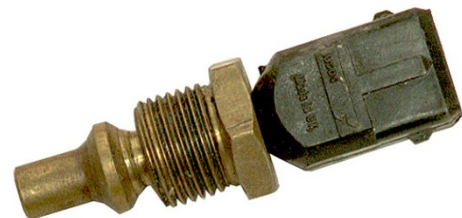

Tank sender ...And empty unit full...

Temperature The most common temperature measurement is that of the engine coolant. However, outside air, cabin, air intake and many other temperatures, are measured. A thermistor is used for most applications. A thermistor is a special material that changes its resistance with temperature. Most types are described as negative temperature coefficient (NTC). This means that as temperature increases, their resistance decreases.



Temperature sensor

Bulb Failure  A reed switch consists of two small strips of steel. When these become magnetised, they join and make a circuit. Bulb failure circuits often use a reed relay to monitor the circuit. In the circuit shown, the contacts of the reed switch will only close when electricity is flowing to the bulb being monitored.

Road Speed  Road speed is often sensed using an inductive pulse generator. This sensor produces an AC output with a frequency, which is proportional to speed. It is like a small generator that is driven by a gear on the gearbox output shaft. This type of sensor is also used to sense engine speed from the flywheel or crankshaft.

Engine Speed  Engine speed can be sensed in a number of ways. The Hall effect sensor however, is a very popular choice, as it is accurate and produces a square wave output with a frequency proportional to engine speed. The Hall IC produces a voltage when it is in a magnetic field. The rotating plate shown here alternately prevents and allows the magnetism to reach the IC.

Fluid Level  Fluid levels, such as washer fluid or radiator coolant, are often measured or sensed using a float and reed switch assembly. The float has a magnet attached that causes the contacts to join when it is in close proximity. The float moves up or down depending on the fluid level.

Oil Pressure □□□ Oil pressure may be measured and displayed on a gauge or, as is most common, by using a simple warning light. For this purpose, a diaphragm switch is used. As oil pressure increases, it is made to act on a diaphragm. Once it overcomes spring pressure, the contacts are operated. The contacts can be designed to open or close as pressure reaches a set level.

Brake Pad Wear

Brake pad wear is sensed by using a simple embedded contact wire. When the friction material wears down the embedded contact makes contact with the disc to complete a circuit.

Some systems use a loop of wire that is broken when the pad wears out.

✎ Brake pads with sensor wires

Lights in Operation □□□ Lights in operation can be monitored by a bulb and simple circuit. However, note that this circuit will only indicate that the switch is on, it will not confirm that the circuit is working. A good example of this is the main beam warning light.

Battery Charge Rate □□□ Battery charge rate can be sensed by a simple bulb circuit. The charge warning light is caused to go out when the alternator produces an output on one side of the bulb, which is the same as that supplied by the battery to the other side. If an equal voltage is supplied to both sides, the voltage across the warning light will be zero, and hence it will not be lit!

Summary □□□ A wide range of sensors is used to operate instrument displays. Sensors convert what is being measured into an electrical signal. This may be by a simple on/off operation, a changing voltage output or a change in resistance.



State FIVE temperatures that are measured regularly.



Look back over the previous section and write out a list of the key bullet points here:

GAUGES

Introduction By definition, an instrumentation system can be said to convert a 'variable' into a readable or usable display. For example, a fuel level instrument system will display a representation of the fuel in the tank using an analogue gauge.



Instrument panel

Instrumentation Instrumentation is not always associated with a gauge or a read-out type display. In many cases, a system can be used just to operate a warning light. However, it must still work to certain standards. For example, if a low outside temperature warning light did not illuminate at the correct time, a dangerous situation could develop.

Thermal Type Gauges Thermal gauges, which are ideal for fuel and engine temperature indication, have been in use for many years. This will continue because of their simple design and inherent 'thermal' damping. The gauge works by utilising the heating effect of electricity and the widely adopted benefit of the bimetal strip.



Fuel gauge display

Bimetal Strip □□□ As a current flows through a simple heating coil wound on a bimetal strip, heat causes the strip to bend. The bimetal strip is connected to a pointer on a suitable scale. The amount of bend is proportional to the heat, which in turn is proportional to the current flowing. Providing the sensor can vary its resistance in proportion to the fuel level or temperature, the gauge will indicate a suitable representation.

Damping The inherent damping is due to the slow thermal effect on the bimetal strip. This causes the needle to move very slowly to its final position. This is a particular advantage for displaying fuel level, as the variable resistor in the tank will move, as the fuel moves, due to vehicle movement. If the gauge reacted quickly, it would be constantly moving. The movement of the fuel however, is in effect averaged out and an accurate display can be obtained.

Variable

Resistance

Thermal type

gauges are

used with a

variable

resistor. This

is either a

float in the

fuel tank or a

thermistor in

the engine

water jacket.

The sender

resistance is

usually at a

maximum when

the tank is

empty or the

engine is cold.

 Fuel and temperature gauge circuit

Voltage Stabiliser □□□ A constant voltage supply is required to prevent changes in the system voltage, affecting the reading. This is because if system voltage increased, the current flowing would increase, and the gauges would read higher. Most voltage stabilisers are simple zener diode circuits as shown here.

Moving Iron Gauges The moving iron gauge was in use earlier than the thermal type but is again gaining popularity on some cars. Two small electro magnets are used, which act upon a small soft iron armature. This armature is then connected to a pointer. The armature will position itself in between the cores of the electromagnets depending on the magnetic strength of each. The ratio of magnetism in each core is changed as the variable resistance sender changes.



Gauge on an older vehicle

Gauge Movement □□□ This type of gauge reacts very quickly and is prone to swing about with movement of the vehicle. Some form of external damping can be used to improve on this problem. Resistor R_1 is used to balance out the resistance of the tank sender. A good way to visualise the operation of the circuit is to note that when the tank is half full, the resistance of the sender will be the same as the resistance of R_1 . This makes the circuit balanced and the gauge will read half full. The sender resistance is at a maximum when the tank is full.

Air Cored Gauges Air cored gauges work on the same principle as a compass needle lining up with a magnetic field. The needle of the display is attached to a very small permanent magnet. Three or more coils of wire are used and each produces a magnetic field. The magnet, and therefore the needle, will line up with the resultant of the three fields. The current therefore, flowing through each coil, is the key to moving the needle position.

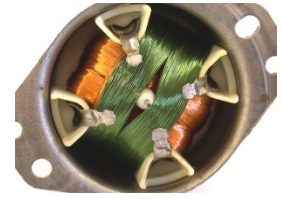

Gauge details

Gauge Operation □□□ The principle of the air-cored gauge, together with the circuit for use as a temperature indicator. The resistor on the left is used to limit maximum current and the calibration resistor is used for calibration! The thermistor is the temperature sender. As the thermistor resistance increases, the current in all three coils will change. Current through C, which is one coil but wound in two parts, will be increased but the current in coils A and B will decrease. As the resistance decreases the opposite will occur thus moving the needle from cold to hot.

Air-Cored Gauge Advantages □□□ The air-cored gauge has a number of advantages. It has almost instant response and as the needle is held in a magnetic field, it will not move as the vehicle changes position. The gauge can be arranged to continue to register the last position even when switched off. If a small 'pull off' magnet is used, it will return to its zero position. A change in system voltage would affect the current flowing in all three coils. Variations are therefore cancelled out so a voltage stabiliser is not needed. The operation is similar to the moving iron gauge.

Other Gauges A variation of any of the above types of gauge can be used to display other required outputs such as voltage or oil pressure. Gauges to display road or engine speed, however, need to react very quickly to changes. Many systems now use a stepper motor or other type of electrical gauge for this purpose.

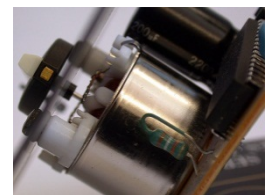

Stepper motor tachometer

Cable Speedometer Some cars still use conventional cable driven speedometers. The head units usually work by either friction or magnetism. The frictional or magnetic 'drag' increases as speed increases and this is used to move a needle. The flexible cable is driven from the gearbox output. It has square ends to transfer the rotation.



Speedometer cable and head

Electronic Speedometer  Shown here is a block diagram of a speedometer, which uses an ammeter as the gauge. This system uses a quenched oscillator sensor. This sensor produces a constant signal, even at very low speed. The frequency of the signal is proportional to road speed. The sensor is driven from the gearbox or a final drive output. The gauge will read an average of the pulses from the sensor. This average value is dependent on the frequency of the input signal, which in turn is dependent on vehicle speed. The odometer is driven by a stepper motor, which is driven by the output of a divider and an amplifier.

Revcounter or Tachometer The system for driving most revcounters is similar to the electronic speedometer system. Pulses from the ignition primary circuit are often used to drive the gauge. The revcounter needle response is damped to give a steady reading.



Tachometer display

Summary A number of different gauges are used for instrumentation displays. The most common for fuel and temperature display are thermal, moving iron and air-cored. Speedometers and tachometers use stepper motors, electrical gauges or mechanical systems.



Explain the basic operation of a thermal gauge.



Look back over the previous section and write out a list of the key bullet points here:

TOOLS AND EQUIPMENT

Introduction Components will usually be removed, inspected and repaired or replaced when a defect has been diagnosed. Other components are replaced, or stripped and cleaned, at scheduled mileage or time intervals. Refer to the Routine Maintenance section for details on these items.

General Toolkit General tools and equipment will be required for most tasks. As your career develops you will build a collection of tools and equipment. Look after your tools and they will look after you!

Torque Wrench A good torque wrench is an essential piece of equipment. Many types are available but all work on a similar principle. Most are set by adjusting a screwed cylinder, which forms part of the handle. An important point to remember is that, as with any measuring tool, regular calibration is essential to ensure it remains accurate.

Air Guns The whole point of power tools is that they do the work so you don't have to! Most air guns have an aluminium housing. This material is lightweight but gives long life. Air guns produce a 'hammer' action. Because of this, impact sockets should be used. Normal sockets can shatter under this load. It is important to remember that air tools need lubricating from time to time.

Transmission Jack If a complete gearbox has to be removed, it is likely to be heavy! A transmission jack has attachments that allow you to support the gearbox and lower it safely. The equipment is hydraulically operated just like an ordinary jack. Often, the height can be set by using a foot pedal, which leaves both hands free for positioning the unit.



This jack will support a gearbox

Bearing Puller Removing some bearings is difficult without a proper puller. For internal bearings, the tool has small legs and feet that hook under the bearing. A threaded section is tightened to pull out the bearing. External pullers hook over the outside of the bearing and a screwed thread is tightened against the shaft.



Internal bearing puller



External bearing puller

Air Ratchet These tools are very useful for removing or fitting nuts and bolts. However, it is possible to over tighten if care is not taken. Air tools can be very powerful and will trap your hands! Take adequate precautions at all times.



These tools are very useful



Look back over the previous section and write out a list of the key bullet points here:

ROUTINE MAINTENANCE

Scheduled Servicing Scheduled service requirements are often quite simple but none-the-less important. Systems should be checked for correct operation. Adjustments, repairs or replacements are then made if required.

Non-Routine Work When carrying out routine maintenance, some non-routine work may be found. This should be reported to the driver or owner of the vehicle before repairs are carried out.



Worksheet Checking operation of the

main instruments and warning lights.

This is a simple but important task. Instruments and warning lights when operating correctly can prevent breakdowns and damage. The first step is to switch the ignition on. However, do not start the engine at this stage.

Ignition On Tests With the ignition on, check that the rev-counter and speedometer both read zero. However, in some cases they will read below the zero when at rest. Make sure that the oil pressure and charge warning lights are on. The fuel gauge should read appropriate to the level of fuel in the tank. The temperature gauge should read appropriate to the engine temperature. It is best to start these checks with the engine cold if possible.



Instruments and warning lights



Gauges

Engine Running Tests Check for neutral or park, and start the engine. The oil light and charge light should go out as the engine revs. They should then stay out at idle speed. Check that the rev-counter reads correctly. If necessary, this can be done by comparing it with a test meter reading. The fuel gauge reading should remain constant and the temperature gauge should rise to 'normal' level.

Road Test A road test is the best way to check the speedometer operation. However, this will usually be part of a service and many other aspects should be considered. If you are not qualified to drive the particular vehicle, then go along as a passenger. You can then instruct the driver on what to check.



Worksheet Check operation of vehicle



Trip computer

map and trip computer.

Many vehicles are now fitted with a map, which is like a plan view of the car showing lights and doors. Trip computers are useful for keeping a check on fuel consumption and journey times. Most have a mode switch to change between UK, US and metric units. Refer to the vehicle handbook as necessary, for specific details.

Static Tests To check the map operation the ignition may need to be on. First, switch all of the lights on in turn and check the operation of each map segment. Next, open all the doors in turn and again check that their segments illuminate. Switch ignition off and then back on. Note self-test for ice warning if it is fitted. A large snowflake should flash!

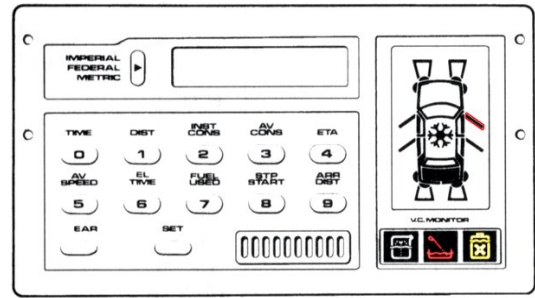

Vehicle map and trip computer

Running Tests Check all the basic functions of the trip computer. The main ones are: time, date and stop watch. Set a journey distance into the unit. Road test the car and note other functions such as average speed, estimated time of arrival, fuel consumption and elapsed time. Reset all when the test is complete. Make sure that the correct units (miles/kilometres) are set.

Summary Safety of all road users and pedestrians is essential. Reliable operation of the vehicle is also important. The condition of all systems is therefore vital. Carry out a check at all service intervals.



Look back over the previous section and write out a list of the key bullet points here:

INSTRUMENTATION - CUSTOMER CARE

Regular Checks Regular servicing is vital for a customer's safety. Carry out checks at all services and report your findings to the customer. Advise customers if anything will need attention before the next scheduled service interval.

Vehicle Condition Respect your customer's vehicle and take precautions to keep it clean. Repairing or checking some systems, is likely to involve you working under the vehicle, and then sitting in the driver's seat. Use seat covers and ensure the steering wheel is clean when you have finished.

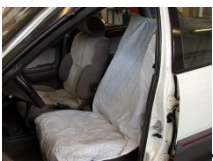

Seat covers in use

Reading the Instruments Instruments can be confusing for some customers. Take the time to explain what your customer should look for. Most will be familiar with the operation of the fuel gauge. However, the temperature gauge may give them concern. Explain that a small fluctuation in readings is normal

but they should report symptoms such as high readings and long warm up times. This last point for example, may mean the thermostat is stuck open. An early warning of this will save your customer trouble in the future.

Warning Lights Warning lights are something that many of your customers will probably not notice, until one comes on unexpectedly! You may need to explain which are serious and which are not. For example, the oil pressure or charge warning lights are more serious than say low washer fluid. On most cars, red warning lights, as you would expect, are the most important.

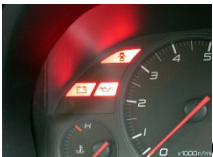

Charge and oil warning lights

Trip Computers Trip computers are useful, but can be confusing for some users. If necessary explain to your customer how to set and use the different functions. A function that is often used, is 'average fuel consumption'. This helps the customer keep an eye on how well you did the last tune up!

Summary A customer who is kept informed and treated with respect will return and keep you in a job! Explain things to a customer when asked - it will be appreciated.

HEATING, VENTILATION AND AIR CONDITIONING

VENTILATION SYSTEMS

Introduction Fresh air helps to keep the driver of a vehicle alert. Most cars now allow a wide range of settings for ventilation.

Plenum Chamber □□□ To allow fresh air from outside the vehicle to be circulated inside the cabin a pressure difference must be created. This is achieved by using a plenum chamber. A plenum chamber by definition holds a gas, in this case air, at a pressure higher than the ambient pressure.

Airflow The plenum chamber on a vehicle is usually situated just below the windscreen, behind the bonnet. When the vehicle is moving the airflow over the vehicle will cause a higher pressure in this area. Suitable flaps and drains are utilised to prevent water entering the car through this opening.

Recirculated Air Many vehicles allow a choice between fresh or recirculated air. The main reason for this is to decrease the time taken to heat or cool the car interior. The other reason is that for example, in heavy congested traffic, the outside air may not be very clean.



Ventilation controls

Air Distribution By means of distribution trunking, control flaps and suitable nozzles, the air can be directed as required. This system is enhanced with the addition of a variable speed blower motor.



Control flaps

Air Outlets When extra air is forced into a vehicle cabin, the interior pressure would increase if no outlets were available. Most passenger cars have the outlet grills on each side of the vehicle above the rear quarter panel.



Outlet vents

Blower Motors The motors used to increase airflow are simple permanent magnet two brush motors. The blower fan is often the centrifugal type and in many cases, the blades are positioned asymmetrically to reduce resonant noise.

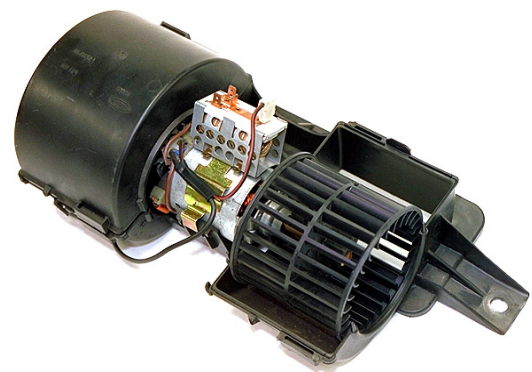

Typical motor and fan arrangement

Speed Control Varying the voltage supplied, controls the motor speed. This is achieved by using dropping resistors. The speed can be made infinitely variable, by the use of a variable resistor. In most cases, the motor is controlled to three or four set speeds.



Checking voltage at the resistor pack

Three-Speed Control System  Shown here is a circuit diagram typical of a three-speed control system. The resistors are usually wire wound and are placed in the air stream to prevent overheating. These resistors will have low values in the region of 1Ω or less.

Summary Ventilation, as well as the obvious need for fresh air, contributes to road safety by helping to keep the driver alert. Most systems are a simple arrangement of flaps, trunking and vents.



State the definition of a plenum chamber.



Look back over the previous section and write out a list of the key bullet points here:

Introduction Any heating and ventilation system has a simple set of requirements. These are summarised as follows:



Heater controls

- An adjustable temperature in the vehicle cabin
- Heat must be available as soon as possible
- Heat can be distributed to various parts of the vehicle
- Fresh air ventilate possible but with minimum noise
- All windows can be demisted
- Easy control operation.

Engine Heat □□ Heat from the engine can be used to increase the temperature of the car interior. This is achieved by use of a heat exchanger, often called the heater matrix. Due to action of the thermostat in the engine cooling system, the water temperature remains reasonably constant. The air being passed over the heater matrix is therefore heated to a set level.

Heater Matrix The heater matrix is like a small radiator. It consists of many tubes surrounded by fins to increase the surface area. Copper was used at one time but most modern heater matrixes are aluminium with plastic header tanks.



Heater radiator

Hot Air A source of hot air is now available for heating the vehicle interior. However, some form of control is required over how much heat is required.



Heater outlet

Heat Control □□□ The control method used on most modern vehicles is blending. This is a control flap, which determines how much of the air being passed into the vehicle is directed over the heater matrix. Some systems use a valve to control the hot coolant flowing to the heater matrix.

Direction Control By a suitable arrangement of flaps, it is possible to direct air of the chosen temperature to selected areas of the vehicle interior. Basic systems allow the warm air to be adjusted between the inside of the windscreen and the driver and passenger foot wells. Fresh cool air outlets with directional nozzles are also fitted.

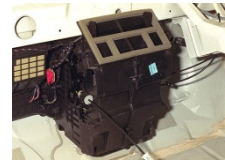

Heater box and flaps

Heater Blower Motor A blower motor in the air intake duct boosts airflow through the heater. The motor is usually fitted with a series of resistors in order to provide a range of speeds. The motor switch routes the electric current through the appropriate resistor for the speed selected on the switch.



Double fan



Single fan



Wide fan



Blower box

Demisting Outlets are positioned for directing air onto the inside of the screen. Some cars also have outlets to direct air onto the side windows. All the output air from the heater can be directed in this way if required.



Demister outlets

Air Cooling □□□ Air-cooled systems have the air stream passing directly over the engine cylinders and cylinder heads to remove the heat at the source. Fins are cast into the cylinders and cylinder heads to increase the surface area of the components and therefore ensure that sufficient heat is lost.

Heat Exchanger □□□ Because of how air-cooling works it is difficult to collect heat for use in the vehicle. Some systems use a heat exchanger as part of the exhaust system. The danger of this is that if the exhaust corrodes, gases can be taken into the vehicle. Flaps are used in the same way as for water-cooled systems to control temperature and direction. However, controlling the heat output from these systems is a problem.

Summary Heating is an important passenger comfort system. The demisting function is an indispensable feature. Most cars use heat from the cooling system to heat the interior. A heater matrix is used for this purpose. A blower motor together with distribution and blending flaps provides the control.



Describe the construction of a heater matrix/radiator



State TWO air outlets used for demisting/defogging



Look back over the previous section and write out a list of the key bullet points here:

TOOLS AND EQUIPMENT

Introduction Components will usually be removed, inspected and repaired or replaced when a defect has been diagnosed. Other components are replaced, or stripped and cleaned, at scheduled mileage or time intervals. Refer to the Routine Maintenance section for details on these items.

Recommended Procedures The descriptions provided in this section deal with the components for individual replacement, rather than as a part of other work. Always refer to a workshop manual before starting work. You will also need to look for the recommended procedure, special tools, materials, tightening sequences and torque settings. Some general and specific tools and pieces of equipment are described on the following screens.

General Toolkit General tools and equipment will be required for most tasks. As your career develops you will build a collection of tools and equipment. Look after your tools and they will look after you!



Snap-on tools

Torque Wrench A good torque wrench is an essential piece of equipment. Many types are available but all work on a similar principle. Most are set by adjusting a screwed cylinder, which forms part of the handle. An important point to remember is that, as with any measuring tool, regular calibration is essential to ensure it remains accurate.



A torque wrench is a useful tool

Air Guns □□□ The whole point of power tools is that they do the work so you don't have to! Most air guns have an aluminium housing. This material is lightweight but gives long life. Air guns produce a 'hammer' action. Because of this, impact sockets should be used. Normal sockets can shatter under this load. It is important to remember that air tools need lubricating from time to time.

Jacks and Stands Most jacks are simple hydraulic devices. Remember to make sure the safe working load (SWL) is not exceeded. Ensure that any faults with equipment such as this are reported immediately. Axle stands must always be placed under the vehicle supporting the weight - before work is carried out.



Always use stand after jacking a vehicle

Ramps and Hoists Many ramps are available ranging from large four-post wheel-free types to smaller single-post lifts. These large items should be inspected regularly to ensure they are safe.



Four post lift in use

Transmission Jack If a complete gearbox has to be removed, it is likely to be heavy! A transmission jack has attachments that allow you to support the gearbox and lower it safely. The equipment is hydraulically operated just like an ordinary jack. Often, the height can be set by using a foot pedal, which leaves both hands free for positioning the unit.



This jack will support a gearbox

Bearing Puller Removing some bearings is difficult without a proper puller. For internal bearings, the tool has small legs and feet that hook under the bearing. A threaded section is tightened to pull out the bearing. External pullers hook over the outside of the bearing and a screwed thread is tightened against the shaft.



Internal and external bearing puller

Air Ratchet These tools are very useful for removing or fitting nuts and bolts. However, it is possible to over tighten if care is not taken. Air tools can be very powerful and will trap your hands! Take adequate precautions at all times.



These tools are very useful

AC Servicing Unit Most modern servicing units can be used to drain, recycle, evacuate and refill air conditioning systems. Some older types would only carry out individual procedures. Note that different servicing units are required for R12 and R134a refrigerants and their oils must not be mixed with one another. If work is to be carried out on an air conditioning system, a servicing unit is essential. Refrigerant must never be released into the atmosphere.



Servicing equipment



Look back over the previous section and write out a list of the key bullet points here:

ROUTINE MAINTENANCE

Scheduled Servicing Scheduled service requirements are often quite simple but none-the-less important. Systems should be checked for correct operation. Adjustments, repairs or replacements are then made if required.



Worksheet Check operation of heating

and ventilation system.

This is a straightforward task but none-the-less important. Correct operation of the heating and ventilation system is not only important for occupant comfort, it is also a safety feature. Particularly in cold weather, screen demisting is critical.

System Operation To test the system operation, first start the engine and run until it is warm. Use extraction if working indoors. Next, check that the booster fan runs at all speeds. Switch off the air conditioning (AC) if fitted. Set the temperature control to cold and the fan speed to a medium setting. Run through all direction settings and check that COOL air is supplied.



Heater controls



Engine is up to temperature when the top hose is hot

Temperature Control To check the heater operation, set the temperature control to hot and the fan speed to a medium setting. Run through all direction settings and check that HOT air is supplied. Next, check that a range of temperatures can be selected and that external or recirculated air can be used. Make sure all ventilation grills open and allow directional control.



Air outlets

Screen Heaters All modern cars have heated rear screens. Front screen heating, which is more difficult because of the potential obstruction, is used on some vehicles. Check heated screen operation by switching on, and breathing on the screen, inside, to make sure the condensation clears almost instantly. Many screen heaters are fitted with a timer that switches off after about ten minutes. Some require the engine to be running before they will operate. This is because they draw a relatively high current from the battery.

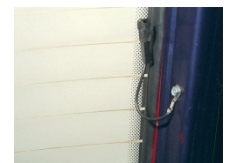
Rear screen
heater
elements



Worksheet Check operation of air

conditioning (AC) system.

This is a straightforward task but none-the-less important. Correct operation of the air conditioning system is not only important for occupant comfort, it is also a safety feature. In cold weather, screen demisting is critical. In very hot weather, air conditioning improves driver concentration, which also aids safety.

Air Conditioning Start the engine and run until it is warm. Remember to use extraction if working indoors. Check that the booster fan runs at all speeds. Set the temperature control to cold, switch the air conditioning on and run the fan at maximum speed. Set the air to recirculated and check that *COLD* air is supplied. Some manufacturers specify a temperature at the ventilation outlets of between 2 and 6 °C.



Air
conditioning
controls

Hot Air Supply Leave the air conditioning switched on and set the temperature control to hot. Reset the fan speed to a medium setting. Run through all the direction settings and check that HOT air is supplied. Check that a range of temperatures can be selected even with the air conditioning switched on. Make sure all ventilation grills open and allow directional control. Remember, as well as the obvious cooling effect of air conditioning, the system removes moisture, making the environment more pleasant.



Checking for hot air

Heated Screens AC systems improve screen demisting because they remove moisture from the air by condensing it on the evaporator. However, heated screen operation should still be checked as described previously.

Pollen Filters Pollen filters are fitted to some vehicles. They remove small particles from incoming air. They should be replaced at regular intervals. Also, check and remove any contamination from the air intake area.



Filter replacement

Action to Cure Smells! Air conditioning systems can occasionally smell musty and damp. This is due to particles of dirt in the evaporator housing sticking to the condensation. The warm moist environment is conducive to the growth of microorganisms and fungi. This is more likely to be a problem in warm climates. Manufacturers recommend specific procedures for their vehicles, but often an aerosol of special disinfectant will do the job. Follow the instructions on the product carefully.



Evaporator
disinfectant

Summary Safety of all road users and pedestrians is essential. Reliable operation of the vehicle is also important. The condition of all systems is therefore vital. Carry out a check at all service intervals.



Look back over the previous section and write out a list of the key bullet points here:

Regular Checks Regular servicing is vital for a customer's safety. Carry out checks at all services and report your findings to the customer. Advise customers if anything will need attention before the next scheduled service interval.

Vehicle Condition Respect your customer's vehicle and take precautions to keep it clean. Repairing or checking some systems, is likely to involve you working under the vehicle, and then sitting in the driver's seat. Use seat covers and ensure the steering wheel is clean when you have finished.

Communication Some AC systems, at first view, may appear complex. Help your customers by showing them how the different functions are operated. Some customers may think they have a fault with their system, when in fact it is operator error! Some systems for example, run the demist option automatically for a few seconds after the engine first starts. The controls do not make any difference during this time and thus it may appear that there is a fault.

Recommendations During the winter period, it is possible that the AC system will not be used. Recommend to your customers that it is beneficial to run the system at least once a month. This ensures that the compressor stays lubricated and the refrigerant is distributed throughout the system. Many systems cause the AC to be switched on automatically when the front screen 'demist' option is selected.

Summary A customer who is kept informed and treated with respect will return and keep you in a job! Explain things to a customer when asked - it will be appreciated.

CHASSIS SYSTEMS

SUSPENSION

REASONS FOR SUSPENSION

Introduction The suspension system is the link between the vehicle body and the wheels. Its purpose is to:

Locate the wheels whilst allowing them to move up and down, and steer

Maintain the wheels in contact with the road and minimise road noise

Distribute the weight of the vehicle to the wheels

Reduce vehicle weight as much as possible - in particular the unsprung mass

Resist the effects of steering, braking and acceleration

Work in conjunction with the tyres and seat springs to give acceptable ride comfort.



Suspension plays a key role

Compromise The previous list is difficult to achieve completely, so some sort of compromise has to be reached. Because of this, many different methods have been tried, and many are still in use. Keep these requirements in mind, and it will help you to understand why some systems are constructed in different ways.

Sprung and Unsprung Mass  Unsprung mass is usually the mass of the suspension component, the wheels and the springs. However only 50% of the spring mass and the moving suspension arms are included. This is because they form part of the link between the sprung and unsprung masses. It is beneficial to have the unsprung mass as small as possible in comparison with the sprung mass (main vehicle mass). This is so that when the vehicle hits a bump the movement of the suspension will have only a small effect on the main part of the vehicle. The overall result is therefore improved ride comfort.

Further In Suspension A vehicle needs a suspension system to cushion and damp out road shocks. This provides comfort to the passengers and prevents damage to the load and vehicle components. A spring between the wheel and the vehicle body allows the wheel to follow the road surface. The tyre plays an important role in absorbing small road shocks. It is often described as the primary form of suspension. The vehicle body is supported by springs located between the body and the wheel axles. Together with the damper, these components are referred to as the suspension system.



Suspension system

Effect of Suspension  As a wheel hits a bump in the road, it is moved upwards with quite some force. An unsprung wheel is affected only by gravity, which will try to return the wheel to the road surface. However, most of the energy will be transferred to the body. When a spring is used between the wheel and the vehicle body, most of the energy in the bouncing wheel is stored in the spring and not passed to the vehicle body. The vehicle body will only move upwards through a very small distance compared to the movement of the wheel.

Springs These parts of the suspension system take up the movement or shock from the road. The energy of the movement is stored in the spring. The actual spring itself can be in many different forms, ranging from a steel coil to a pressurised chamber of nitrogen. Soft springs provide the best comfort, but stiff springs can be better for high performance. Vehicle springs and suspension therefore are made to provide a compromise between good handling and comfort.



Coil spring



Leaf spring

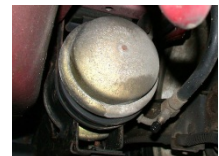

Gas spring

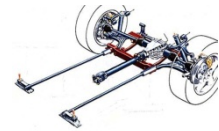

Torsion bar
spring

 Sketch some examples of springs here

Dampers or Shock Absorbers The energy stored in the spring after a bump, has to be got rid of or else the spring would oscillate (bounce up and down). The damper damps down these oscillations by converting the energy from the spring into heat. If working correctly the spring should stop moving after just one bounce and rebound. Shock absorber is a term, which is often used, to describe a damper.



Telescopic damper

Strut The combination of a coil spring with a damper inside it, between the wheel stub axle and the inner wing, is often referred to as a strut. This is a very popular type of suspension.

Wishbone A

wishbone is a triangular shaped component with two corners hinged in a straight line on the vehicle body. The third corner is hinged to the moving part of the suspension.



McPherson strut



Front suspension wishbone

Bump Stop When a vehicle hits a particularly large bump, or if it is carrying a heavy load, the suspension system may bottom out (reach the end of its travel). The bump stop, usually made of rubber, prevents metal-to-metal contact, which would cause damage.



Rubber stop

Link A link is a very general term, which is used to describe a bar or other similar component that holds or controls the position of another component. Other terms may be used such as tie-bar or tie-rod.

Beam Axle This is a solid axle from one wheel to the other. It is not now used on the majority of light vehicles. However, as it makes a very strong construction, it is still common on heavy vehicles.



Heavy vehicle axle

Gas/Fluid Suspension The most common types of spring are made from steel. However, some vehicles use pressurised gas as the spring, (think of a balloon or a football). On some vehicles, a connection between wheels is made using fluid running through pipes from one suspension unit to another.

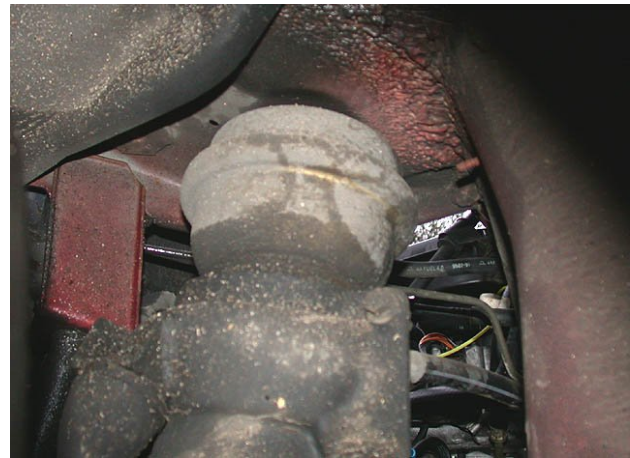

Gas suspension unit

Independent Suspension  Independent front and rear suspension (IFS/IRS) was developed to meet the demand for improved ride quality and handling. The main advantages of independent suspension are as follows:

- When one wheel is lifted or drops, it does not affect the opposite wheel
- The unsprung mass is lower; therefore, the road wheel stays in better contact with the road
- Problems with changing steering geometry are reduced
- More space for the engine at the front
- Softer springing with larger wheel movement is possible.

Anti-Roll Bar The main purpose of an anti-roll bar is to reduce body roll on corners. The anti-roll bar can be thought of as a torsion bar. The centre is pivoted on the body and each end bends to make connection with the suspension/wheel assembly. When the suspension is compressed on both sides, the anti-roll bar has no effect because it pivots on its mountings. As the suspension is compressed on just one side, a twisting force is exerted on the anti-roll bar. Part of this load is transmitted to the opposite wheel, pulling it upwards. This reduces the amount of body roll on corners.

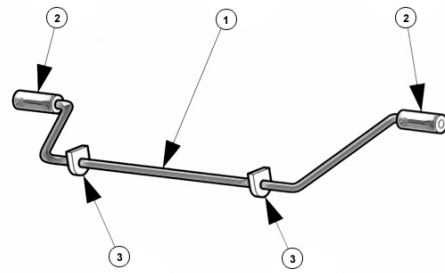

Shape of an anti-roll bar

Panhard Rod The

Panhard rod was named after a French engineer.

Its purpose is to link a rear axle to the body. The rod is

pivoted at each end to allow movement.

It takes up lateral forces between the axle and body thus removing load from the radius arms.

The radius arms have now to only transmit

longitudinal forces.

The Panhard rod is

transmitted

longitudinal forces.

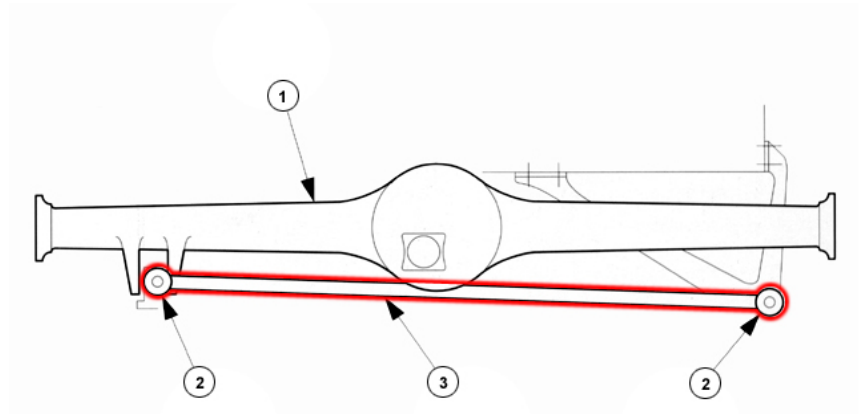

Rear axle with Panhard rod

Summary A wide variety of suspension systems and components are used. Engineers strive to achieve optimum comfort and handling. However, these two main requirements are often at odds with each other. As is common with all vehicle systems, electronic control is one-way developments are now being made.

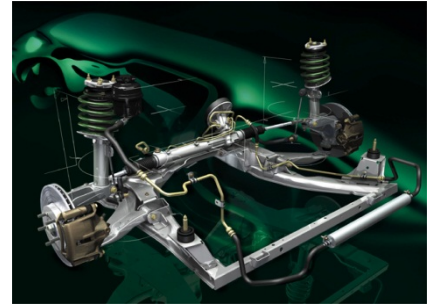

Suspension continues to develop



State the main advantages of independent suspension.



Look back over the previous section and write out a list of the key bullet points here:

SPRINGS

Introduction □□□□ The requirements of the springs can be summarised as follows:

Absorb road shocks from uneven surfaces

Control ground clearance and ride height

Ensure good tyre adhesion

Support the weight of the vehicle

Transmit gravity forces to the wheels.

There are a number of different types of spring in use on modern vehicles.

Coil Springs Although modern vehicles use a number of different types of spring medium, the most popular is the coil (or helical) spring. Coil or helical springs used in vehicle suspension systems, are made from round spring steel bars. The heated bar is wound on a special former and then heat-treated, to obtain the correct elasticity (springiness). The spring can withstand any compression load but not side thrust. It is also difficult for a coil spring to resist braking or driving thrust. Suspension arms are used to resist these loads.



Coil spring in position

Independent Suspension Systems

Coil springs are generally used with independent suspension systems; the springs are usually fitted on each side of the vehicle, between the stub axle assembly and the body. The spring remains in the correct position because recesses are made in both the stub axle assembly and body. The spring is always under compression due to the weight of the vehicle and hence holds itself in place.



Coil spring upper fitting



Coil spring lower fitting

Coil Spring Features The coil spring is a torsion bar wound into a spiral. It can be progressive if the diameter of the spring is tapered conically. A coil spring cannot transmit lateral or longitudinal forces, hence the need for links or arms. It produces little internal damping. No maintenance is required and high travel is possible.



Details of a coil spring

Leaf Springs The leaf spring can provide all the control for the wheels during acceleration, braking, cornering, and general movement caused by the road surface. They are used with fixed axles. Leaf springs can be described as:

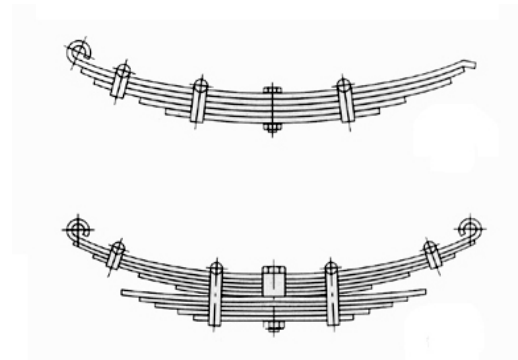

Laminated springs

Laminated or multi-leaf springs

Single leaf or mono-leaf springs.

Multi-Leaf Spring The multi-leaf spring was widely used at the rear of cars and light vehicles, and is still used in commercial vehicle suspension systems. It consists of a number of steel strips or leaves placed on top of each other and then clamped together. The length, cross section, and number of leaves are determined by the loads carried.

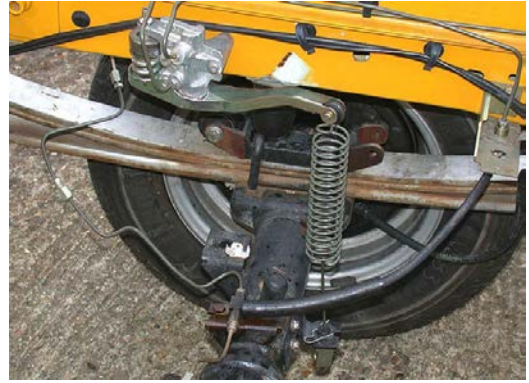

Commercial vehicle leaf spring

Leaf Spring Fixings The top leaf is called the main leaf and each end of this leaf is rolled to form an eye. This is for attachment to the vehicle chassis or body. The leaves of the spring are clamped together by a bolt or pin known as the centre bolt. The spring eye allows movement about a shackle and pin at the rear, allowing the spring to flex. The vehicle is pushed along by the rear axle through the front section of the spring, which is anchored, firmly to the fixed shackle on the vehicle chassis or body. The curve of leaf springs straightens out when a load is applied to it, and its length changes.

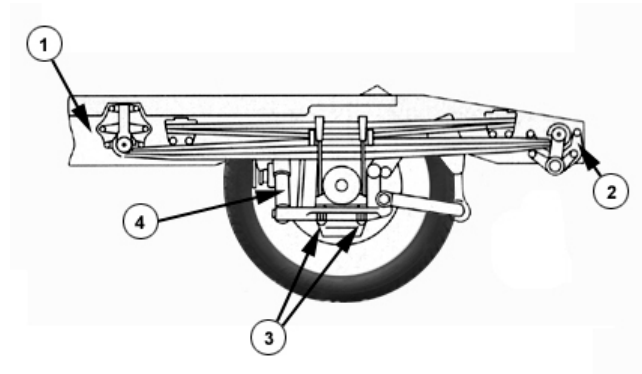

Details of a leaf spring

Shackles Because of the change in length as the spring moves, the rear end of a leaf spring is fixed by a shackle bolt to a swinging shackle. As the road wheel passes over a bump, the spring is compressed and the leaves slide over each other. As it returns to its original shape, the spring forces the wheel back in contact with the road. The leaf spring is usually secured to the axle by means of U bolts. As the leaves of the spring move, they rub together. This produces interleaf friction, which has a damping effect.

Single Leaf Spring A single leaf spring, as the name implies, consists of one uniformly stressed leaf. The spring varies in thickness from a maximum at the centre to a minimum at the spring eyes. This type of leaf spring is made to work in the same way as a multi-leaf spring. Advantages of this type of spring are:



Tapered single leaf

Simplified construction

Constant performance over a period, because interleaf friction is eliminated

Reduction in unsprung mass.

Torsion Bars This type of suspension uses a metal bar, which provides the springing effect as it is twisted. It has the advantage that the components do not take up too much room. The torsion bar can be round or square section, solid or hollow. The surface must be finished accurately to eliminate pressure points, which may cause cracking and fatigue failure. They can be fitted longitudinally or laterally.

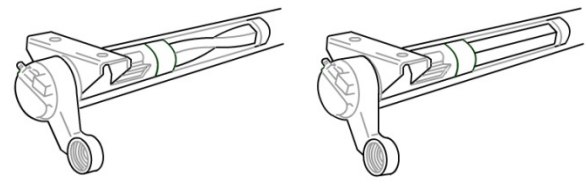

Torsion bar in a guide tube

Torsion Bar Features Torsion bars are maintenance free but can be adjusted. They transmit longitudinal and lateral forces and have low mass. However, they have limited self-damping. Their spring rate is linear rate and life may be limited due to fatigue.

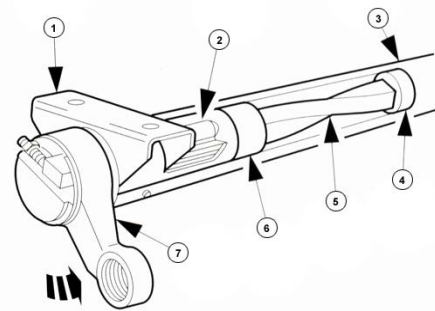

An anti-roll bar is a torsion spring

Pneumatic

Suspension Steel

springs must be stiff enough to carry a vehicle's maximum load. However, this can result in the springs being too stiff to provide consistent ride control and comfort when the vehicle is empty.

Pneumatic suspension can be made self-compensating. It is fitted to many heavy goods vehicles and buses, but is also becoming popular on some off-road light vehicles.

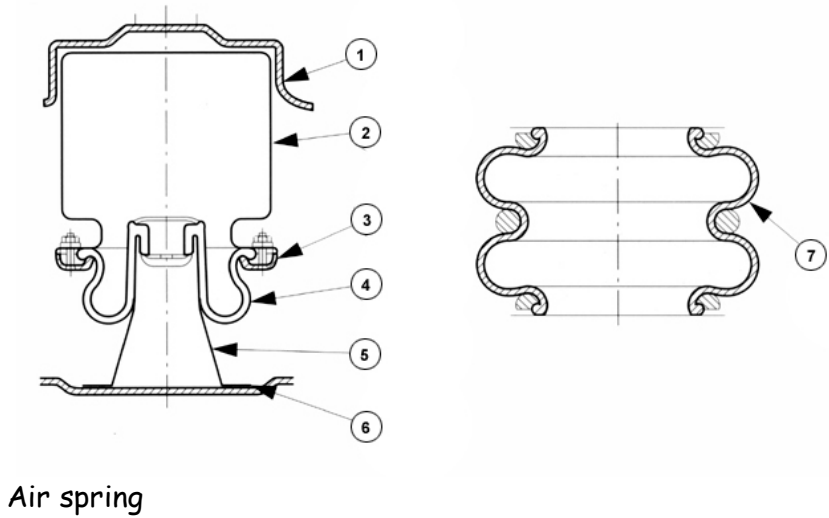

Air Spring System

The pneumatic or air spring is a reinforced rubber bellow fitted between the axle and the chassis or vehicle body. An air compressor is used to increase or decrease the pressure depending on the load in the vehicle. This is done automatically but some manual control can be retained for adjusting the height of the vehicle or stiffness of the suspension. Air springs can be thought of as being like a balloon or football on which the car is supported. The system involves

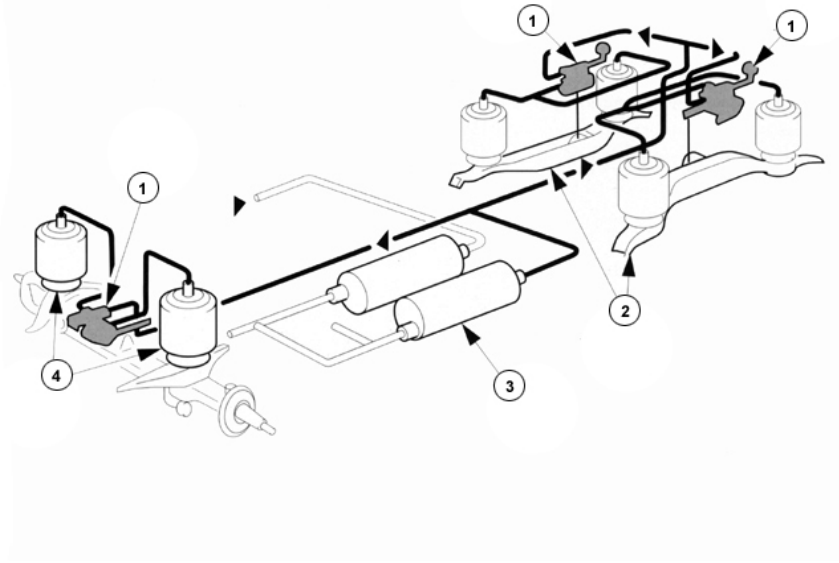

Air spring suspension system

compressors and air tanks. The system

Rubber Springs This is now a very old system, but often old ideas come back! The suspension medium, or spring, is simply a specially shaped piece of rubber. This technique was used on early 'Minis' for example. The rubber did not require damping in most cases. Nowadays rubber springs are only used as a supplement to other forms of springs. They are however popular on trailers and caravans.

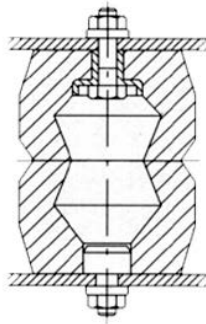

Hollow rubber spring

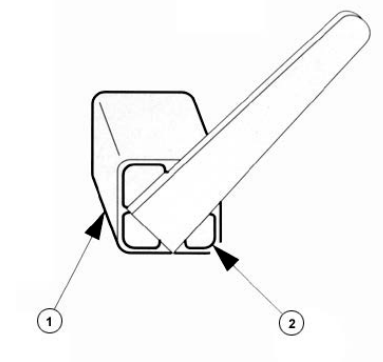

Torsion spring

Hydrolastic Suspension The suspension unit is supported by a rubber spring. Under the spring, a chamber of fluid is connected by a pipe to the corresponding front or rear unit. This system was the forerunner to the hydragas system.

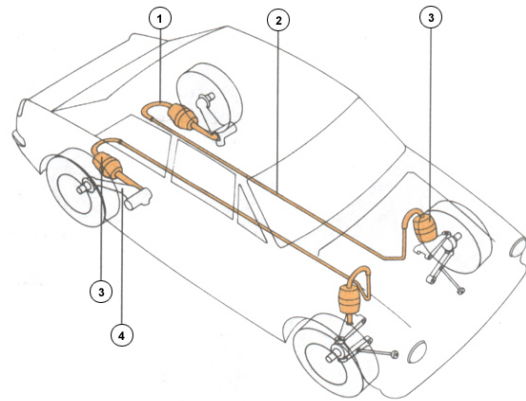

Suspension units are linked by fluid

Hydragas Suspension In the hydragas suspension system, each wheel has a sealed displacer unit. This contains nitrogen gas under very high pressure, which works in much the same way as the steel spring in a conventional system. A damper is also incorporated within the displacer unit. The lower part of the displacer unit is filled with a suspension fluid (a type of wood alcohol usually). The units can be joined by pipes or used individually.

Hydragas Connections

Connecting suspension units, using fluid-filled pipes, helps to improve the ride quality. Linking front to rear makes the rear unit rise as the front unit is compressed by a bump. This tends to keep the vehicle level and reduce pitch. Ride height control can be achieved by pumping oil into or out of the working chamber.

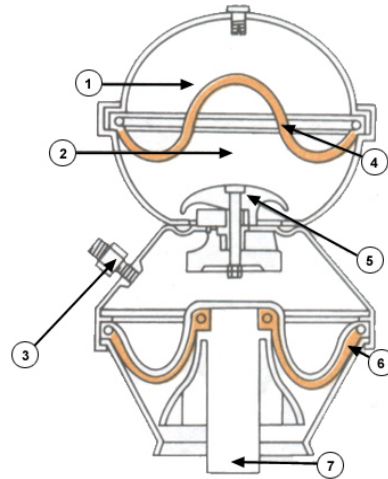

Suspension unit

Summary Suspension springs can be made from a variety of materials and in many different ways. The most common is the coil spring. This is because it has many advantages and is reasonably inexpensive.



Look back over the previous section and write out a list of the key bullet points here:

DAMPERS/SHOCK ABSORBERS

Introduction  As a spring is deflected, energy is stored in it. If the spring is free to move, the energy is released in the form of oscillations, for a short time, before it comes to rest. This principle can be demonstrated by flicking the end of a ruler placed on the edge of a desk. The function of the damper is to absorb the stored energy, which reduces the rebound oscillation. A spring without a damper would build up dangerous and uncomfortable bouncing of the vehicle.

Hydraulic Dampers  Hydraulic dampers are the most common type used on modern vehicles. They work on the principle of forcing fluid through small holes. In a hydraulic damper, the energy in the spring is converted into heat. This is caused as the fluid (a type of oil) is forced rapidly through small holes (orifices). The oil temperature in a damper can reach over 150°C during normal operation. As an example think of using a hand oil pump and how hard it is to make the oil flow quickly.

Damper Functions The functions of a damper can be summarised as follows:



Damper

Ensure directional stability

Ensure good contact between the tyres and the road

Prevent build-up of vertical movements

Reduce oscillations

Reduce wear on tyres and chassis components.

Friction Damper Not used on cars today, but you will find this system used as part of caravan or trailer stabilisers.

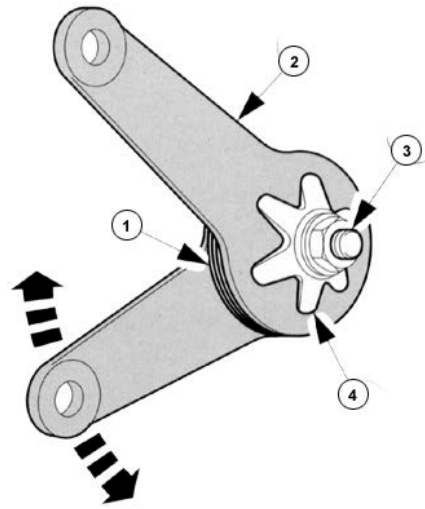

Principle of friction damping

Lever Type Damper A lever-arm damper, which was used on earlier vehicles, works on the same principle as the telescopic type. The lever operates a piston which forces oil into a chamber.

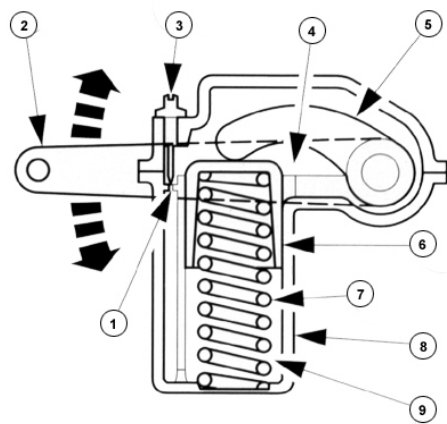

Lever-arm damper

Twin Tube Telescopic Damper This is the most commonly used type of telescopic damper; it consists of two tubes. An outer tube forms a reservoir space and contains the oil displaced from an inner tube. Oil is forced through a valve by the action of a piston as the damper moves up or down. The reservoir space is essential to make up for the changes in volume as the piston rod moves in and out.

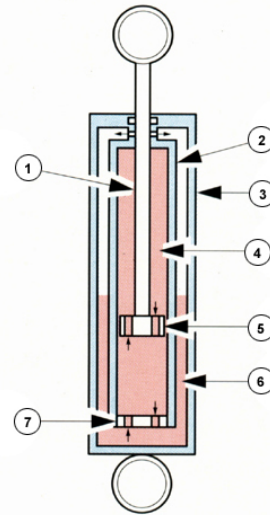

Twin tube system

Single Tube Telescopic Damper

This is often referred to as a gas damper. However, the damping action is still achieved by forcing oil through a restriction. The gas space behind a separator piston is to compensate for the changes in cylinder volume, which is caused as the piston rod moves. The gas is at a pressure of about 25 bar.

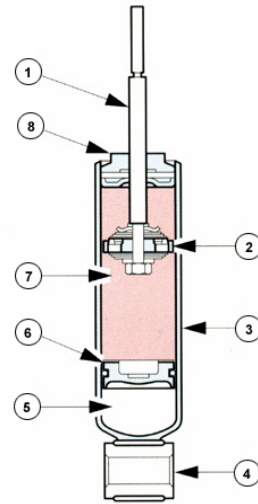

Single tube system

Twin Tube Gas Damper

The twin tube gas damper is an improvement on the well-used twin-tube system. The gas cushion is used in this case to prevent oil foaming. The gas pressure on the oil prevents foaming, which in turn ensures constant operation under all operating conditions. Gas pressure is set at about 5 bar. If bypass grooves are machined in the upper half of the working chamber, the

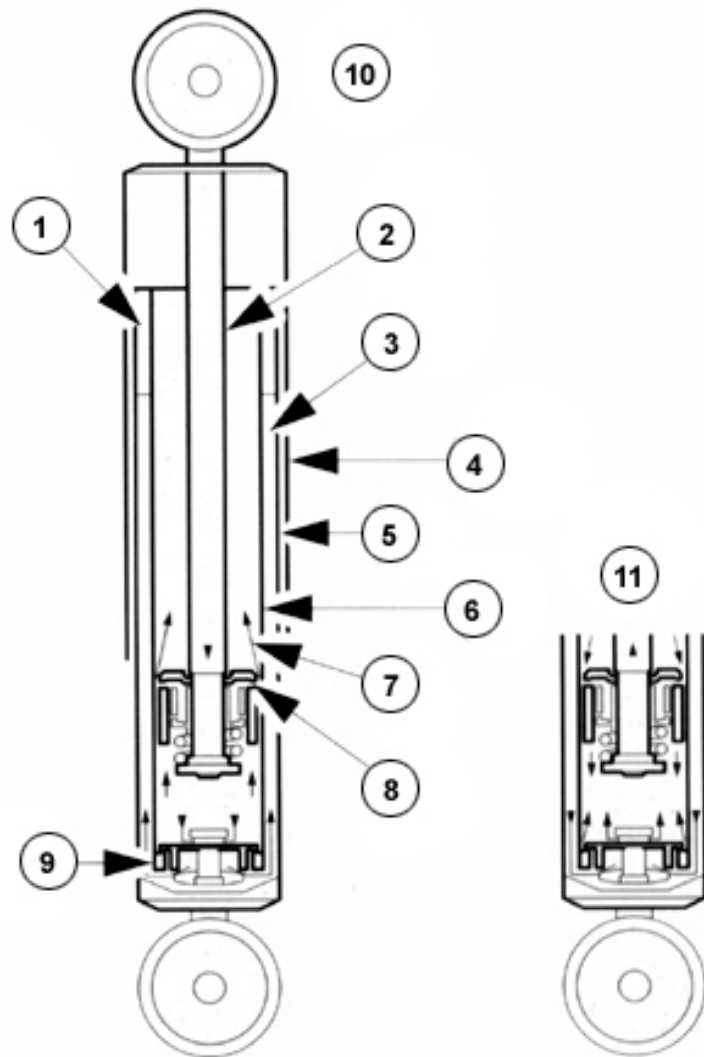

Twin tube gas system

damping rate can be made

Electronically Controlled Dampers These are dampers where the damping rate can be controlled by solenoid valves inside the units. With suitable electronic control, the characteristics can be changed within milliseconds to react to driving and/or load conditions. When it is activated, the solenoid allows some of the oil to be diverted.

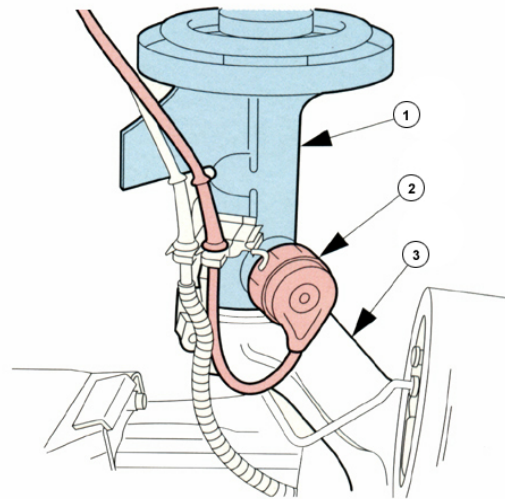

Damper with electronic control

Electronic System Shown

here are the sensors and other components necessary for electronic damper control. Electronic control allows a combination of high comfort and performance. Adjustments can be made automatically or pre-set by the driver.

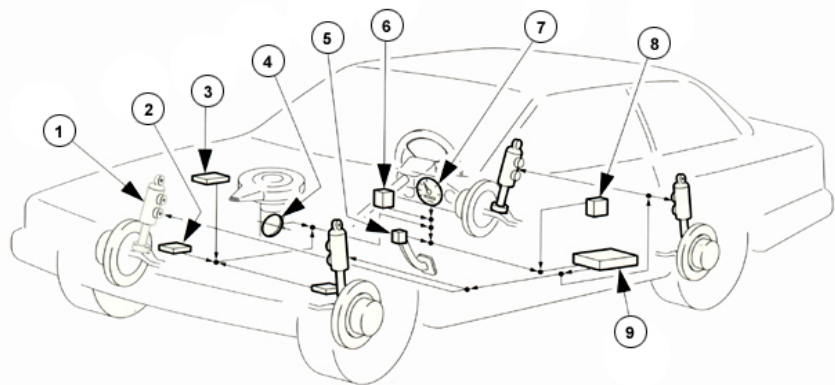

Electronic suspension system

Summary Dampers (or shock absorbers) are used to prevent the suspension springs oscillating. This improves handling, comfort and safety.



Suspension in action



Look back over the previous section and write out a list of the key bullet points here:

TOOLS AND EQUIPMENT

Introduction Components will usually be removed, inspected and repaired or replaced when a defect has been diagnosed. Other components are replaced, or stripped and cleaned, at scheduled mileage or time intervals. Refer to the Routine Maintenance section for details on these items.

Recommended Procedures The descriptions provided in this section deal with the components for individual replacement, rather than as a part of other work. Always refer to a workshop manual before starting work. You will also need to look for the recommended procedure, special tools, materials, tightening sequences and torque settings. Some general and specific tools and pieces of equipment are described on the following screens.



Refer to data as required

Torque Wrench A good torque wrench is an essential piece of equipment. Many types are available but all work on a similar principle. Most are set by adjusting a screwed cylinder, which forms part of the handle. An important point to remember is that, as with any measuring tool, regular calibration is essential to ensure it remains accurate.



A torque wrench is a useful tool

Air Guns The whole point of power tools is that they do the work so you don't have to! Most air guns have an aluminium housing. This material is lightweight but gives long life. Air guns produce a 'hammer' action. Because of this, impact sockets should be used. Normal sockets can shatter under this load. It is important to remember that air tools need lubricating from time to time.

Jacks and Stands Most jacks are simple hydraulic devices. Remember to make sure the safe working load (SWL) is not exceeded. Ensure that any faults with equipment such as this are reported immediately. Axle stands must always be placed under the vehicle supporting the weight - before work is carried out.

Ramps and Hoists Many ramps are available ranging from large four-post wheel-free types to smaller single-post lifts. These large items should be inspected regularly to ensure they are safe.

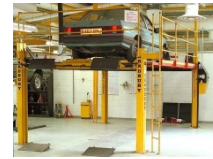

Four post lift
in use



Two post lift
in use

Transmission Jack If a complete gearbox has to be removed, it is likely to be heavy! A transmission jack has attachments that allow you to support the gearbox and lower it safely. The equipment is hydraulically operated just like an ordinary jack. Often, the height can be set by using a foot pedal, which leaves both hands free for positioning the unit.



This jack will support a
gearbox

Bearing Puller Removing some bearings is difficult without a proper puller. For internal bearings, the tool has small legs and feet that hook under the bearing. A threaded section is tightened to pull out the bearing. External pullers hook over the outside of the bearing and a screwed thread is tightened against the shaft.

Air Ratchet These tools are very useful for removing or fitting nuts and bolts. However, it is possible to over tighten if care is not taken. Air tools can be very powerful and will trap your hands! Take adequate precautions at all times.



These tools are very useful

Coil Spring Compressors Springs must be compressed before they are removed from suspension struts. A number of different tools are available. However, the type shown here is very popular. The two clamps are positioned either side of the spring using the hooked ends. The bolts are then tightened evenly until the tension of the spring is taken by the clamps.



McPherson strut springs must be compressed for removal

Ball Joint Presses To remove a taper fitting ball joint, a splitter or press is usually needed. If the joint is to be reused, a lever or clamp type splitter is preferred. The tool clamps onto the arm and threaded section of the joint. A bolt is tightened, which applies a force to push the joint free.



This clamp removes tapered ball joints



Look back over the previous section and write out a list of the key bullet points here:

ROUTINE MAINTENANCE

Scheduled Servicing Scheduled service requirements are often quite simple but none-the-less important. Systems should be checked for correct operation. Adjustments, repairs or replacements are then made if required.

Non-Routine Work When carrying out routine maintenance, some non-routine work may be found. This should be reported to the driver or owner of the vehicle before repairs are carried out.



Report findings to the driver



Worksheet Service suspension

system.

The service requirements for suspension are very simple. Mostly, these involve quick checks for security and leaks.

Some systems may still have lubrication points however, so check with the manufacturer's data. The components that could require replacement, during a service, are the dampers. Replacing the dampers is a straightforward operation on some vehicles. Instructions for these systems follow. However, where the damper forms part of the suspension strut, the task is more complex. Refer to the appropriate worksheet for further instructions.



Front suspension



Damper/shock absorber



Rear suspension



Suspension system

Front Damper

Support the vehicle on a wheel-free hoist allowing the wheels to hang on the suspension. Use a jack or stands to support and adjust the height of the suspension arms as necessary. To remove the front damper it may be necessary to remove a wheel panel for better access. Remove the upper retaining nut. Remove the bolt, or bolts, retaining the lower shock absorber pivot to the suspension arm. If necessary compress the damper by hand and remove it from the vehicle.



This damper is part of the strut



Remove the lower fixing

Installation Prior to installation, place any grommets and washers in position on the upper stem. Insert the stem through the upper mount, push the grommet and washer into place and install the retaining nut. Tighten the nut to the specified torque. Place the lower end of the damper in position and install the bolts. Tighten to the specified torque.



Front strut and damper

Rear Damper

Support the vehicle on a wheel-free hoist allowing the wheels to hang on the suspension. Use a jack or stands to support and adjust the height of the suspension arms as necessary. To remove the lower fixing, use two spanners, if necessary, to undo the stud. Remove the damper stud and nut. Remove the upper through bolt and nut and detach the shock absorber. It may be necessary to compress the damper, but most are easy to remove.



Undo the top fixing



Remove the lower fixing

Installation To install, place the damper in position and fit the retaining nuts and bolts. Tighten the lower fixing to the specified torque. Raise the suspension arm to a normal ride height with a jack. Tighten the upper shock absorber through bolt and nut to the specified torque.



Rear strut and damper

Summary Safety of all road users and pedestrians is essential. Reliable operation of the vehicle is also important. The condition of all systems is therefore vital. Carry out a check at all service intervals.



Safety is important



Look back over the previous section and write out a list of the key bullet points here:

SUSPENSION - CUSTOMER CARE

Vehicle Condition Respect your customer's vehicle and take precautions to keep it clean. Repairing or checking some systems, is likely to involve you working under the vehicle, and then sitting in the driver's seat. Use seat covers and ensure the steering wheel is clean.

Springs and Dampers □□□□ The use your customers have for their vehicles, will determine how much work will be required on the suspension system! A vehicle used off road is more likely to wear the springs and dampers. This is particularly so if the vehicle is not designed for off road use! You may need to explain this to your customers. Regular inspections of the system may be necessary in this case.

Lowering the Suspension Some customers will want you to advise them about lowering the suspension on their vehicle. This is an area where you should be very cautious! Lowering the vehicle can make it look good, but the performance of the steering and suspension will change - not necessarily for the better. Recommend to your customer that only parts designed specifically for their vehicle should be used. If not there is a danger of damage to the vehicle. The insurance may also become invalid. Take care!

Hard Springs and Soft Springs Suspension is always a compromise between comfort and performance. Fitting harder springs and stiffer dampers for example, can improve the way a vehicle handles, but it will be a harsher ride. Softer springs will improve the ride comfort but handling may not be as good. Explain these issues to your customer if necessary.

STEERING

INTRODUCTION TO STEERING

Development of Steering Systems The development of steering systems began before cars were invented. On early cars, the entire front axle was steered by way of a pivot (fifth wheel) situated in the centre of the vehicle. The steering accuracy was not very good, there was a serious risk of overturning and the tyre wear was significant.

Ackermann In 1817, Rudolf Ackermann patented the first stub axle steering system in which each front wheel was fixed to the front axle by a joint. This made it possible to cover a larger curve radius with the wheel on the outside of the curve than with the front wheel on the inside of the curve.

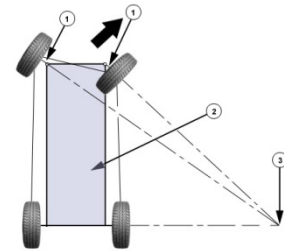

Ackermann steering

Rack And Pinion Steering Rack

and pinion steering was developed at an early age in the history of the car. However, this became more popular, when front-wheel drive was used more, since it requires little space and production costs are lower. The first hydraulic power steering was produced in 1928. However, since there was no great demand for this until the fifties the development of power steering systems stagnated.



Steering rack



Power steering pump

Power Steering Systems Increasing standards of comfort stimulated the demand for power steering systems. Speed-sensitive or variable-assistance power steering (VAPS) systems were developed using electronic controls. These represent the latest major innovation to the steering system in production vehicles. The demand for safety and comfort will lead to further improvements in steering systems.

The Necessity for Steering Systems

Motor vehicles are generally steered via the front wheels, the rear wheels following the front wheels on a smaller radius. With motor vehicles, two factors have to be taken into account:



Steering components

Dead weight or axle loading

Steered wheels' contact area.

Friction Forces □□□ In order to overcome the friction forces more easily, many different types of steering gear have been developed. Power steering in particular, reduces the effort required and increases the safety and comfort. Steering systems must be capable of:

Automatically returning the steered front wheels to the straight-ahead position after cornering (self-centring action)

Translating the steering wheel rotation so that only about two rotations of the steering wheel are necessary for a steering angle of about forty degrees.

Steering and Suspension Steering and suspension must always be regarded as a unit. If the suspension system is not working correctly, it will have a considerable influence on the vehicle's steering characteristics. For example, defective shock absorbers or dampers reduce the wheel contact with the road, limiting the ability to steer the vehicle. The driving safety of a motor vehicle depends largely on the steering. Reliable steering at high speeds is required, together with easy manoeuvrability.

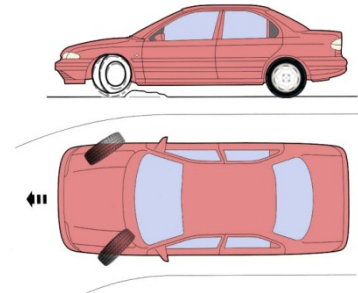

Suspension and steering interact

Manoeuvrability Crucial to the manoeuvrability of a motor vehicle is the turning circle, which in turn is directly dependent on the track circle. Designers strive for the smallest possible track and turning circle. The wheel housing should enclose the wheels as tightly as possible; however, sufficient clearance must be left so that the tyres do not rub when the wheels are turned.

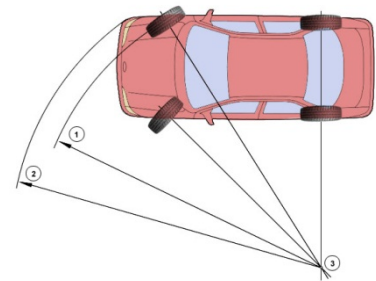

Front axle geometry

Stub Axle Steering □□□ In this type of steering, the stub axle of the steered front wheel is swivelled about the steering axis. When steering, the wheelbase remains constant. The space between the steered wheels can be used for the installation of deep-seated components such as the engine. The low centre of gravity contributes to road handling characteristics. Even at large steering angles, the stability of the vehicle is maintained since the area of support is only slightly reduced.

Steering Trapezium □□□ The 'Trapezium' name is derived from the geometrical shape, which the two steering arms and the track rod form with the front axle. The stub axle and steering arm are firmly connected to one another. The stub axles are swivel mounted on the kingpins or in ball joints. Track rod and steering arms are movably connected to one another. When in the straight-ahead position, track rod and front axle are parallel. When cornering the stub axles are swivelled, thereby turning the front wheels. With the front wheels turned, the track rod is no longer parallel to the front axle. This results in the inside front wheel being turned more than the outside front wheel.



Explain what is meant by stub axle steering.



Look back over the previous section and write out a list of the key bullet points here:

STEERING RACKS AND BOXES

Construction of the Steering System

In order to transmit the steering movements of the driver to the wheels, several components are required. The steering movement is transmitted by way of the steering wheel, shaft, gear and linkage to the front wheels. The rotational movement of the steering wheel is transmitted via the steering shaft to the steering pinion in the steering gear. The steering shaft is supported in the steering column tube, which is fixed to the vehicle body.

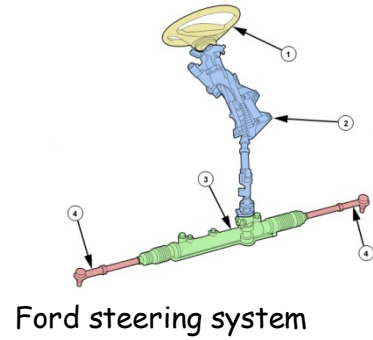

Ford steering system

Steering Gear The steering gear translates (reduces) the steering force applied by the driver. It also converts the rotational movement of the steering wheel into push or pull movements of the track rods. The converted movement is transmitted to the linkage, which in turn moves the wheels in the desired steering direction. Track rods are required to transmit the steering movement from the steering gear to the front wheels. Different track rods are used depending on the type of front axle.

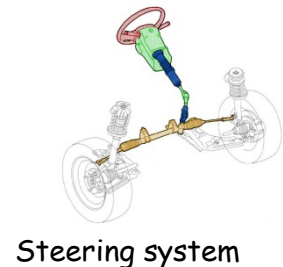

Steering system

One-Piece Track Rod Moved by Drop Arm

This is the simplest design of steering linkage needing only three joints. One-piece track rods we found only with rigid axles since the distance of the steering swivel pins or joints cannot vary.

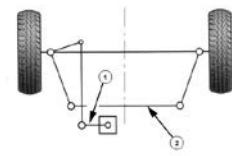

One-piece track rod

Two-Piece Track Rod Moved by Drop Arm

Two-piece track rods may be split centrally or to one side. They are necessary on vehicles with independent suspension, since the suspensions of the steered wheels are compressed independently of one another. The split reduces the effect of bump steering.

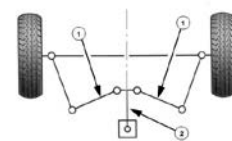

Two-piece track rod

Two-Piece Track Rod Moved by Rack In this type of steering, frequently fitted to light vehicles, the steering linkage is operated by the rack of a rack and pinion gear. Two designs are encountered. The rack either forms part of the track rod or acts directly on the split track rod.

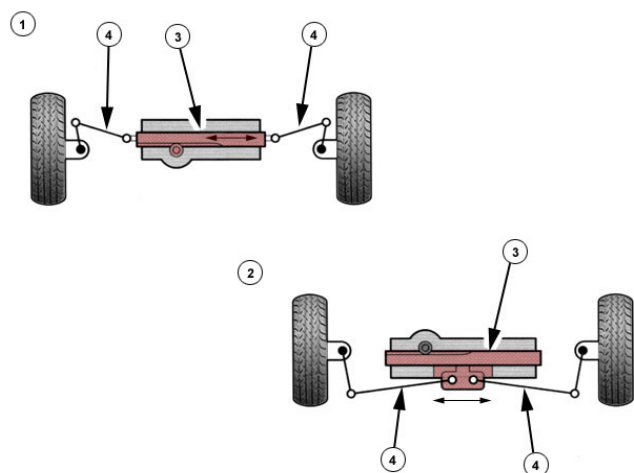

Two-piece track rod

Kingpin The kingpin is the predecessor of the ball joint. It is only fitted in commercial vehicles and a few off-road vehicles, since these generally have rigid front axles in which the distances of the track rods do not vary. The kingpin is not maintenance-free it must be supplied with grease via a grease nipple.

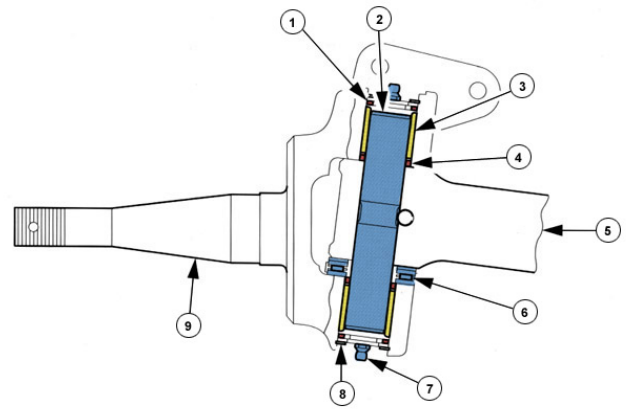

Kingpin on a steered front axle

Ball Joint Ball joints allow parts of the steering linkage to rotate about the longitudinal axis of the ball joint. They also allow limited swivel movements transversely to the longitudinal axis. The lubricated ball pivot is supported in steel cups or between preloaded plastic cups. A gaiter prevents lubricant losses. Ball joints are generally maintenance-free and must always be renewed if the gaiter is damaged.

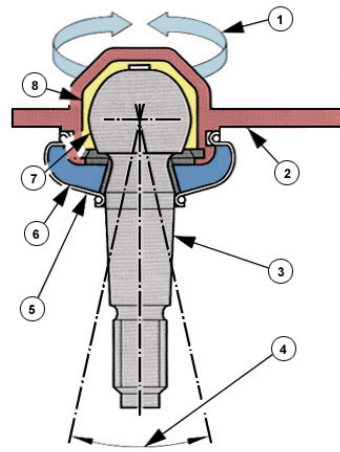

Ball joints are used instead of kingpins

Worm and Nut Steering

Gear This system consists of a steering screw on which the steering nut is displaced axially as the steering wheel is moved. Slide rings on the circumference of the steering nut transmit the movement to the steering fork and thereby to the drop arm. The drop arm performs a movement of up to ninety degrees. In this type of steering the wear is relatively high. The steering nut play cannot be adjusted, and this is a disadvantage. With this type of steering gear, the steering is linear.

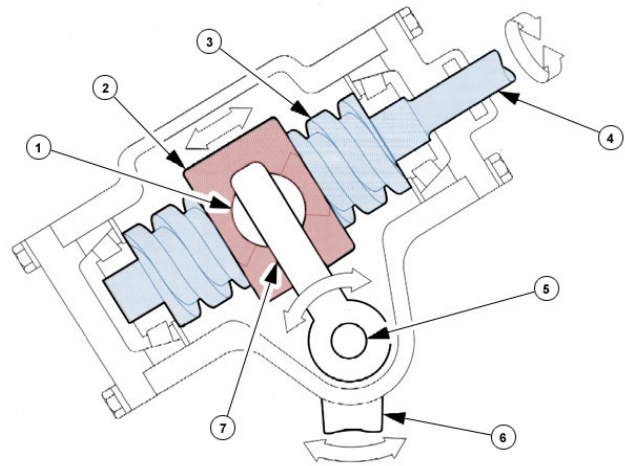

Screw and nut steering box

Recirculating Ball Steering Gear

Owing to the high friction in the screw and nut steering gear, gears with roller friction have become more common. In the recirculating ball steering gear, the steering screw and steering nut have ball groove threads. The threads do not touch one another because they form channels for the balls. When the steering screw is turned, the balls roll in the ball groove thread in two closed recirculating ball races. The balls are returned by two tubes. The drop arm is moved by means of a gear sector. The advantage of the recirculating ball steering gear is that it functions virtually free of wear.

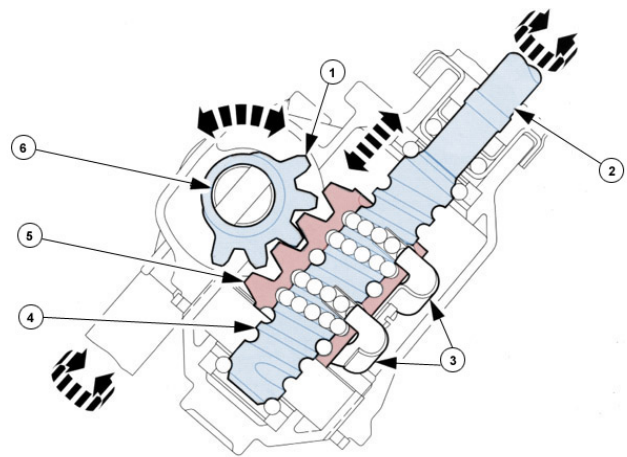

Recirculating ball system

Worm and Sector Steering Gear

The worm and sector steering gear has a cylindrical worm, which due to its screw motion turns a steering sector back and forth. The drop arm is fixed to the sector. It can perform a swivel movement of up to about seventy degrees. Worm steering gears are characterised by high transmission ratios, for example 22:1. One disadvantage is the high wear due to the sliding friction between the sector and the cylindrical worm. In addition, it requires large steering forces. In this type of steering gear, the steering is linear.

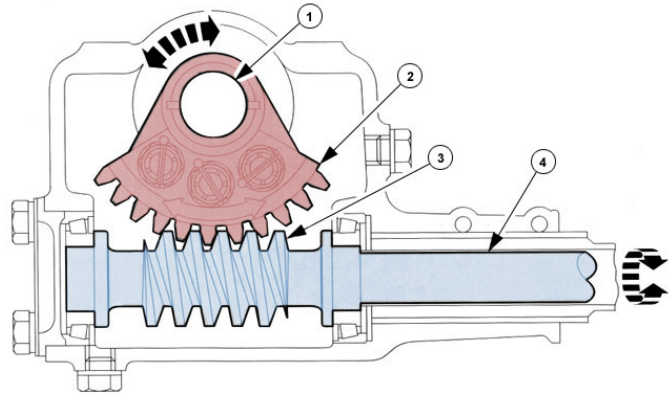

The sector moves with the worm

Worm and Roller Steering Gear

The worm and roller steering gear has a roller instead of the sector. The steering worm is not cylindrical but tapers towards the middle like an hourglass. The roller, driven by the worm, can thus perform a steering movement about its centre when the steering wheel is turned. The drop arm can perform a swivel movement of up to ninety degrees. Advantages include low wear, ease of steering and that a small space is required. The steering play can be adjusted and the steering is free of play when running in a straight line. With this type of steering gear, the steering is linear.

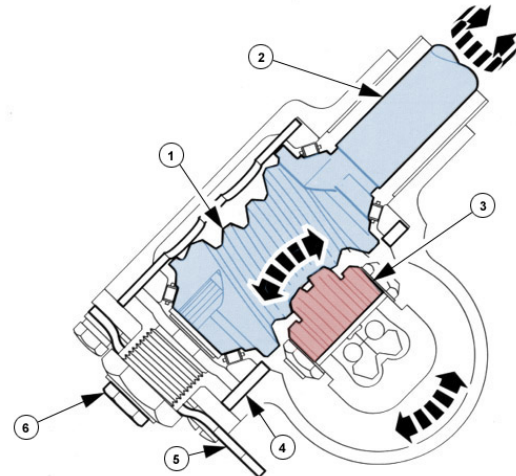

The roller moves with the worm

Worm and Rolling Finger Steering Gear The worm and rolling finger steering gear has a cylindrical screw with an uneven thread pitch. When the worm is rotated, the tapered rolling finger rolls on the flanks of the worm. The rolling finger is displaced. This movement is converted by the shaft into a swivel movement of the drop arm. This system has low wear and ease of steering. The longitudinal play of the worm and the shaft, and the play between rolling finger and worm thread are adjustable. In this type of steering gear, the steering is progressive due to the uneven thread pitch on the worm.

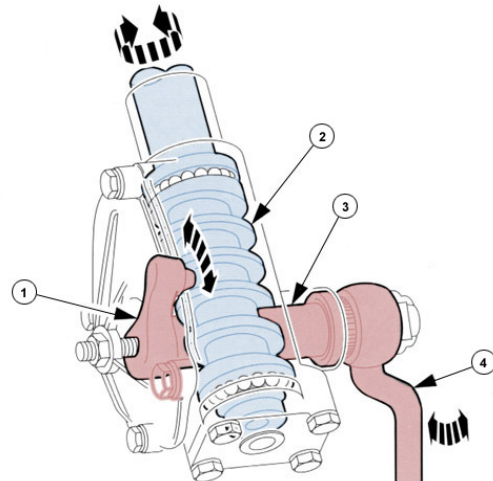

Progressive steering box

Rack and Pinion Steering

The steering rack housing generally contains a helically toothed pinion, which meshes with the rack. By turning the steering wheel and hence the pinion, the rack is displaced transversely to the direction of travel. A spring-loaded pressure pad presses the rack against the pinion. For this reason the steering gear always functions without backlash. At the same time, the sliding friction between pressure pad and rack acts as a damper to absorb road shocks. Advantages of rack and pinion steering include the shallow construction, the very direct steering, the good steering return and the low cost of manufacture.

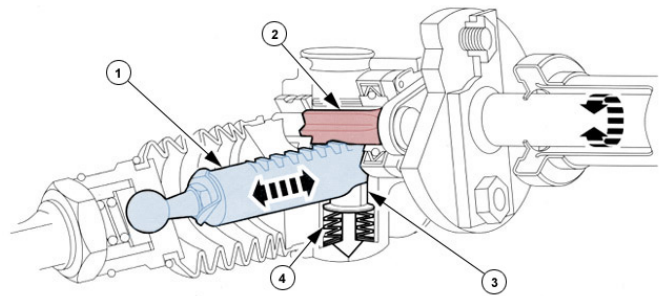

Linear steering rack

Variable Pitch Rack The basic construction and the advantages are similar to those of a rack and pinion steering gear with constant pitch. In a rack and pinion steering gear with variable pitch, a rack is used which has teeth that diminish in size towards the ends. This makes it possible to increase the transmission ratio constantly. This means, in practice, that more steering wheel turns but less effort is required in order to turn the wheels. As a result, the steering moves more easily when applying lock, than when moving in a straight line. This makes parking considerably easier.

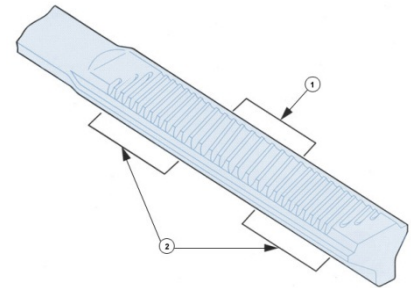

Progressive steering rack

Summary □□□ There is a wide range of steering boxes and steering layouts. On light vehicles, the most common by far, is the steering rack. This is because it has a shallow construction, is very direct, has good steering return and the cost of manufacture is low.



State the main advantages of rack and pinion steering.



Look back over the previous section and write out a list of the key bullet points here:

INTRODUCTION TO POWER STEERING

Introduction The effort required to steer the front wheels depends primarily on the axle load. This is particularly apparent in the following situations:

- Low speed
- Low tyre pressures
- Large tyre contact area
- Tight cornering.

Steering Ratio □□□ Steering ratio cannot be increased too much, because a large number of steering wheel turns would be necessary for the steering movement. Generally, a steering force of 250N should not be exceeded. Therefore, the need arises for power steering in heavy cars, trucks and buses. The power assistance is generally produced by hydraulic pressures. However, electric systems are now becoming popular.

Requirements of Power Steering The requirements of a power steering system are:

Precise onset of power assistance

Maintenance of driver feel

Continued ability to steer should the power system fail.

Hydraulic Power Steering

Hydraulic power assisted steering (PAS) systems use an engine driven pump to supply pressurised fluid. A control valve directs the fluid to a ram that assists with movement of the steering. If the fluid supply or ram fail, the steering works like a manual system.



PAS rack

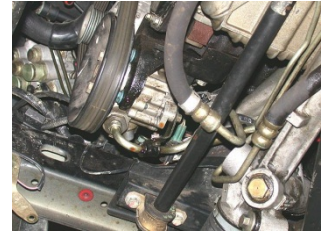

PAS pump

Electric Power Steering Early electric power assisted steering systems used a motor to drive a hydraulic pump. It is now becoming common for the electric motor to act directly on to the steering rack, or the steering shaft.



Electric PAS

Four-Wheel Steering To understand four-wheel steering it is first useful to recall or imagine the effects of rear wheel steering. If you have ever driven, or watched the movement of a forklift truck, you will realise the different effect moving the rear wheels has on vehicle position. This is the same effect on a normal car when reversing - it is why some drivers have trouble reversing into a parking slot or out of a garage! The key point is that the trailing end of the vehicle tends to slew in the direction that the wheels are turned.

Direction of Movement When all four wheels are turned, the overall effect on the vehicle changes again. The effect varies depending on which way the rear wheels are moved. The effects could be described as a turn or a drift. At low speeds, the wheels are turned in opposite directions to improve the drag or slip on the tyres as well as reducing the turning circle. At high speeds, the wheels are turned in the same direction such as for when changing lanes on a motorway. The amount of turn on the rear wheels is much less than the front.

Four-Wheel Steering System

The picture shows the layout of the components on one system in current use. As is common with many, if not all aspects of the vehicle, electronic control is now playing a role in four-wheel steering systems. This is used to determine the amount and direction of rear wheel movement.

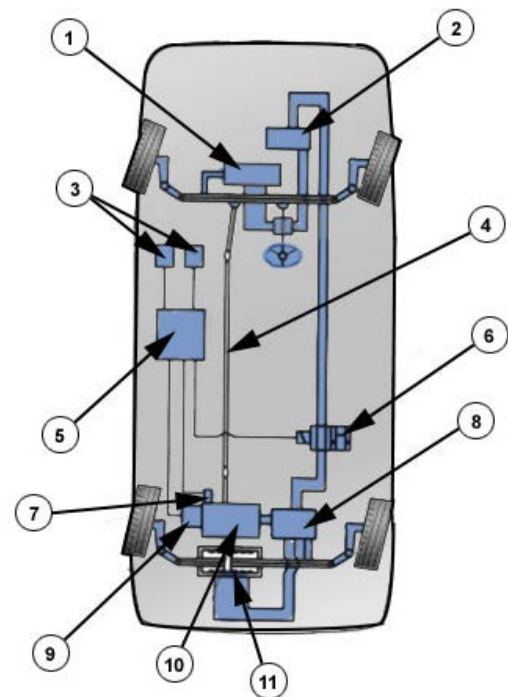

System Components

Summary Power assistance is used to make steering operation easier. This also improves safety. Two sources of 'power assistance' are hydraulic and electric. Hydraulic systems are common but the use of electric systems is increasing. Four-wheel steering systems improve vehicle handling, but are relatively complex and therefore add significant cost to the manufacture of the vehicle.



List THREE ways in which electric motor assisted steering systems operate



Look back over the previous section and write out a list of the key bullet points here:

TOOLS AND EQUIPMENT

Introduction Components will usually be removed, inspected and repaired or replaced when a defect has been diagnosed. Other components are replaced, or stripped and cleaned, at scheduled mileage or time intervals. Refer to the Routine Maintenance Section for details on these items.

Soft Hammers These tools allow a hard blow without causing damage. They are ideal for working on driveshafts, gearboxes and final drive components. Some types are made of special hard plastics whereas some are described as copper/hide mallets. This type has a copper insert on one side and a hide or leather insert on the other. It is still possible to cause damage however, so you must take care!



Some hammers contain metal shot to give a 'dead blow'

Ball Joint Splitter Two types of ball joint splitter are in common use. One type is a simple forked wedge that is hammered in between the joint and the arm. This works well but can damage the joint. If the joint is to be reused, the lever type splitter is preferred. This tool clamps onto the arm and threaded section of the joint. A bolt is tightened, which applies a force to push the joint free.



Wedge type splitter



Lever type splitter

Jacks and Stands Most jacks are simple hydraulic devices. Remember to make sure the safe working load (SWL) is not exceeded. Ensure that any faults with equipment such as this are reported immediately. Axle stands must always be placed under the vehicle supporting the weight - before work is carried out.



Always use stands



After jacking a vehicle

Ramps and Hoists Many types of ramp or hoist are available ranging from large four-post wheel-free types through two post and smaller single-post lifts, to portable devices. These large items should be inspected regularly to ensure they are safe.



Four post lift in use Two post lift



Single post lift



Portable lift

Transmission Jack If a complete gearbox has to be removed, it is likely to be heavy! A transmission jack has attachments that allow you to support the gearbox and lower it safely. The equipment is hydraulically operated just like an ordinary jack. Often, the height can be set by using a foot pedal, which leaves both hands free for positioning the unit.



This jack will support a gearbox

Pullers Removing some bearings is difficult without a proper puller. For internal bearings, the tool has small legs and feet that hook under the bearing. A threaded section is tightened to pull out the bearing. External pullers hook over the outside of the bearing and a screwed thread is tightened against the shaft. A slide hammer is a form of puller. It consists of a steel rod over which a heavy mass slides. The mass is 'hammered' against a stop, thus applying a pulling action.



External puller



Hydraulic puller



Internal puller



Slide hammer

Air Tools The whole point of power tools is that they do the work so you don't have to! Air guns produce a 'hammer' action. Because of this, impact sockets should be used. Normal sockets can shatter under this load. It is important to remember that air tools need lubricating from time to time. Air ratchets are very useful for removing or fitting nuts and bolts. However, it is possible to over tighten if care is not taken. Air tools can be very powerful and will trap your hands!



Air gun



Air drill



Air ratchet



Air chisel

Grease Gun A grease gun is a simple device that pumps grease under pressure. A special connector fits onto a grease nipple. Some types are air operated but this one is pump action.



Look back over the previous section and write out a list of the key bullet points here:

ROUTINE MAINTENANCE

Scheduled Servicing Scheduled service requirements are often quite simple but still important. Systems should be checked for correct operation. Adjustments, repairs or replacements are then made if required. The servicing requirements for the driveshafts are limited but none-the-less important.

Non-Routine Work When carrying out routine maintenance, some non-routine work may be found. This should be reported to the driver or owner of the vehicle before expensive repairs are carried out.



Damaged steering gaiter



Worksheet Service manual

steering system.

Servicing steering systems is a simple task. However, before starting work carry out the basic checks. These are described in the 'Check Steering Components' worksheet. It is important to check for damage, security, wear and leaks. Repair any faults found after reporting them to the customer.



Gaiters



Ball joints



Rack



Column

Manual Steering System Check and top up the steering gearbox oil if appropriate. Check the operation of column adjustment if fitted. Lubricate grease points on swivel joints/kingpins using a grease gun. Lubricate ball joints/track rod ends if appropriate. However, most are sealed for life. A good way to ensure correct operation of the steering is to road test the vehicle.



Greasing swivel joints is only necessary on older cars



Worksheet Service power

assisted steering (PAS) system.

Servicing power assisted steering systems is a simple task. However, before starting work carry out the basic checks. These are described in the 'Check steering components' worksheet. It is important to check for damage, security, wear and leaks. Repair any faults found after reporting them to the customer.

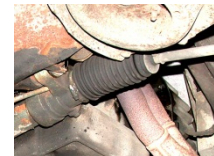

Gaiters



Rack



Ball joints



Column

Hydraulic Power Assisted Steering

Check condition and adjustment of the PAS hydraulic pump drive belt. Renew the belt if necessary and/or adjust. Top up reservoir fluid after checking data for the correct type. Run the engine and turn the steering lock to lock. Check for correct operation and look for signs of leaks. This should not be carried out excessively as it scrubs the tyres. However, it is also a good way of checking pump operation. Check the operation of progressive systems during a road test.



Drive belt test



Fluid tank level



Checking for leaks



Road testing

Electric Power Assisted Steering If an electric system is used, check for cable connection security and fault code read-outs if appropriate. All other checks, such as lubrication and security, are carried out in the same way as for hydraulic systems.

Summary □□ Regular servicing of any system ensures that it will continue to operate the way in which it was intended. Steering systems, power assisted or otherwise, are no exception. Clearly, the safety aspect is of prime importance with steering. A failure at speed would be very dangerous.



Look back over the previous section and write out a list of the key bullet points here:

STEERING - CUSTOMER CARE

Regular Checks Regular servicing is vital for a customer's safety. Carry out checks at all services and report your findings to the customer. Advise customers if anything will need attention before the next scheduled service interval.

Vehicle Condition Respect your customer's vehicle and take precautions to keep it clean. Repairing or checking some systems, is likely to involve you working under the vehicle, and then sitting in the driver's seat. Use seat covers and ensure the steering wheel is clean when you have finished.

Keep Customers Informed Some customers like to know details of what work has been done to their vehicle - and they have every right to know! Keep components that have been replaced, so that they can be inspected by the customer if required. Be willing to explain why parts were changed if necessary. This ball joint was renewed because it had excessive freeplay.

Test Driving ☐☐☐ Take the customer on a test drive if necessary. It is a useful way of helping them to describe problems to you. Alternatively, they could drive and demonstrate what is concerning them. Problems like steering wander can be diagnosed easily in this way.

System Operation Explain how systems work when customers express an interest. You will probably not need to go into detail. However, saying for example, that the engine drives a pump and that this forces fluid into a ram, which then pushes the steering, would be a good way to explain power assistance!

Advise Customers If you notice any unusual tyre wear patterns, they may be caused by driving technique. If your customer asks about why the tyres have worn, you may need to explain. Remember to be tactful!

Summary A customer, who is kept informed and treated with respect, will return and keep you in a job! Explain things to a customer when asked - it will be appreciated.

BRAKES

INTRODUCTION

Energy Conversion □□□ The main purpose of the braking system is simple; it is to slow down or stop a vehicle. To do this the energy in the vehicle movement must be taken away - or converted. This is achieved by creating friction. The resulting heat takes energy away from the movement. In other words, kinetic energy is converted into heat energy.

Vehicle Brakes □□□ The main braking system of a car works by hydraulics. This means that when the driver presses the brake pedal, liquid pressure forces pistons to apply brakes on each wheel. Disc brakes are used on the front wheels of some cars and on all wheels of sports and performance cars. Braking pressure forces brake pads against both sides of a steel disc. Drum brakes are fitted on the rear wheels of some cars and on all wheels of older vehicles. Braking pressure forces shoes to expand outwards into contact with a drum. The important part of brake pads and shoes is the friction lining.

 Brake system

Brake Pads Brake pads are steel backed blocks of friction material, which are pressed onto both sides of the disc. Older types were asbestos based so you must not inhale the dust. Follow manufacturers' recommended procedures. Pads should be changed when the friction material wears down to 2 or 3 mm. The circular steel disc rotates with the wheel. Some are solid but many have ventilation holes.



There are...



Many types of...



Brake pads...



In common use



There are...



Many types of...



Brake shoes...



In common use

Brake Shoes Brake shoes are steel crescent shapes with a friction material lining. They are pressed inside a steel drum, which rotates with the wheel. The rotating action of the brake drum tends to pull one brake shoe harder into contact. This is known as self-servo action. It occurs on the brake shoe, which is after the wheel cylinder, in the direction of wheel rotation. This brake shoe is described as the leading shoe. The brake shoe before the wheel cylinder in the direction of wheel rotation is described as the trailing shoe.

Hydraulic Cylinders

The master cylinder piston is moved by the brake pedal. In its basic form, it is like a pump, which forces brake fluid through the pipes.

Pressure in the pipes causes a small movement to operate either brake shoes or pads. The wheel cylinders work like a pump only in reverse.

 Master cylinder

Brake Servo The brake servo increases the force applied by the driver on the pedal. It makes the brakes more effective. Vacuum, from the engine inlet manifold, is used to work most brake servos.

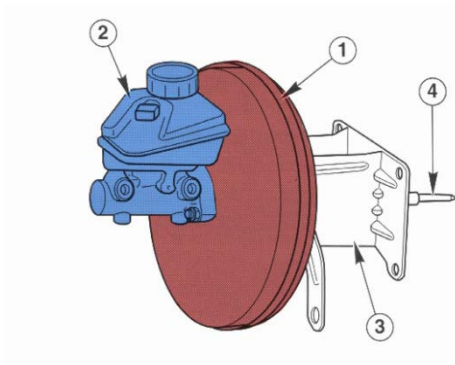

Servo unit

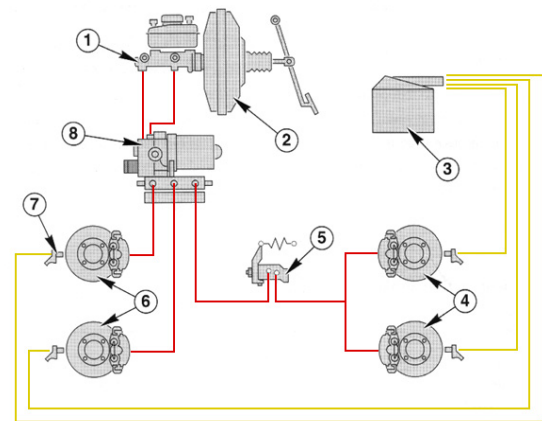

ABS layout

Brake Pipes Strong, high quality pipes are used to connect the master cylinder to the wheel cylinders. Fluid connection, from the vehicle body to the wheels, has to be through flexible pipes to allow suspension and steering movement. As a safety precaution (because brakes are quite important!), brake systems are split into two sections. If one section fails, say by a pipe breaking, the other will continue to operate.



Flexible pipes



Metal pipes

Antilock Brake System If the brakes cause the wheels to lock and make them skid, steering control is lost. In addition, the brakes will not stop the car as quickly. ABS uses electronic control to prevent this happening.

Load Compensation On most car braking systems, about 70% (or more) of the braking force is directed to the front wheels. This is because, under braking, the weight of the vehicle transfers to the front wheels. Load compensation, however, allows the braking pressure to the rear wheels to increase as load in the vehicle increases.

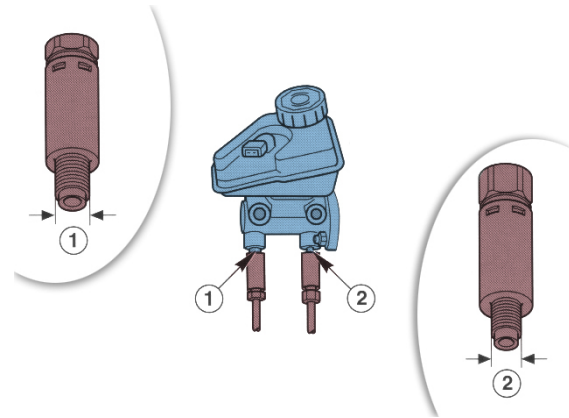

Pressure conscious regulator

Brake Fade If brakes become so hot that they cannot convert energy fast enough, they become much less efficient, or in other words, fade away! This is described as brake fade. A more serious form of brake fade can also be caused if the heat generated is enough to melt the bonding resin in the friction material. This reduces the frictional value of the linings or pads.

Annual Test Requirements □□□ All components of the braking system must be in good working order, in line with most other vehicle systems. Braking efficiency means the braking force compared to the weight of the vehicle. For example, the brakes on a vehicle with a weight of 10 kN (1000 kg x 10 ms⁻² [g]) will provide a braking force of, say, 7 kN. This is said to be 70% efficiency. During an annual test, this is measured on brake rollers. The current efficiency requirements in the UK are as follows:

Service brake efficiency - 50%, Second line brake efficiency - 25%, Parking brake efficiency - 16%.



Describe what is meant by brake fade.



Sketch the basic layout of a hydraulic brake system.



Look back over the previous section and write out a list of the key bullet points here:

DISC, DRUM AND PARKING BRAKES

Disc Brakes The caliper shown is known as a single acting, sliding caliper. This is because only one cylinder is used but the pads are still pressed equally on both sides of the disc by the sliding action. Disc brakes are less prone to brake fade than drum brakes. This is because they are more exposed and can get rid of heat more easily. They also throw off water better than drum brakes. Brake fade occurs when the brakes become so hot they cannot

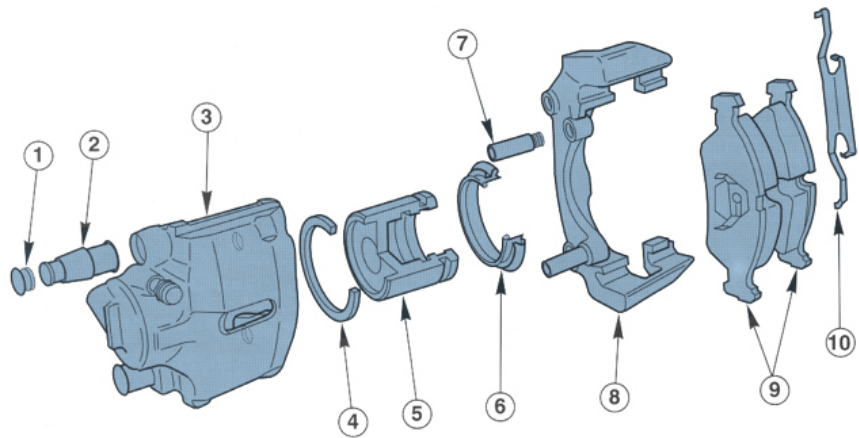

Sliding disc brake caliper components

transfer any more energy - and they

Disc Brake Adjustment □□ Disc brakes are self-adjusting. When the pedal is depressed, the rubber seal is pre-loaded. When the pedal is released, the piston is pulled back due to the elasticity of the rubber sealing ring.



Sliding disc brake caliper

Drum Bakes Brake shoes are mounted inside a cast iron drum. They are mounted on a steel backplate, which is rigidly fixed to a stationary part of the axle. The two curved shoes have friction material on their outer faces.

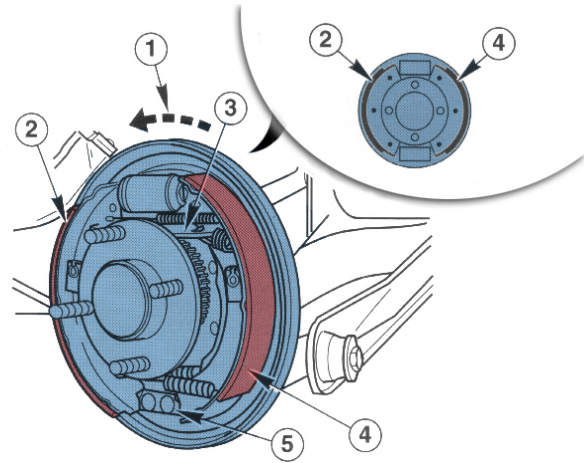

Rear drum brake

One end of each shoe bears on a pivot point. The other end of each shoe is pushed out by the action of a wheel cylinder when the brake pedal is pressed. This puts the brake linings in contact with the drum inner surface. When the brake pedal is released, the return spring pulls the shoes back to their rest position.

Drum Brake Features Drum brakes are more adversely affected by wet and heat than disc brakes, because both water and heat are trapped inside the drum. However, they are easier to fit with a mechanical hand brake linkage.



Brake drum

Brake Adjustments Brakes must be adjusted so that the minimum movement of the pedal starts to apply the brakes. The adjustment in question is the gap between the pads and disc and the shoes and drum. Disc brakes are self-adjusting because as pressure is released it moves the pads just away from the disc. Drum brakes are different because the shoes are moved away from the drum to a set position by a pull off spring. Self-adjusting drum brakes are almost universal now on light vehicles. A common type uses an offset ratchet, which clicks to a wider position if the shoes move beyond a certain amount when operated.

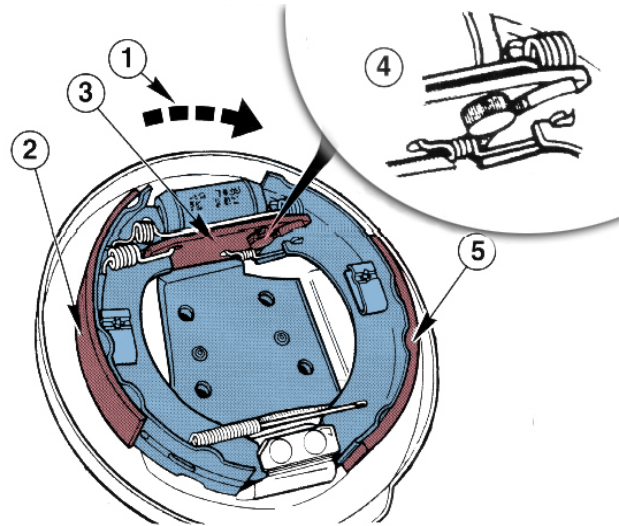

Self-adjusting device

Manual Adjustment

Adjustment through a hole in the back plate is often used. This involves moving a type of nut on a threaded bar, which pushes the shoes out as it is screwed along the thread. This method is similar to the automatic adjusters. An adjustment screw on the back plate is now quite an old method. A screw or square head protruding from the back plate moves the shoes by a snail cam. As a guide, tighten the adjuster until the wheels lock, and then move it back until the wheel is just released. You must ensure that the brakes are not rubbing as this would



Brake adjustment hole



Square type adjuster

build up heat and wear the friction material

Self-Servo Action □□□ The precise way in which the shoes move into contact with the drum affects the power of the brakes. If the shoes are both hinged at the same point then the system is said to have one leading and one trailing shoe. As the shoes are pushed into contact with the drum, the leading shoe is dragged by the drum rotation harder into contact, whereas the rotation tends to push the trailing shoe away. This 'self-servo' action on the leading shoe can be used to increase the power of drum brakes. This is required on the front wheels of all-round drum brake vehicles.

Twin Leading Shoe Brakes The shoes are arranged so that they both experience the self-servo action. The shoes are pivoted at opposite points on the backplate and two wheel cylinders are used. The arrangement is known as twin leading shoe brakes. It is not suitable for use on the rear brakes because if the car is travelling in reverse then it would become a twin trailing shoe arrangement, which means the efficiency of the brakes would be seriously reduced. The leading and trailing layout is therefore used on rear brakes, as one shoe will always be leading no matter in what direction the vehicle is moving.

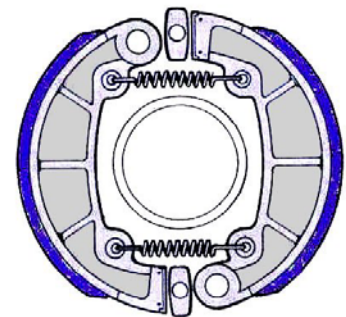

Twin leading shoe system

Leading and Trailing Shoe Brakes The standard layout of drum brake systems is normally:

Twin leading shoe brakes on the front wheels
Leading and trailing shoe brakes on the rear wheels.

Disc brakes are now used on the front wheels of all light vehicles but many retain leading and trailing shoe brakes on the rear. In most cases, it is easier to attach a handbrake linkage to the system with shoes on the rear. This method will also provide the braking performance required when the vehicle is reversing.

Hand Brake Linkages Inside a brake drum, the hand brake linkage is usually a lever mechanism as shown here. This lever pushes the shoes against the drum and locks the wheel. The hand brake lever pulls on one or more cables and has a ratchet to allow it to be locked in the on position. There are a number of ways in which the hand brake linkage can be laid out to provide equal force, or compensation, for both wheels:

- Two cables, one to each wheel
- Equaliser on a single cable pulling a 'U' section to balance effort through the rear cable (as shown here)
- Single cable to a small linkage on the rear axle.



Leading and trailing system

Disc Type Handbrake Some sliding caliper disc brakes incorporate a handbrake mechanism. The footbrake operates as normal. Handbrake operation is by a moving lever. The lever acts through a shaft and cam, which works on the adjusting screw of the piston. The piston presses one pad against the disc and because of the sliding action, the other pad also moves.

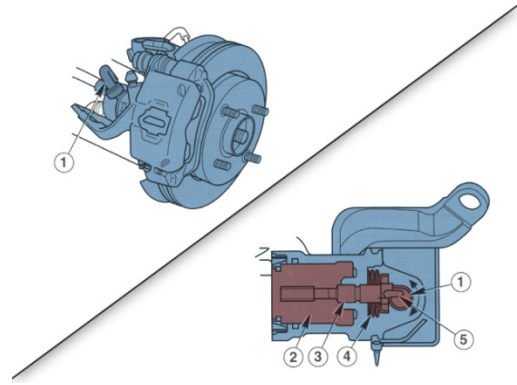

Sliding caliper parking brake

Handbrake Drum in Disc Some manufacturers use a set of small brake shoes inside a small drum, which is built in to the brake disc. The caliper is operated as normal by the footbrake. The small shoes are moved by a cable and lever.

Summary In summary, remember that the purpose of the braking system is to slow down or stop a vehicle. This is achieved by converting the vehicle's movement energy into heat. Friction is used to do this. Braking system developments have improved efficiency, reliability and ease of servicing.

 Describe the leading/trailing layout of the shoes on drum brake systems when used front and rear.

 State why disc brakes are self-adjusting

 Look back over the previous section and write out a list of the key bullet points here:

HYDRAULIC COMPONENTS

Principle of Hydraulic Braking  Shown here, is the principle of hydraulic brakes. The movement of the piston, labelled 2, causes an equal force in all parts of the system. The pistons, labelled 1, move a shorter distance. If larger area pistons are used, the force at the brakes can be increased. This is called a liquid lever and acts in addition to the leverage of the brake pedal.

Braking System A

complete braking system includes a master cylinder, which operates several wheel cylinders. The system is designed to give the power amplification needed for braking the particular vehicle. On any vehicle when braking, a lot of the weight is transferred to the front wheels. Most braking effort is therefore designed to work on the front brakes. Some cars have special hydraulic valves to limit rear wheel braking. This reduces the chance of the rear wheels locking and skidding.

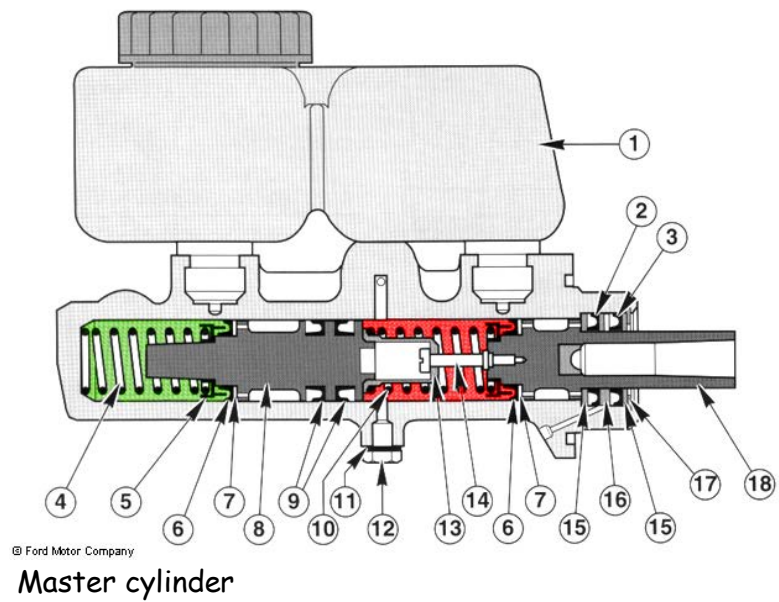

Wheel Cylinders Brake shoes can be moved by double or single-acting wheel cylinders. A common layout is to use one double acting cylinder and brake shoes on each rear wheel of the vehicle, and disc brakes on the front wheels. A double acting cylinder simply means that as fluid pressure acts through a centre inlet, pistons are forced out of both ends.

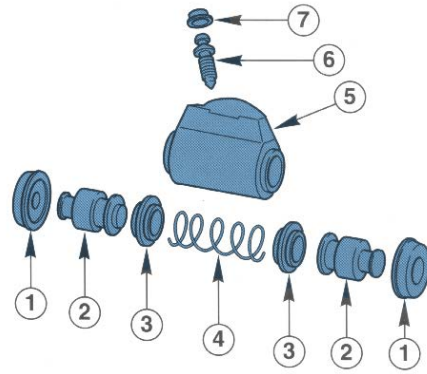

Slave cylinder components

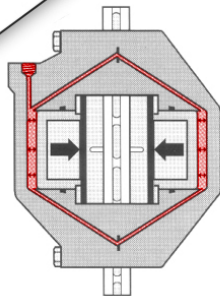
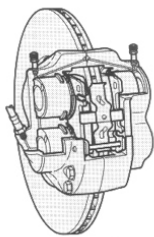

Fixed caliper

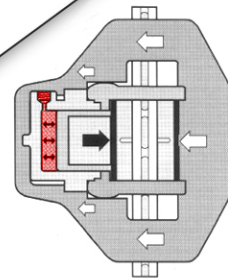
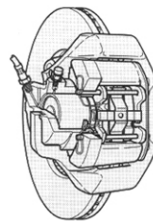

Floating caliper

Disc Caliper Piston Disc

brake calipers are known as fixed, floating or sliding types. The pistons are moved by hydraulic pressure created in the master cylinder. A number of different calipers are used. Some high performance calipers include up to four pistons. However, the operating principle remains the same.

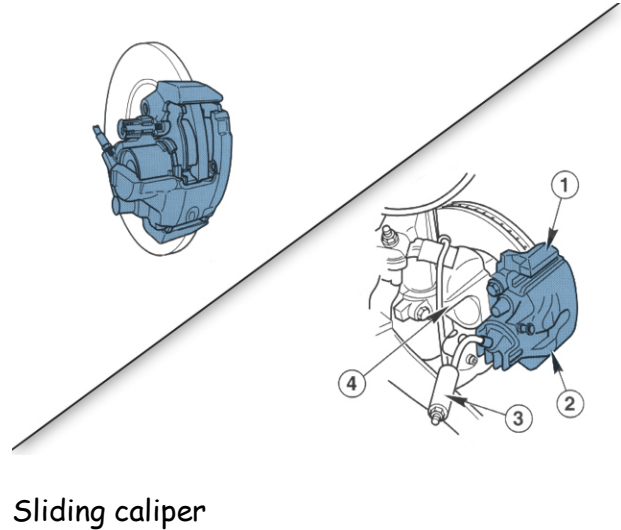

Brake Fluid Always use new and approved brake fluid when topping up or refilling the system. Manufacturers' recommendations must always be followed. Brake fluid is hygroscopic, which means that over time, it absorbs water. This increases the risk of the fluid boiling due to the heat from the brakes. Pockets of steam in the system would not allow full braking pressure to be applied. Many manufacturers recommend that the fluid be changed at regular intervals. Make sure the correct grade of fluid is used. The current recommended types are known as DOT4 and DOT5.



A common type of brake fluid

Brake System Shown here are the main parts of a typical modern braking system. A separate mechanical system is a good safety feature. Most vehicles have the mechanical parking brake working on the rear wheels but a few have it working on the front - take care. Note the importance of flexible connections to allow for suspension and steering movement. These flexible pipes are made of high quality rubber and are covered in layers of strong mesh to prevent expansion when under pressure.



Braking and other components

Tandem Master Cylinder □□ Safety is built into braking systems by using a double acting master cylinder. This is often described as tandem and can be thought of as two master cylinders inside one housing. The pressure from the pedal acts on both cylinders but fluid cannot pass from one to the other. Each cylinder is then connected to a separate circuit. These split lines can be connected in a number of ways. Under normal operating conditions, the pressure developed in the first part of the master cylinder is transmitted to the second. This is because the fluid in the first chamber acts directly on the second piston.

✎ Master cylinder operation

Circuit Failure  If one line fails, the first piston meets no restriction and closes up to the second piston. Further movement will now provide pressure for the second circuit. The driver will notice that pedal travel increases, but some braking performance will remain. If the fluid leak is from the second circuit, then the second piston will meet no restriction and close up the gap. Braking will now be just from the first circuit. Diagonal split brakes are the most common and are used on vehicles with a negative scrub radius. Steering control is maintained under brake failure conditions.

Multi-Circuit Systems There are three common 'splits' used on modern braking systems. The first two types listed are the most common:

- Diagonal split type, where if a fault occurs, the driver loses half of the front and half of the rear brakes
- Separate front and rear, where if a fault occurs, the driver loses all of the front or all of the rear brakes
- Duplicated front, where if a fault occurs, the driver loses the rear and part of the front or part of the front brakes only. Special front calipers are required when using this method.

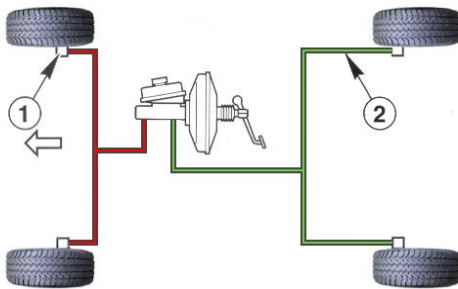

Front/rear split

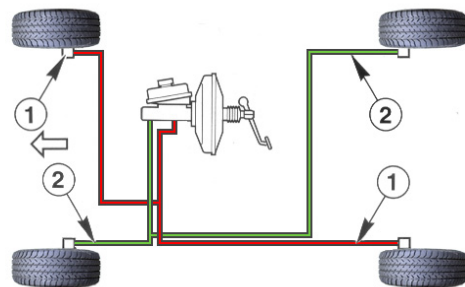

Diagonal split

 State the three common 'splits' used on modern braking systems AND advantages of each type.

 Describe the operation of a sliding caliper disc brake

 Look back over the previous section and write out a list of the key bullet points here:

TOOLS AND EQUIPMENT

Introduction Components will usually be removed, inspected and repaired or replaced when a defect has been diagnosed. Other components are replaced, or stripped and cleaned, at scheduled mileage or time intervals. Refer to the Routine Maintenance Section for details on these items.

Recommended Procedures The descriptions provided in this section deal with the components for individual replacement, rather than as a part of other work. Always refer to a

workshop manual before starting work. You will also need to look for the recommended procedure, special tools, materials, tightening sequences and torque settings. Some general and specific tools and pieces of equipment are described on the following screens.

General Toolkit General tools and equipment will be required for most tasks. As your career develops you will build a collection of tools and equipment. Look after your tools and they will look after you!

Torque Wrench A good torque wrench is an essential piece of equipment. Many types are available but all work on a similar principle. Most are set by adjusting a screwed cylinder, which forms part of the handle. An important point to remember is that, as with any measuring tool, regular calibration is essential to ensure it remains accurate.



A torque wrench is a useful tool

Air Guns The whole point of power tools is that they do the work so you don't have to! Most air guns have an aluminium housing. This material is lightweight and gives long life. Air guns produce a 'hammer' action. Because of this, impact sockets should be used. Normal sockets



Wheel gun

can shatter under this load. It is important to remember that air tools need lubricating from time to time.

Jacks and Stands Most jacks are simple hydraulic devices. Remember to make sure the safe working load (SWL) is not exceeded. Ensure that any faults with equipment such as this are reported immediately. Axle stands must always be placed under the vehicle supporting the weight - before work is carried out.



Always use stands...



After jacking a vehicle

Ramps and Hoists Many ramps are available ranging from large four-post wheel-free types to smaller single-post lifts. These large items should be inspected regularly to ensure they are safe.



Four post lift in use



Two post lift in use

Air Ratchet These tools are very useful for removing or fitting nuts and bolts. However, it is possible to over tighten if care is not taken. Air tools can be very powerful and will trap your hands! Take adequate precautions at all times.



These tools are very useful

Pipe Clamp A pipe clamp is used to block a pipe for tests or repairs to be carried out. For example, on a



braking system, it can be used to prevent leakage of fluid when cylinders are replaced. Alternatively, the source of spongy brakes can be narrowed down. This is done by clamping each flexible pipe in turn and pressing the pedal. However, some manufacturers do not recommend these tools because the pipe can be damaged.

Only use recommended types

Pressure Bleeder This equipment forces fluid through the reservoir under pressure. The tank is in two parts, separated by a diaphragm. The top of the tank is filled with new brake fluid, and the lower part pressurised with compressed air. Using suitable adaptors, the outlet pipe, from the fluid section, is connected to the master cylinder reservoir. A valve is opened and fluid is force out of the slave cylinders as the bleed nipples are opened. Fluid is collected in a container using a simple rubber pipe, just like when bleeding the system manually.



This equipment forces fluid through the reservoir

Honing Tool A honing tool is sometimes called a 'glaze buster'. It is used to grind the inside of a cylinder to a good, final finish. This can be done to an engine cylinder or a much



Engine cylinder honing tool

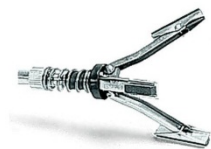

Brake cylinder honing tool

smaller hydraulic brake cylinder. The tool is usually mounted in an air drill as the power source. Lubrication should be used when the equipment is operated.

Brake Adjusting Tools On many earlier braking systems, the adjustment (gap between the shoe and drum) had to be adjusted manually during a service. Most modern systems do this automatically. However, many earlier systems are still in use so tools such as these, which are used to rotate a gear inside the drum, will be very useful. Some are made to suit particular manufacturer's systems.



These tools are simple levers



Look back over the previous section and write out a list of the key bullet points here:

ROUTINE MAINTENANCE

Scheduled Servicing Scheduled service requirements are often quite simple but none-the-less important. Systems

should be checked for correct operation. Adjustments, repairs or replacements are then made if required.



Worksheet Service front disc



Checking the pad lining thickness

brakes.

Jack up and support the vehicle on stands or use a suitable hoist. Remove the appropriate wheels to allow inspection of the brake pads. Recommendations vary, but in most cases, the pads should be replaced if the lining is less than 1.5 mm.

Caliper and Piston Removal Methods of pad removal differ, so check the manufacturer's latest data. However, most types are quite simple. The method described here relates to the type where part of the caliper is removed. Turn the steering to a 'lock' position, which allows easier access to the caliper and pads. Wash the caliper and pad assembly using a proprietary brake cleaner or suitable extractor. If necessary, remove some brake fluid from the reservoir. This is because when the piston is pushed back to allow new pads to be fitted, fluid can overflow.

Brake Pad Removal If a retaining bolt clip is fitted, it should be removed. Undo both caliper piston fixing bolts. Many types

require an Allen key. Rock the assembly from side to side. This moves the pads and pushes the piston in, just far enough to allow the caliper piston to be removed. Withdraw the pads, using a small lever to help, if a spring clip holds one of the pads into the piston. Keep the pads to show to the customer if necessary and then dispose of them in line with current regulations. Examine the disc for grooves and corrosion.

Refitting the Pads Use a G/C clamp to push the caliper piston fully home. Fit the new pads in position together with anti-squeal shims if they are used. Some manufacturers recommend that copper grease be applied to the back and sides of each pad. However, take care not to contaminate the lining material. Pads on both sides of the vehicle must always be replaced as a set. Refit the caliper and tighten both bolts to the recommended torque. Pump the brake pedal until it feels hard. This is to make sure the pads are moved fully into position. Double check correct operation and then refit the road wheels. Lower the vehicle to the ground. Road test to ensure correct operation.



Worksheet Service rear drum

brakes.

Jack up and support the vehicle on



Rear brake shoes and drum

stands or use a suitable hoist. Remove the appropriate wheels and release the parking brake. Remove the cap that protects the hub nut and remove the locking tab or pin if used. Undo the nut and remove the outer bearing. Now remove the drum together with the inner bearing. Alternatively, remove the drum fixing screw and remove the drum.

Removing Brake Shoes Wash the backplate, shoes and drum assembly using a proprietary brake cleaner or suitable extractor. Inspect the brake shoes; recommendations vary slightly but in most cases, the shoes should be replaced if the lining is less than about 1.5mm. Methods of shoe removal also vary so check the manufacturer's data. Remove the shoe hold-down fixings if fitted. These usually twist or pull free. Note the position of the shoe return springs and remove them with a special brake spring tool. Remove the handbrake cable. On some vehicles, the shoes can be removed together with the handbrake cable, adjuster and return springs, which can then be taken off.

Refitting Brake Shoes Check the wheel cylinders for leaks by peeling back the dust seals. The cylinders should be overhauled or replaced if leaks are



detected. Discard the old shoes in line with current regulations but keep them for the customer to examine if necessary. Clean off the backplate and apply special grease to the shoe contact points. Do not use ordinary grease; it will not stand the high temperatures. Fit the return springs and adjuster to the new shoes. Fit the shoes to the backplate, making sure they fit into the lower pivot and wheel cylinder slots. Use a shoe retractor to lever the shoes in to place. Refit the handbrake cable and shoe hold-down clips.

Check cylinders



Refit the shoes

Testing the Brakes Refit the drum, bearings and nut; tighten to the correct torque. Alternatively, refit the drum and fixing screw if used. Pump the brake pedal until it feels hard. This is to make sure the shoes are adjusted and moved fully into position. Check for correct fitment and that the drum spins freely, then refit the road wheels. Lower the vehicle to the ground. Road test to ensure correct operation. Remember to check the handbrake works correctly and adjust the cable if necessary.

Summary □□ Safety of all road users and pedestrians is essential. Reliable operation of the vehicle is also important.

The condition of all systems is therefore vital. Carry out a check at all service intervals.



Look back over the previous section and write out a list of the key bullet points here:

BRAKES - CUSTOMER CARE

Regular Checks Regular servicing is vital for a customer's safety. Carry out checks at all services and report your findings to the customer. Advise customers if anything will need attention before the next scheduled service interval.

Vehicle Condition Respect your customer's vehicle and take precautions to keep it clean. Repairing or checking some systems, is likely to involve you working under the vehicle, and then sitting in the driver's seat. Use seat covers and ensure the steering wheel is clean when you have finished.

Driving Style Your customer may comment that their brake linings have worn out more quickly than they should. This could be due to a mechanical fault such as incorrect adjustment, so check carefully. However, it is possible that driving style is to blame - you may need to mention this tactfully!

Braking In Reverse On some vehicles, brakes when reversing are not as efficient as when driving forwards. This is because some systems use twin leading shoes on the front. In the forward direction, both shoes have a self-servo action.

However, when reversing, both shoes have just the opposite and do not work efficiently. This is an issue only on older vehicles, but it may be necessary to explain it to some customers.

Upgraded Brakes Upgraded braking components are available for fitting in the aftermarket or for performance applications. The materials used are very efficient, often very expensive, and can wear out quickly. Make your customers aware of this if they enquire!



High performance pads and disc

Summary A customer who is kept informed and treated with respect will return and keep you in a job! Explain things to a customer when asked - it will be appreciated. Look after the vehicle as if it were your own.

WHEELS AND TYRES

TYPES OF WHEEL

Introduction Together with the tyre, a road wheel must support the weight of the vehicle. It must also be capable of withstanding a number of side thrusts when cornering, and torsional forces when driving. Road wheels must be strong, but light weight. They must be cheap to produce, easy to clean, and simple to remove and refit.

Spoked Wheels Spoked wheels are attractive but tend only to be used on older sports cars. They are a smaller diameter, but stronger version, of a bike wheel. These wheels must have tyres with an inner tube. Spoked wheels allow good ventilation and cooling for the brakes but can be difficult to keep clean!

Pressed Steel Wheels The centre of this type of wheel is made by pressing a disc into a dish shape, to give it greater strength. The rim is a rolled section, which is circled and welded. The rim is normally welded to the flange of the centre disc. The centre disc has a number of slots under the rim. This is to allow ventilation for the brakes as well as the wheel itself.



Standard wheel used on many cars

Steel Wheel Rim Features The manufacture of this type of wheel makes it cheap to produce and strong. The bead of a tyre is made from wire, which cannot be stretched for fitting or removal. The wheel rim therefore, must be designed to allow the tyre to be held in place, but also allow for easy removal.

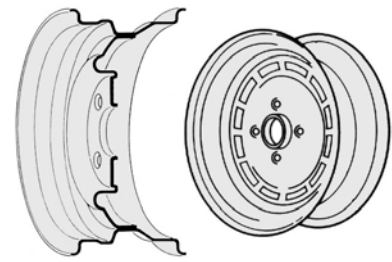

Standard wheel design

'Well-Base' Wheel To facilitate fitting and removal a 'well-base' is manufactured into the rim. For tyre removal, one bead must be forced into the well. This then allows the other bead to be levered over the edge of the rim. The bead seats are made with a taper so that as the tyre is inflated the bead is forced up the taper by the air pressure. This locks the tyre on to the rim making a good seal.

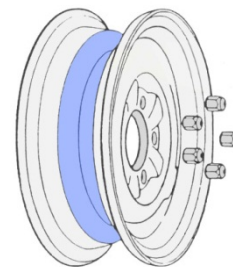

Wheel profile

Wheel Trims Steel wheels are a very popular design. They are very strong and cheap to produce. Steel wheels are usually covered with plastic wheel trims. Trims are available in many different styles.



Wheel trims...



Many shapes...



Come in...



And sizes

Alloy Wheels Alloy wheels, or 'alloys', are good, attractive looking wheels. They tend to be fitted to higher specification vehicles. Many designs are used. They are light weight but can be difficult to clean.



Alloys...



Many shapes...



Come in...



And sizes

Cast Alloy Wheels A large number of vehicles are fitted with wheels made from alloy. Wheels of this type are generally produced from aluminium alloy castings, which are then machine finished. Alloy wheels can be easily damaged by 'kerbing'!



Damaged alloy wheel

Advantages of Alloy Wheels The main advantage of cast alloy road wheels is their reduced weight, and of course, they look good. Disadvantages are their lower resistance to corrosion, and that they are more prone to accidental damage. The general shape of the wheel, as far as tyre fitting is concerned, is much the same as the pressed steel type.

Split Rims Many commercial vehicles use split rims, either of a two, or three-piece construction. The tyre is held in place, by what could be described as, a very large circlip. Do not remove or fit tyres on this type of wheel unless you have received proper instruction.

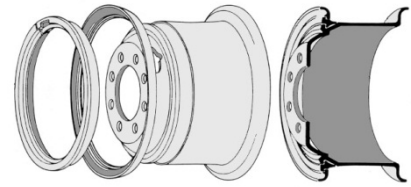

Do not work on split rims unless trained

Divided Rims On a few specialist vehicles, the rims are made in two halves, which are bolted together. The nuts and bolts holding them together should be specially marked. Undoing them with the tyre inflated would be very dangerous.

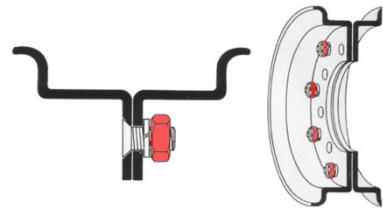

Do not work on divided rims unless trained

Temporary or 'Space Saver' Wheels In order to save space in the boot and to save on costs, some cars with large and expensive alloy wheels use a small thin steel wheel as the spare. The speed of the vehicle is restricted when this type of wheel is used. It is only intended for emergency use.

 Explain why a 'well' is made into a wheel rim.

 State THREE advantages of alloy wheels

 Look back over the previous section and write out a list of the key bullet points here:

WHEEL RIMS AND FIXINGS

Fixing the Road Wheels Light vehicle road wheels are usually held in place by four nuts or bolts. The fixing holes in the wheels are stamped or machined to form a cone shaped seat.



Ten...



Five...



Six...



Four stud fixings

Wheel Nuts and Bolts The wheel nut or bolt heads, fit into this seat. This ensures that the wheel fits in exactly the right position. In the case of the steel pressed wheels, it also strengthens the wheel centre round the stud holes.

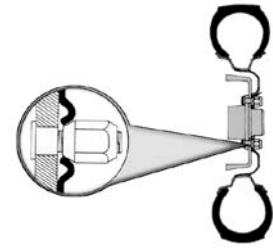

Wheel fixing

Fitting a Wheel When fitting a wheel, the nuts or bolts must be tightened evenly in a diagonal sequence. It is also vital that they are set to the correct torque. Ensure the cone shaped end of the wheel nuts is fitted towards the wheel.



Torque sequences

Wheel Rim Measurement Car wheel rim measurement consists of three main dimensions as shown. The nominal rim diameter is the distance between the bead seats. The inside rim width, is the distance between rims. It is not possible to measure this when the tyre is fitted. The flange height can be determined by subtracting the nominal diameter, from the outside rim diameter.

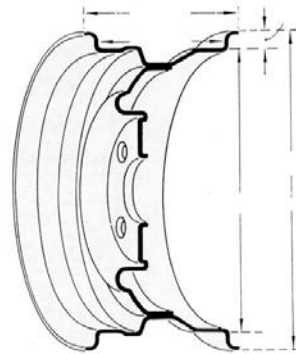

Rim sizes

Types of Rims There are many types of car wheel rims. The picture shows a selection of those in common use. The arrows indicate the side of the rim over which the tyre should be removed or fitted.

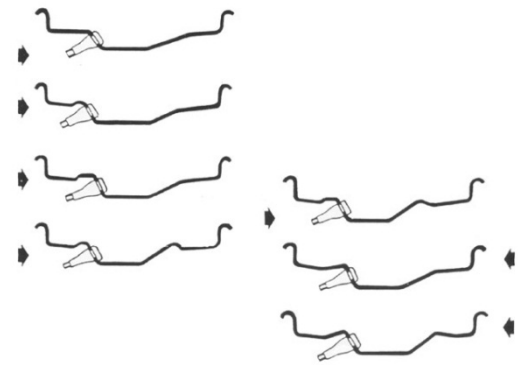

Rims and tyre fitting directions

TR Rim The constant, and welcome, strive for better performance and safety, led to the development of the TR rim profile by Michelin. The TR rim was developed for use with the TRX tyre. This rim provides a better support for the tyre bead leading to improved road holding and steering. The low flange results in a reduced well depth. This allows better air flow round the brakes.



TR rim profile

TD Rim The TD rim was a further development that allows some 'run flat' capability. Conventional rims, which have a well for tyre removal and fitting, also have the disadvantage that the tyre can roll off the rim in the event of a puncture when driving. The TD rim prevents this by the use of two circumferential grooves into which the specially shaped tyre bead fits. If a puncture occurs, the 'run flat' facility is intended to be for bringing the vehicle to a safe stop, not for continued use. Modern versions of this tyre are now in use.



TD rim profile



Modern tyre

Rim and Wheel Markings Markings on the wheel rims are used to indicate the nominal and inside rim diameters. A code letter indicates the flange height, or whether the rim is a TR or TD profile.

Valves The valve is to allow the tyre to be inflated with air under pressure, prevent air from escaping after inflation, and to allow the release of air for adjustment of pressure. The valve assembly is contained in a brass tube, which is bonded into a rubber sleeve and mounting section.

Valve Core The valve core consists of a centre pin, which has metal and rubber disc valves. When the tyre is inflated, the centre pin is depressed, the disc valve moves away from the bottom of the seal tube and allows air to enter the tyre. To release air, or for pressure checking, the centre pin is depressed. During normal operation, the disc valve is held onto its seat by a spring and by the pressure of air. If all the air needs to be released, the valve core assembly can be removed. The upper part of the valve tube is threaded to accept a valve cap. This prevents dirt and grit from entering and acts as a secondary seal.

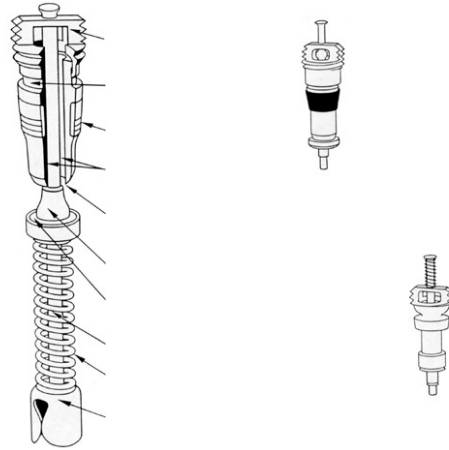

Details of the valve construction

Tubeless Valve The tubeless valve core is as described previously. However, the valve body must be made so that when fitted into the wheel, an airtight seal is formed. Wheel rims used for tubeless tyres must be sealed and airtight. Most wheels and tyres in use are of the tubeless design.

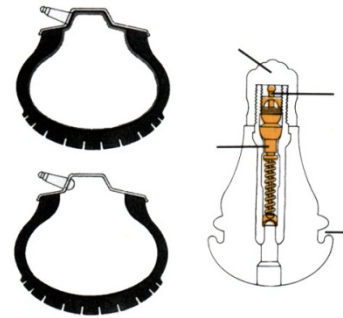

Tyres and valves



Look back over the previous section and write out a list of the key bullet points here:

TYRES INTRODUCTION

Basic Functions The tyre performs two basic functions. It acts as the primary suspension, cushioning the vehicle from the effects of a rough surface. It also provides frictional contact with the road surface. This allows the driving wheels to move the vehicle. The tyres allow the front wheels to steer and the brakes to slow or stop the vehicle.

Pneumatic Tyres The tyre is a flexible casing, which contains air. Tyres are manufactured from reinforced synthetic rubber. The tyre is made from an inner layer of fabric plies, which are wrapped around bead wires at the inner edges. The bead wires hold the tyre in position on the wheel rim. The fabric plies are coated with rubber, which is moulded to form the side walls and the tread of the tyre. Behind the tread is a reinforcing band, usually made of steel, rayon, or glass fibre. Modern tyres are mostly tubeless, so they also have a thin layer of rubber coating the inside to act as a seal.

Radial Tyre Carcass An innermost sheet of airtight synthetic rubber performs the 'inner tube' function. The carcass ply is made up of thin textile fibre cables, laid out in straight lines and bonded into the rubber. These cables are largely responsible for determining the strength of the tyre structure. The carcass ply of a car tyre has about 1,400 cables, each capable of withstanding 15 kg. A lower filler is responsible for transferring propulsion and braking torques, from the wheel rim, to the road surface.

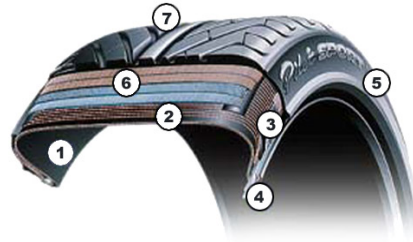

Tyre carcass construction

Radial Tyre Features Beads clamp the tyre firmly against the wheel rim. The beads can withstand forces up to 1,800 kg. The tyre has supple rubber walls, which protect the tyre against impacts (with kerbs, etc.) that might otherwise damage the carcass. There is also a hard rubber link between the tyre and the rim. Crown plies, consist of oblique overlapping layers of rubber reinforced with very thin, but very strong, metal wires. The overlap between these wires, and the carcass cables, forms a series of non-deformable triangles. This arrangement lends great rigidity to the tyre structure.

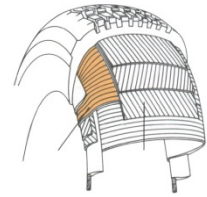

Radial tyre make up

Tyre Markings Markings on the sides of tyres are quite considerable and can be a little confusing. The following is a list of the information given on modern tyres. The size, speed and load headings will be examined in more detail.

Size (E.g. 195/55-15)

Speed Rating (E.g. H, V, Z)

Load Index (E.g. 84, 89, 92,)

UTQG Ratings (Temperature, Traction, Tread wear)

M&S Designation

Maximum Load

Maximum Pressure

Type of Construction

EU approval mark

US approval mark

Manufacture Date

Tyre Sizes A tyre's size is expressed in the format WWW/AA-DD (E.g. 195/55-15).

WWW is the tyre's sidewall-to-sidewall width in millimetres (195). AA is the aspect ratio or profile (55). This gives the tyre's height as a percentage of its width. DD is the diameter of the wheel in inches (15). Some tyres now also give this in millimetres. If the size is shown as P195/55R15, the 'P' stands for passenger and the 'R' is for radial ply construction.



Side of a tyre showing markings

Older Tyres For an older tyre without an aspect ratio (E.g. 195R13), it is assumed to be about an 80 series tyre, (195/80R13). The practice of listing the aspect ratio is now more common. The speed rating was traditionally shown as a part of the tyre's size, (E.g. 195/55VR15). Since the inclusion of load ratings, many manufacturers now show the speed rating after the size in combination with the load rating, (E.g. 195/55R15 84V).



Side of a tyre showing markings

Speed Ratings Commonly used speed ratings are shown in this table.

- Rating
- Certified Maximum Speed (km/h)
- Certified Maximum Speed (mph)

<u>1</u>	<u>2</u>	<u>3</u>
N	140	88
Q	160	100
S	180	112
T	190	118
U	200	124
H	210	130
V	240	150*
Z	over 240	over 150
W	270	169
Y	300	188

* Note that originally, V was 'over 130mph'. As W and Y ratings are now used, Z is redundant.

Load Index The load index indicates the maximum weight the tyre can carry at the maximum speed indicated by its speed rating. Some 'Load Rating Indices' are listed in this table.

Rating - Capacity (kg) - Capacity (lb.)

75	387	853
82	475	1 047
84	500	1 102
85	515	1 135
87	545	1 201
88	560	1 235
91	615	1 356
92	630	1 389
93	650	1 433
105	925	2 039

Performance Tyre Tread The type of tyre tread shown here uses a directional pattern for improved water evacuation. The centre rib gives improved steering control. Overall, this tyre, manufactured by Avon, gives improved wet grip and reduced noise.



Directional pattern tread

Standard Tyre Tread This tyre is built for the cost conscious motorist. It saves fuel when fitted all round because of a lower rolling resistance. The rubber compound used, prolongs tyre life. It has been made using environmentally neutral methods.



Avon 'cost conscious' tyre

4x4 Tyre Tread Most 4x4 vehicles use tyres with a 'block' type of tread pattern. This gives the mix of performance required for road, and off road, use. These tyres are sometimes described as 'mud and snow'.

Racing Tyres The rubber compound of a tyre provides grip - not the tread. However, without the tread to disperse water, very little grip can be achieved. Formula 1, and other racing tyres, were at one time used without tread. These were known as 'slicks'. Nowadays, these high performance tyres have some grooves to disperse water!



F1 tyres in action for Jaguar at Silverstone



Look back over the previous section and write out a list of the key bullet points here:

WHEEL BALANCING

Introduction ☐☐☐ Correctly balanced wheels is an important comfort and safety issue. An out of balance wheel produces vibration and a reduction in steering control. It will also result in abnormal tyre wear. However, the wheel and tyre are not always to blame. Worn steering joints, wheel bearings or driveshaft joints can also cause vibration.

Balance A wheel and tyre may be out of balance either statically or dynamically. Static balance relates to a stationary wheel. Dynamic balance relates to the conditions of a rotating wheel.



Wheel with an out of balance mass

Static Balance A wheel and tyre that is in perfect static balance has the mass evenly distributed around its centre. When mounted on a free bearing and spun, it comes to rest in any position.

Static Imbalance ☐☐☐☐ A simple example of static imbalance is a bike wheel. When spun freely, it will always come to rest with the valve at the bottom. The effect of static imbalance on a vehicle is to cause it to 'tramp' up and down. The effect becomes progressively worse at higher speeds. This puts a strain on the steering and suspension components.

Curing Static Imbalance To cure static imbalance a compensating mass or masses, are placed on the wheel. One method is to place a large mass on the wheel flange. Another is to use two smaller masses as shown. These methods are used because it is not normally possible to put an extra mass on the wheel centre line.



Wheels that have been statically balanced

Dynamic Balance The term 'dynamic' is used because the effect is only noticeable when the wheel is in motion. This is felt, when driving, as a 'steering wobble'. It can be dangerous if excessive, and at the least, it results in premature tyre wear.

Dynamic Imbalance Dynamic imbalance is best explained by imagining a crank, like the pedals of a bike, as shown here. If the weights are equal, and at the same distance from the bearing centre line, it will be statically balanced. However, when the crank rotates a force will act on each weight in an outwards direction. This will result in a twisting force on the bearing, which is described as a 'couple'. The direction of the 'couple' reverses every half turn, resulting in a rocking movement of the vehicle steering. The force increases with speed.

Car Wheel Dynamic Imbalance The wheel shown here has been statically balanced. Mass B has been added to compensate for the out of balance mass A. However, because the masses A and B are not in the same plane, a twist or couple will be set up. This will result in a dynamic imbalance.



Statically balanced but dynamically imbalanced

Curing Dynamic Imbalance The out of balance wheel in the first picture, can be balanced in three ways as shown. Adding a weight on the centre line is fine, but this can only be done on spoked wheels. Weight on one flange will only statically balance the wheel. Smaller weights on both flanges will result in a statically, and dynamically, balanced wheel.

Curing Static and Dynamic Imbalance

In reality, an out of balance mass is usually away from the wheel centre line. Static and dynamic imbalance occurs. To compensate for this, weights are added as indicated by a balancing machine. The weights may not be directly opposite the out of balance mass.



Weights A and B cure the imbalance due to M

Wheel Balancing Machine  When a balancing machine is operated, the wheel is spun at high speed. An indication is given to the users, of the required masses and their positions, on the wheel. Do not use this type of equipment unless you have been trained.

Balance Weights Small lead weights are used for rectifying out of balance wheels. The weights either clip onto the rim of steel wheels, or bond with adhesive, to the rim of alloy wheels.



Lead weights

Summary Correct wheel and tyre balance is essential for safe operation of the vehicle. Excessive tyre wear results from imbalance. A wheel must be balanced statically and dynamically. Modern wheel balancers will achieve both these requirements quickly and easily.



Look back over the previous section and write out a list of the key bullet points here:

Introduction The abbreviation R&R is short for remove and refit components, or remove and reassemble components. Wheels and tyres will usually be removed, inspected and repaired or replaced when a defect has been diagnosed. Other components are replaced, or stripped and cleaned, at scheduled mileage or time intervals. Refer to the Routine Maintenance Section for details on these items.

Recommended Procedures The descriptions provided in this section deal with the components for individual replacement, rather than as a part of other work. Always refer to a workshop manual before starting work. You will also need to look for the recommended procedure, special tools, materials, tightening sequences and torque settings. Some of the common tools and pieces of equipment are described on the following screens.

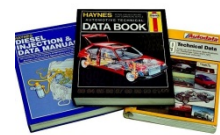

Refer to data as required

Torque Wrench A good torque wrench is an essential piece of equipment. Many types are available but all work on a similar principle. Most are set by adjusting a screwed cylinder, which forms part of the handle. An important point to remember is that, as with any measuring tool, regular calibration is essential to ensure it remains accurate.



A torque wrench is a useful tool

Air Guns The whole point of power tools is that they do the work so you don't have to! Most air guns have an aluminium housing. This material is light weight but gives long life. Air guns produce a 'hammer' action. Because of this, impact sockets should be used. Normal sockets can shatter under this load. It is important to remember that air tools need lubricating from time to time.



Air guns get the job done fast

Wheel Balancer Most wheel balancers offer facilities for measuring the wheel, and then programming this into a computer. The machines usually run from a mains electrical supply. The wheel is clamped to the machine and spun. Sensors in the machine determine the static and dynamic balance. A display states where extra weights should be added to obtain accurate balance. 'On-car' balancers have been used, but are less accurate than the later computerised types.



Balancer

Jacks and Stands Most jacks are simple hydraulic devices. Remember to make sure the safe working load (SWL) is not exceeded. Ensure that any faults with equipment such as this are reported immediately. Axle stands must always be placed under the vehicle supporting the weight - before work is carried out.



Always use stands...



After jacking a vehicle

Ramps and Hoists The hoist shown here is semi portable and is ideal for use in smaller workshops. Many ramps are available ranging from large four-post wheel-free types to smaller single-post lifts. These large items should be inspected regularly to ensure they are safe.



Portable hoist

Tyre Changer It is possible to change tyres with two levers and a hammer! However, it is much quicker and easier with an automatic changer. A lever is still needed to start the bead of the tyre lifting over the rim. An electric motor drives the wheel round as the tyre is removed or fitted. Most changers incorporate a bead breaker.



Many types of changer are available

Tyre Inflators This is a simple but important item of equipment. Make sure it is looked after so that the gauge remains accurate. A small difference in tyre pressure can have a significant effect on performance and wear.



The gauge must be accurate



Look back over the previous section and write out a list of the key bullet points here:

ROUTINE MAINTENANCE

Scheduled Servicing Scheduled service requirements for wheels and tyres are quite simple. The wheels should be checked for damage. The tyres should have their pressures set accurately. They should also be checked for tread condition and damage.



Wheels and tyres

Tyre Inflation Pressures  The pressure at which the tyres perform best is determined by a number of factors:

- Load to be carried
- Operating speed
- Number of plies
- Operating conditions
- Section of the tyre.

Manufacturer's Recommended Settings Tyre pressures must always be set at the manufacturer's recommended values. Pressure will vary according to the temperature of the tyre - this is affected by operating conditions. Tyre pressures should always be adjusted when the tyre is cold and be checked at regular intervals.



Tyre pressure wall chart

Tread Depth Checks Check that the tread depth, at all points round the tyre, meets current regulations. Many tyres have 'wear indicators' cast into the tread pattern.



Tread wear indicator

Data Sources Many good data books are available that list recommended pressures. Wall charts are also used by workshops. The figures are also listed in the owner's handbook.

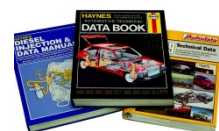

Data books



Worksheet Check wheels and tyres for signs of

damage and set tyre pressures.

This task should be carried out at all service intervals. Some faults require immediate attention and some should be reported to the customer. For example, a bald tyre needs replacing, but a tyre that is becoming worn should be reported.

Damaged Wheels Some wheel faults can cause slow deflation of the tyre. Alloy wheels with signs of cracking should be replaced immediately. A damaged steel wheel may affect handling.



Damaged wheel



A flat tyre!

Tyre Damage Tyres are clearly an important safety issue. Check carefully all round the tyre, inside and out. Look for tread wear and damage to the sidewalls. Feel the pattern of the tyre from left to right, and right to left, to check for signs of feathering. This is usually caused by incorrect tracking.

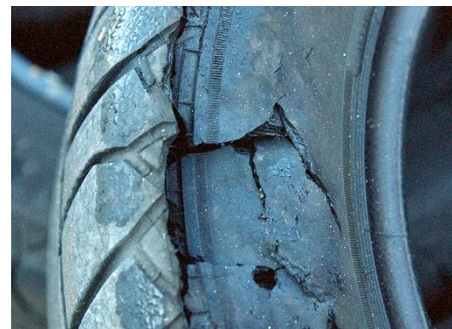

Damaged tyre

Valves Check valves for signs of leakage and make sure the dust cap is fitted. The cap not only prevents dust entering the valve, it is also a secondary air seal.



Tubeless tyre valve

Summary Safety of all road users and pedestrians is essential. The condition of a vehicle's wheels and in particular the tyres is therefore vital. Carry out a check at all service intervals.



Look back over the previous section and write out a list of the key bullet points here:

WHEELS AND TYRES - CUSTOMER CARE

Regular Checks Regular checks are vital for a customer's safety. Carry these out at all services and report your findings to the customer. Advise customers if the tyres will need attention before the next scheduled service interval.

Long Journeys  If a customer uses the vehicle for many long journeys, they should be advised to check the tyre treads and pressures regularly. Tyre pressures can have a significant effect on vehicle handling.

High Speed Use Manufacturers may have different tyre pressure settings for a vehicle that is used at high speeds. Talk to the customer and advise them of this if necessary.

Spare Wheel and Tyre The spare wheel and tyre are often overlooked on a service. Make sure you check the condition and pressure. Report any faults to the customer. Some manufacturers recommend that the pressure of a spare tyre is kept slightly higher than normal. Show the customer how to access and remove the wheel if necessary.

Driving Style  Driving style can have a significant effect on the life and condition of a tyre. Driving the car over kerbs, for example, can damage the tyre and the wheel. High speed cornering can accelerate tyre wear. Wheel spins can have a similar effect.

Tread Patterns Tread patterns vary, depending on the main use intended for the tyre. Advise the customer of this as required. A car fitted with mud and snow tyres, for example, would perform well in soft conditions. However, it is likely to produce tyre noise on the road under normal conditions.

Summary A customer who is kept informed and treated with respect will return and keep you in a job! Explain things to a customer when asked - it will be appreciated.

TRANSMISSION SYSTEMS

MANUAL TRANSMISSION CLUTCH

TRANSMISSION SYSTEM OVERVIEW

Introduction Transmission is a general term used to describe all the components required to transmit power from the engine to the wheels. The requirement is to convert the power from the relatively high velocity and low torque of the engine crankshaft, to the variable, usually lower speed and higher torque, needed at the wheels.

Types of Transmission The two basic types of transmission use either a manual gearbox, in which the gears are selected by the driver, or an automatic gearbox, in which the gears are changed automatically.



Manual
transmission



Automatic
transmission

Front Wheel Drive Transmission

Working from the engine to the wheels, the main components of a typical front wheel drive transmission system, are as follows:

- Clutch
- Gearbox
- Final drive
- Differential
- Drive shafts.

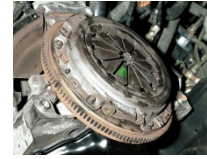

Clutch

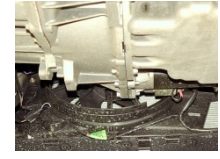

Gearbox



Final drive and differential



Driveshaft

Rear Wheel Drive Transmission

Working from the engine to the wheels, the main components of a typical rear wheel drive transmission system, are as follows:

- Clutch
- Gearbox
- Propshaft
- Final drive
- Differential
- Half shafts.

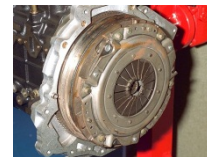

Clutch



Gearbox

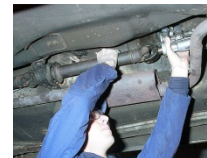

Propshaft



Final drive and differential

Clutch Fitted between the engine and gearbox the clutch allows the drive to be disconnected when the pedal is depressed. It allows a smooth take up of drive and allows gears to be changed.

Manual Gearbox □□□ A manual gearbox is a box full of gears of varying ratios! The ratio most suitable for the current driving conditions can be selected by the gear stick. Most boxes contain about thirteen gear cogs, which allow five forward gears and one reverse.

Torque Converter A torque converter is sometimes called a fluid flywheel (although the two differ slightly) and is used in conjunction with an automatic gearbox. It is in two main parts. As the input section rotates, fluid pressure begins to act on the output section, which is made to rotate. As speed increases, a better drive is made. The drive therefore takes up automatically and smoothly.

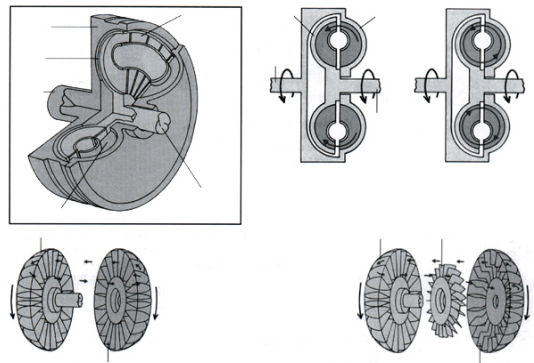

Automatic Gearbox As the name suggests this is a gearbox, which operates automatically. Most types contain special gear arrangements, known as epicyclic gear trains. Some now use very complicated electronic control, but the basic principle is that fluid pressure from a pump, which changes with road speed, is used to change the gears.



Epicyclic gears are often used in an 'auto-box'

Final Drive To produce the required torque at the road wheels, a fixed gear reduction from the high engine speed is required. The final drive consists of just two gears with a ratio of about 4:1. These are bevel gears on rear wheel drive systems and normal gears on front wheel drive.

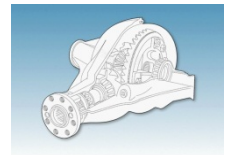

Differential and final drive combination

Differential A special combination of gears, which allows the driven wheels of a vehicle to rotate at different speeds. Think of a car going round a roundabout, the outer wheel has to travel a greater distance, and hence must rotate at a faster speed than the inner wheel. If this was not allowed for the drive would 'wind-up' and something would break.



The differential can be called a torque equaliser

Driveshafts Two driveshafts are used to pass the drive from the outputs of the final drive, to each wheel. Each driveshaft contains two constant velocity joints. These joints are covered with a rubber boot to keep out water and dirt.



This shaft transmits drive to the wheels

Propshaft On rear wheel drive vehicles, the drive has to be passed from the gearbox output, to the final drive and differential unit, in the rear axle. The propshaft, short for propeller shaft, is a hollow tube with a universal joint at each end. If removed the universal joints must be aligned correctly.



This shaft transmits drive to the final drive

Universal Joint The UJ is like a cross with a bearing on each leg. It allows drive to be transmitted through an angle. This is to allow for suspension movement.



This is called a UJ

Constant Velocity Joint □□□ The constant velocity joint is a bit like a UJ. It is used on front wheel drive, driveshafts. It allows a smooth, constant velocity drive, to be passed through, even when the suspension moves up and down and the steering moves side to side.

Summary The clutch is a key component in the transmission system. However, it works in conjunction with other parts. All should be operating correctly for optimum performance.

 Explain the purpose of a propshaft.

 Look back over the previous section and write out a list of the key bullet points here:

PURPOSE OF THE CLUTCH COMPONENTS

Purpose of the Clutch  A clutch is a device for disconnecting and connecting rotating shafts. In a vehicle with a manual gearbox, the driver depresses the clutch when changing gear, thus disconnecting the engine from the gearbox. It allows a temporary neutral position for gear changes and also a gradual way of taking up drive from rest.

Automatic Transmission Cars with automatic transmission do not have a clutch as described here. Drive is transmitted from the flywheel to the automatic gearbox by a torque converter, sometimes called a fluid clutch.



Torque converter components

Gearbox For most light vehicles, a gearbox has five forward gears and one reverse gear. It is used to allow operation of the vehicle through a suitable range of speeds and torque. A manual gearbox needs a clutch to disconnect the engine crankshaft from the gearbox while changing gears. The driver changes gears by moving a gear lever, which is connected to the box by a mechanical linkage.

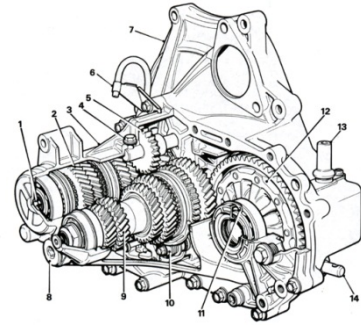

Clutch Components Each of the following screens covers one or more typical clutch components. Some are more important than others. The driven plate and the pressure plate are the two main parts.



Driven plate and pressure plate

Reluctor Ring In conjunction with a sensor, the reluctor ring provides a signal for the ignition and fuel systems. It supplies information on engine speed and position. However, it is not part of the clutch!

Flywheel The flywheel keeps the engine running smoothly between power strokes. It also acts as a surface against which the driven plate can press. A locking plate is used for security of the flywheel.

Driven Plate □□□ The driven plate is a friction material plate, which is clamped between the pressure plate and the flywheel. It is splined on to the gearbox input shaft. The small coil springs are to prevent the clutch snatching as drive is taken up.

Pressure Plate □□□ This cover of the pressure plate is fixed to the flywheel with a ring of bolts. The fingers in the centre act as springs and levers to release the pressure. Drive is transmitted unless the fingers are pressed in towards the flywheel.

Release Bearing □□□ A release shaft transfers the movement of the cable to the release fork and bearing. The bearing pushes against the clutch fingers when the pedal is depressed, to release the drive. A return spring is used so that when the clutch pedal is not depressed, the bearing allows the clutch fingers to return outwards. A seal is fitted to keep out water and dirt.

Clutch Cable □□□ The clutch cable makes a secure connection to the clutch pedal. Strong steel wire is used. Movement of the pedal is therefore, transferred to the release bearing. A few vehicles use hydraulics to operate the clutch.

Cable Seating Plate and Pad □□□ A support is made for the ball end of the cable. Many different methods are used and this is just one example. The rubber pad prevents metal-to-metal contact. A retaining clip secures the end of the cable.

Bell Housing □□□ A general cover is used for the clutch assembly but it is also the way to secure the clutch and gearbox to the engine. Some front wheel drive clutches are covered with a thin pressed steel plate.

Summary □□□ The clutch is a device for disconnecting and connecting drive from the engine. It allows a temporary neutral position for gear changes and a gradual way of taking up drive from rest.



State the purpose of a release bearing.



Look back over the previous section and write out a list of the key bullet points here:

CLUTCH OPERATING MECHANISMS

Introduction □□□ The driver operates the clutch by pushing down a pedal. This movement has to be transferred to the release mechanism. There are two main methods used. These are cable and hydraulic. The cable method is the most common. Developments are taking place and an electrically operated clutch will soon be readily available.

Cable A steel cable is used, which runs inside a plastic coated steel tube. The cable 'outer' must be fixed at each end. The cable 'inner' transfers the movement. One problem with cable clutches is that movement of the engine, with respect to the vehicle body, can cause the length to change. This results in a judder when the clutch is used. This problem has been almost eliminated however, by careful positioning and quality engine mountings.

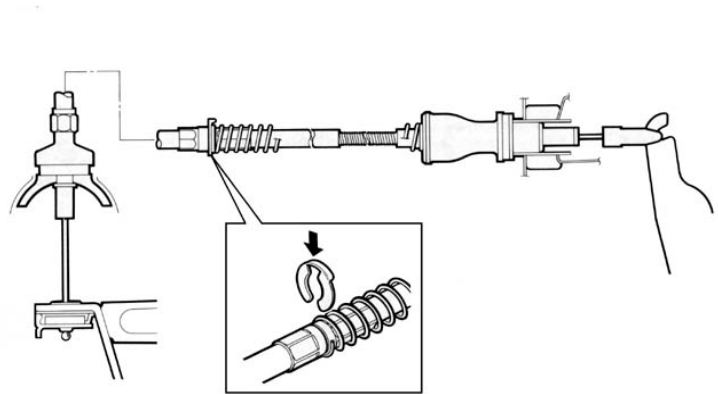

Clutch cable

Cable Operation This clutch cable works on a simple lever principle. The clutch pedal is the first lever. Movement is transferred from the pedal to the second lever, which is the release fork. The fork in turn, moves the release bearing to operate the clutch.

Hydraulic A hydraulic mechanism involves two cylinders. These are termed the master and slave cylinders. The master cylinder is connected to the clutch pedal. The slave cylinder is connected to the release lever.

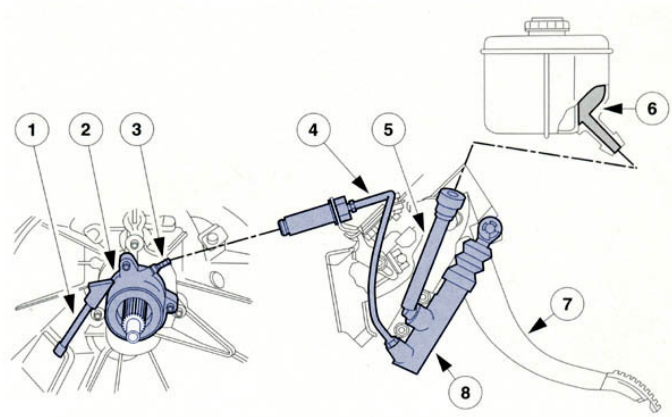

Clutch hydraulic components

Hydraulic Operation □□□ The clutch pedal moves the master cylinder piston. This pushes fluid through a pipe, which in turn forces a piston out of the slave cylinder. The movement ratio can be set by the cylinder diameters and the lever ratios.

Electronic Clutch

The electronic clutch was developed for racing vehicles to improve the getaway performance. For production vehicles, a strategy has been developed to interpret the driver's intention. With greater throttle openings, the strategy changes to prevent abuse and drive line damage. Electrical control of the clutch release bearing position is by a solenoid actuator, which can be modulated by signals from the

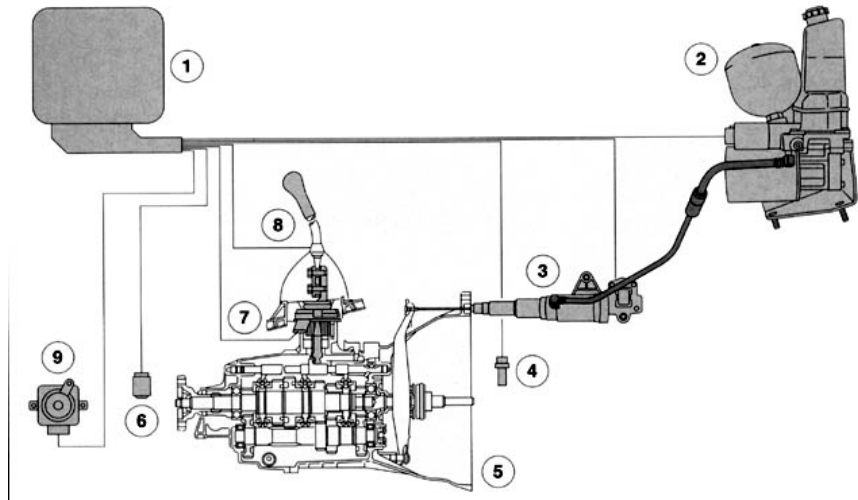

ECU. This allows the time to reach



Describe a hydraulic clutch mechanism.



Look back over the previous section and write out a list of the key bullet points here:

TOOLS AND EQUIPMENT

Introduction The abbreviation R&R is short for remove and refit components, or remove and reassemble components. Components will usually be removed, inspected and repaired or replaced when a defect has been diagnosed. Other components are replaced, or stripped and cleaned, at scheduled mileage or time intervals. Refer to the Routine Maintenance section for details on these items.

Recommended Procedures The descriptions provided in this section deal with the components for individual replacement, rather than as a part of other work. Always refer to a workshop manual before starting work. You will also need to look for the recommended procedure, special tools, materials, tightening sequences and torque settings. Some of the common tools and pieces of equipment are described on the following screens.

Torque Wrench A good torque wrench is an essential piece of equipment. Many types are available but all work on a similar principle. Most are set by adjusting a screwed cylinder, which forms part of the handle. An important point to remember is that, as with any measuring tool, regular calibration is essential to ensure it remains accurate.



A torque wrench is a useful tool

Air Guns □□□ The whole point of power tools is that they do the work so you don't have to! Most air guns have an aluminium housing. This material is light weight but gives long life. Air guns produce a 'hammer' action. Because of this, impact sockets should be used. Normal sockets can shatter under this load. It is important to remember that air tools need lubricating from time to time.

Jacks and Stands Most jacks are simple hydraulic devices. Remember to make sure the safe working load (SWL) is not exceeded. Ensure that any faults with equipment such as this are reported immediately. Axle stands must always be placed under the vehicle supporting the weight - before work is carried out.



Always use stands...



After jacking a vehicle

Ramps and Hoists Many ramps are available ranging from large four-post wheel-free types to smaller single-post lifts. These large items should be inspected regularly to ensure they are safe.



Twin post lift

Transmission Jack If a complete gearbox has to be removed, it is likely to be heavy! A transmission jack has attachments that allow you to support the gearbox and lower it safely. The equipment is hydraulically operated just like an ordinary jack. Often, the height can be set by using a foot pedal, which leaves both hands free for positioning the unit.



This jack will support a gearbox

Clutch Aligner Kit The clutch disc must be aligned with the cover and flywheel when it is fitted. If not, it is almost impossible, on some vehicles to replace the gearbox. This is because the gearbox shaft has to fit through the disc and into the pilot or spigot bearing in the flywheel. The kit shown here has adaptors to suit most vehicles.



The clutch must be aligned when fitted

Pilot/Spigot Bearing Puller Removing spigot bearings is difficult without a proper puller. This tool has small legs and feet that hook under the bearing. A threaded section is tightened to pull out the bearing.



An internal bearing puller

Air Ratchet These tools are very useful for removing or fitting nuts and bolts. However, it is possible to over tighten if care is not taken. Air tools can be very powerful and will trap your hands! Take adequate precautions at all times.



These tools are very useful



Look back over the previous section and write out a list of the key bullet points here:

ROUTINE MAINTENANCE

Scheduled Servicing Scheduled service requirements for the clutch are quite simple. The clutch should be checked for correct operation and the adjustment set if required. The clutch pedal should be secure and operate correctly.

Non-Routine Work When carrying out routine maintenance, some non-routine work may be found. This should be reported to the driver or owner of the vehicle before repairs are carried out.

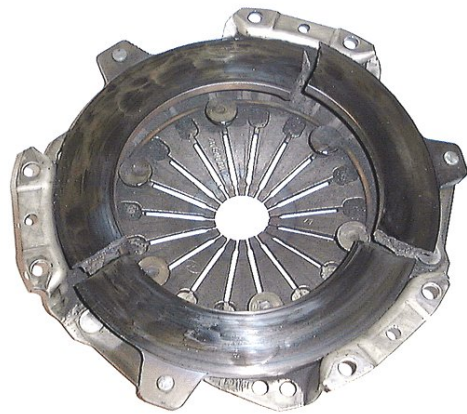

Seriously damaged clutch!



Worksheet Check and adjust clutch freeplay.

The freeplay on a clutch is to ensure that it will always fully engage. Initial symptoms of a problem include a slipping clutch, if not enough freeplay, or difficult gear changing, if too much. Check manufacturer's data for the correct setting.

Pedal Height Pedal height is usually altered by adjusting a stop bolt. This is located on the pedal box in the driver's foot well. Check manufacturer's data for the correct setting.

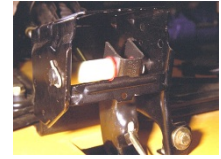

Pedal box

Cable Components The cable and automatic adjustment mechanism should be visually inspected for signs of wear or damage. A cable that is fraying should be replaced. Some automatic adjusters have teeth, which can wear out after prolonged use.



Clutch cable

Hydraulic Components Visually inspect all hydraulic components. Look for signs of fluid leaking from the master cylinder, pipes and slave cylinder. Repair any faults found. Top up the reservoir if required.



Slave cylinder

Clutch Adjustment Checking clutch freeplay is easier with an assistant. Check carefully how far the pedal moves before the clutch lever moves. Adjust to recommended settings where possible.



Checking the clutch lever

Automatic Adjuster Automatic adjusters do not often need attention. However, repair or replace the automatic adjuster if freeplay is incorrect. There are two main types; one uses a ratchet pawl and the other works with a sleeve on the cable.

Bleeding the Hydraulics Hydraulic systems may need some extra work. If the feel of the clutch pedal becomes 'spongy', it may be necessary to bleed air out of the system. This is done by connecting a rubber tube to a bleed nipple on the slave cylinder. The other end of the tube is placed in a container holding a small amount of fluid. The clutch pedal is pumped slowly until all the air is expelled. Remember to keep the reservoir topped up during this process.



Pipe connected to the slave cylinder

Topping Up Always use the fluid recommended by the manufacturer. Take particular care not to spill fluid, as it will damage paintwork. The same type of hydraulic fluid is usually used for the clutch and the brake systems.



Hydraulic fluid



Clutch reservoir

Summary Safety of all road users and pedestrians is essential. Reliable operation of the vehicle is also important. The condition of the clutch is therefore vital. Carry out a check at all service intervals.



Look back over the previous section and write out a list of the key bullet points here:

CLUTCH - CUSTOMER CARE

Driving Style □□□ Driving style can have a significant effect on the life and condition of a clutch. Customers, of course, are entitled to drive how they wish! However, it may be appropriate to offer tactful advice if a clutch, or driveline component, breaks unexpectedly. Rapid starts, for example, can cause damage to a number of components.

Slipping the Clutch Holding a car with the clutch slipping, on a hill at traffic lights for example, increases the wear rate. It may again be appropriate to offer tactful advice if a clutch wears out before its expected life. Do take care not to insult!

Clutch Feel □□□ Tell your customers to report any changes in the 'feel' of the clutch pedal. If it becomes stiff or a noise is noticed for example. This may be an early warning sign of a problem and an inconvenient breakdown could be avoided.

Vehicle Condition Respect your customer's vehicle and take precautions to keep it clean. Repairing or checking the clutch, is

likely to involve you working under the vehicle, and then sitting in the driver's seat. Use seat covers and ensure the steering wheel is cleaned when you have finished.

MANUAL TRANSMISSION GEARBOX

GEARBOX OPERATION

Introduction □□□ A transmission system gearbox is required because the power of an engine consists of speed and torque. Torque is the twisting force of the engine's crankshaft and speed refers to its rate of rotation. The transmission can adjust the proportions of torque and speed that is delivered from the engine to the drive shafts. When torque is increased, speed decreases and when speed is increased, the torque decreases. The transmission also reverses the drive and provides a neutral position when required.

Types of Gear Helical gears are used for almost all modern gearboxes. They run more smoothly and are quieter in operation. Earlier 'sliding mesh' gearboxes used straight cut gears, as these were easier to manufacture.

Helical gears do produce some sideways force when operating, but this is dealt with by using thrust bearings.

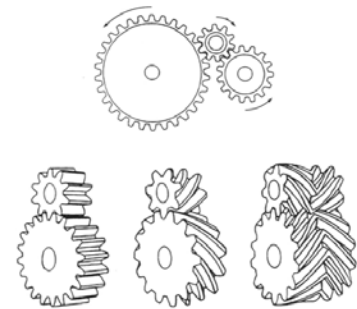

Straight cut and helical gears

Gearbox For most light vehicles, a gearbox has five forward gears and one reverse gear. It is used to allow operation of the vehicle through a suitable range of speeds and torque. A manual gearbox needs a clutch to disconnect the engine crankshaft from the gearbox while changing gears. The driver changes gears by moving a lever, which is connected to the box by a mechanical linkage.



Modern Ford gearbox

Power, Speed and Torque The gearbox converts the engine power by a system of gears, providing different ratios between the engine and the wheels. When the vehicle is moving off from rest, the gearbox is placed in first, or low gear. This produces a high torque but low wheel speed. As the car speeds up, the next higher gear is selected. With each higher gear, the output turns faster but with less torque.



Pontiac six-speed gear selector

Top Gears Fourth gear on most rear wheel drive light vehicles is called direct drive, because there is no gear reduction in the gearbox. In other words, the gear ratio is 1:1 The output of the gearbox turns at the same speed as the crankshaft. For front wheel drive vehicles, the ratio can be 1:1 or slightly different. Most modern light vehicles now have a fifth gear. This can be thought of as a kind of overdrive because the output always turns faster than the engine crankshaft.

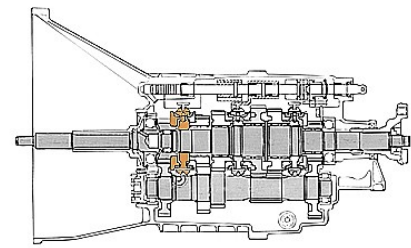

Fourth gear is often 'straight through'

Gearbox Input Power travels in to the gearbox via the input shaft. A gear at the end of this shaft drives a gear on another shaft called the countershaft or layshaft. A number of gears of various sizes are mounted on the layshaft. These gears drive other gears on a third motion shaft also known as the output shaft.

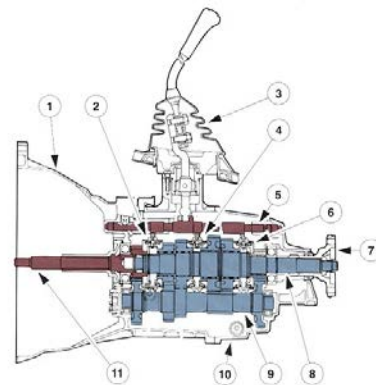

Sectioned view of a gearbox

Sliding Mesh □□ Older vehicles used sliding-mesh gearboxes. With these gearboxes, the cogs moved in and out of contact with each other. Gear changing was, therefore, a skill that took time to master! These have now been replaced by constant mesh gearboxes.

Constant Mesh The modern gearbox still produces various gear ratios by engaging different combinations of gears. However, the gears are constantly in mesh. For reverse, an extra gear called an idler operates between the countershaft and the output shaft. It turns the output shaft in the opposite direction to the input shaft.

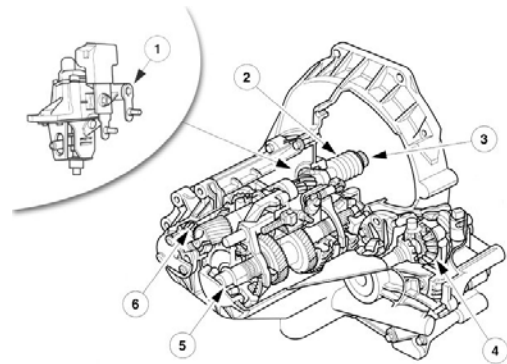

FWD gearbox (transaxle)

Power Flow (RWD) □□ Note how in each case, with the exception of reverse, the gears do not move. This is why this type of gearbox has become known as constant mesh. In other words the gears are running in mesh with each other at all times. □

Power Flow (FWD) □□□ In constant mesh boxes, dog clutches are used to select which gears will be locked to the output shaft. These clutches, which are moved by selector levers, incorporate synchromesh mechanisms. □

Summary □□□ A manual gearbox allows the driver to select the gear appropriate to the driving conditions. Low gears produce low speed but high torque; high gears produce higher speed but lower torque.



Look back over the previous section and write out a list of the key bullet points here:

GEAR CHANGE MECHANISMS

Introduction □□□ On all modern gearboxes, the selection of different ratios is achieved by locking gears to the mainshaft. A synchromesh and clutch mechanism does this when moved by a selector fork. The selector fork is moved by a rod, or rail, which in turn is moved by the external mechanism and the gearstick.

Single Rail System To save space, some manufacturers use a single selector shaft. This means the shaft has to twist and move lengthways. The twisting allows a finger to contact with different selector forks. The lengthways movement pushed the synchronisers into position. All the selector forks are fitted on the same shaft.

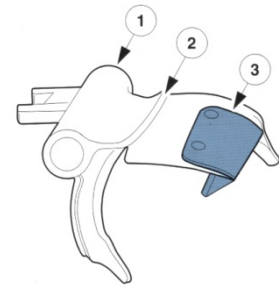

Gear shift or selector fork

Two Rail System On a two-shaft system, the main selector shaft often operates the first/second gear selector fork. An auxiliary shaft operates the third/fourth selector fork.

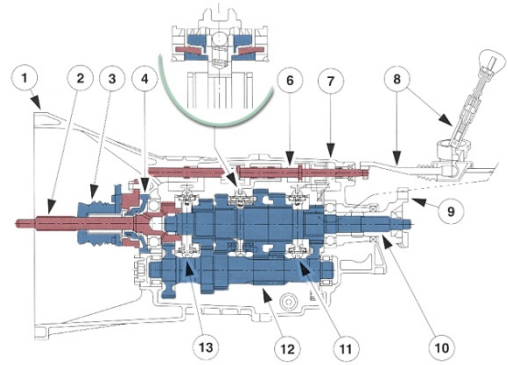

Double selector shaft

Three Rail System The three-rail, or three-shaft system, is similar to the two-shaft type. However, each shaft can be moved lengthways. In turn, the shafts will move the first/second, third/fourth or fifth/reverse forks.

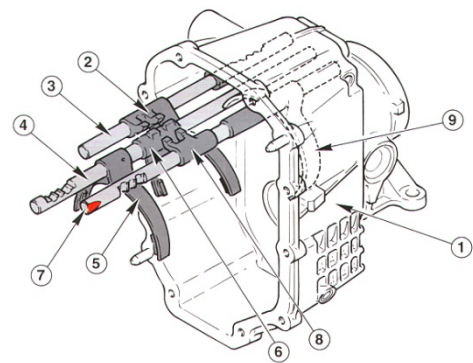

Triple selector shaft

External Linkages A common external linkage is shown here. Movement of the shift lever is transferred to the gearbox by a shift rod. The rod will only move to select reverse gear when the lock sleeve is lifted. This prevents accidental selection of reverse gear.

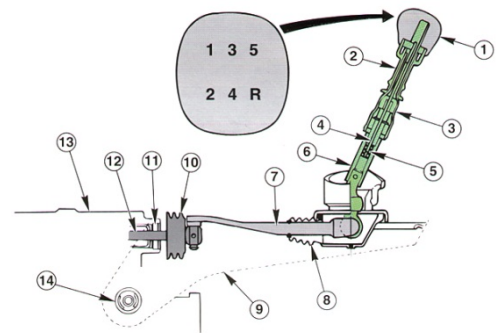

Rod operated shift mechanism

Cable System A recent development is the cable shift mechanism. The advantage of this system is that the shift lever does not have to be fixed to the gearbox or in a set position. This allows designers more freedom.

Detent Mechanism A detent mechanism is used to hold the selected gear in mesh. In most cases, this is just a simple ball and spring acting on the selector shaft(s). Shown here is a gearbox with the detent mechanisms highlighted.

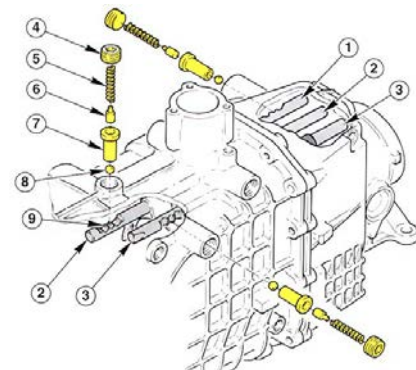

Ball and spring detent

Interlocks Gear selection interlocks are a vital part of a gearbox. They prevent more than one gear from being engaged at any one time. When any selector clutch is in mesh, the interlock will not allow the remaining selectors to change position. As the main selector shaft is turned by side-to-side movement of the gear stick, the gate restricts the movement. The locking plate, shown as number 15, will only allow one shaft to be moved at a time. Because the gate restricts the movement, selection of more than one gear is prevented.

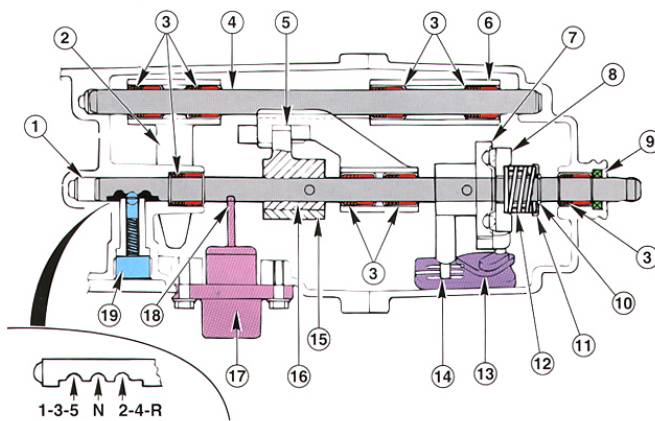

Gearshift mechanism

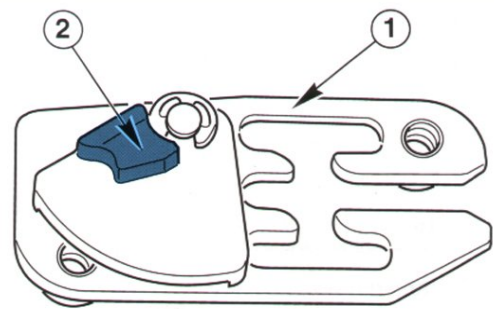

Gate and reverse gear lock

Sliding Plunger Interlock When three rails are used to select the gears, plungers or locking pins can be used. These lock the two remaining rails when one has moved. In the neutral position, each of the rails is free to move. When one rail (rod or shaft) has moved, the pins move into the locking notch, preventing the other rails from moving.

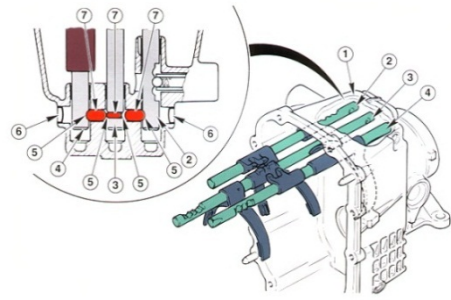

Plunger type interlock

Summary Gear selection must be a simple process for the driver. In order to facilitate changing, a number of mechanical components are needed. The external shift mechanism must transfer movement to the internal components. The internal mechanism must only allow selection of one gear at a time by use of an interlock. A detent system helps to hold the selected gear in place.

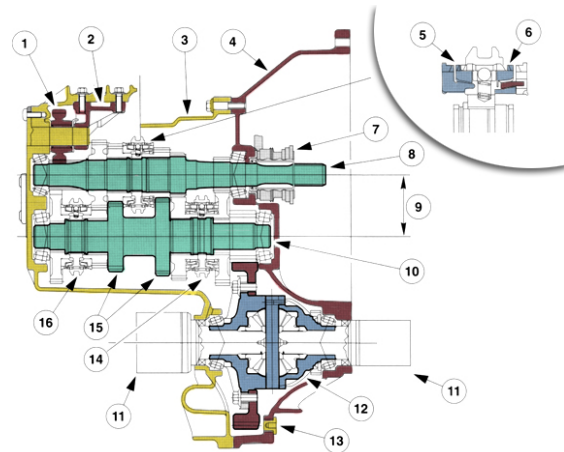

Design features of a transaxle



Look back over the previous section and write out a list of the key bullet points here:

TOOLS AND EQUIPMENT

Introduction Components will usually be removed, inspected and repaired or replaced when a defect has been diagnosed. Other components are replaced, or stripped and cleaned, at scheduled mileage or time intervals. Refer to the Routine Maintenance section for details on these items.

Recommended Procedures The descriptions provided in this section deal with the components for individual replacement, rather than as a part of other work. Always refer to a workshop manual before starting work. You will also need to look for the recommended procedure, special tools, materials, tightening sequences and torque settings. Some general and specific tools and pieces of equipment are described on the following screens.

General Toolkit General tools and equipment will be required for most tasks. As your career develops you will build a collection of tools and equipment. Look after your tools and they will look after you!



Snap-on tools

Soft Hammers These tools allow a hard blow without causing damage. They are ideal for working on gearboxes. Some types are made of special hard plastics whereas some are described as copper/hide mallets. This type has a copper insert on one side and a hide or leather insert on the other. It is still possible to cause damage however, so you must still take care!



Soft hammers

Support Bars When removing gearboxes from some vehicles, it is necessary to support the engine. This is because the engine and gearbox, on front wheel drive vehicles in particular, share the same mountings. Most support equipment is a simple steel frame that fits across two support points such as suspension mounts. A chain or cable is connected to the engine and its tension adjusted.



Engine support equipment

Jacks and Stands Most jacks are simple hydraulic devices. Remember to make sure the safe working load (SWL) is not exceeded. Ensure that any faults with equipment such as this are reported immediately. Axle stands must always be placed under the vehicle supporting the weight - before work is carried out.



Use stands after jacking a vehicle

Ramps and Hoists Many ramps or hoists are available. These range from large four-post wheel-free types to smaller single-post lifts. These items should be inspected regularly to ensure they are safe.



Four post lift in use

Transmission Jack If a complete gearbox has to be removed, it is likely to be heavy! A transmission jack has attachments that allow you to support the gearbox and lower it safely. The equipment is hydraulically operated just like an ordinary jack. Often, the height can be set by using a foot pedal, which leaves both hands free for positioning the unit.



Transmission jacks are very useful

Bearing Puller Removing some bearings is difficult without a proper puller. For internal bearings, the tool has small legs and feet that hook under the bearing. A threaded section is tightened to pull out the bearing. External pullers hook over the outside of the bearing and a screwed thread is tightened against the shaft. These tools may be essential for gearbox work.



Internal and external bearing pullers

Air Tools The whole point of power tools is that they do the work so you don't have to! However, air guns produce a 'hammer' action, and because of this, impact sockets should be used. Normal sockets can shatter under this load. It is important to remember that air tools need lubricating from time to time. Air ratchets are very useful for removing or fitting nuts and bolts. However, it is possible to over tighten if care is not taken. Air tools can be very powerful and will trap your hands! Take adequate precautions at all times.



These tools are very useful

Slide Hammer A slide hammer is a form of puller. It consists of a steel rod over which a heavy mass slides. The mass is 'hammered' against a stop, thus applying a pulling action. The clamp end of the tool can screw either into, or onto, the component. Alternatively, puller legs with feet are used to grip under the sides of the component.

Grease Gun A grease gun is a simple device that pumps grease under pressure. A special connector fits onto a grease nipple. Some types are air operated but the one shown here is a simple pump action type.



Look back over the previous section and write out a list of the key bullet points here:

ROUTINE MAINTENANCE

Scheduled Servicing Scheduled service requirements are often quite simple but none-the-less important. Systems should be checked for correct operation. Adjustments, repairs or replacements are then made if required. The servicing requirements for the driveshafts are limited but equally important.

Non-Routine Work When carrying out routine maintenance, some non-routine work may be found. This should be reported to the driver or owner of the vehicle before expensive repairs are carried out.



Transmission
oil leak



Worksheet Service transmission system.

The service requirements for the transmission system are straightforward. However, it is still important that the work is carried out regularly and with care. The task mostly involves a quick check of the system and topping up of the oils. Note that you should always check manufacturers' data for the correct lubricant type.

Gearbox Service To gain access to the gearbox and other components, jack up and support the vehicle or raise it on a hoist. Remove the plug in the side of the gearbox. This will require a square or a hexagonal tool. Note that two plugs are fitted, one to drain the oil at the bottom and the upper one for filling up. If the oil is not at the bottom of the upper opening, use a pump or 'squeeze' bottle to top up. Do this until the oil just runs out of the hole. Refit the plug securely but do not over tighten and strip the threads.



Filling the gearbox oil

Transmission Service □□□ If appropriate, repeat the previous procedure for the overdrive unit and final drive assemblies. Clean the areas around the plugs, gaskets and any seals by wiping with a cloth. Road test the vehicle and then check for leaks. Double check that any plugs and covers, which were removed, have been refitted securely. Lower the vehicle to the ground.

Summary This transmission service task will normally be carried out as part of a general service. If other work such as a serious leak is noticed, this should be reported to the customer.



Look back over the previous section and write out a list of the key bullet points here:

MANUAL GEARBOX - CUSTOMER CARE

Regular Checks Regular servicing is vital for a customer's safety. Carry out checks at all services and report your findings to the customer. Advise customers if anything will need attention before the next scheduled service interval.

Vehicle Condition Respect your customer's vehicle and take precautions to keep it clean. Repairing or checking some systems, is likely to involve you working under the vehicle, and then sitting in the driver's seat. Use seat covers and ensure the steering wheel is clean when you have finished.

Keep Customers Informed Some customers like to know details of what work has been done to their vehicle - and they have every right to know! This driveshaft gaiter had split and unfortunately, the CV joint had been damaged due to loss of lubrication and dirt getting in. The customer appreciated having the situation explained.

Test Drives Take the customer on a test drive if necessary. It is a useful way of helping them to describe problems to you. Alternatively, they could drive and demonstrate what is concerning them. Simple problems like wheel bearing noise can be diagnosed easily in this way.

Shifting Should a customer express concern about shifting (gear changing), carry out a few simple checks before removing the transmission. With the engine stationary, check that the clutch pedal and gear lever can move freely. Check for correct fitment of mats, rubber gaiters and sound damping material. Look for play and wear in the gear lever guide and engagement of the shift rod bolt in the universal joint. With the engine running, check for correct clutch disengagement.

Transmission Noises Should a customer express concern about transmission noises, a few simple checks should be carried out before carrying out any repairs. Check that the outer and inner rubber gaiters, and the sound damping material are fitted correctly on the gear lever. Make sure that the transmission is correctly filled with transmission fluid.

Leaks Should a customer express concern about fluid leaks, the leak must be located before attempting any repairs. Clean the transmission and add some fluorescent additive to the transmission oil. Road test the vehicle and then locate the leak using an ultraviolet lamp.

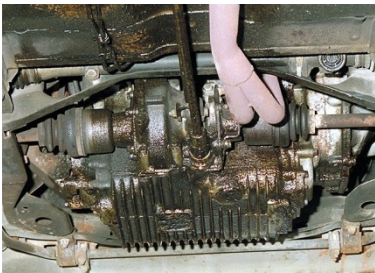

This oil leak was obvious!

Summary A customer, who is kept informed and treated with respect, will return and keep you in a job! Explain things to a customer when asked - it will be appreciated.

TRANSMISSION DRIVELINE

PROPSHAFTS

Introduction Propshafts, with universal joints, are used on rear or four wheel drive vehicles. They transmit drive from the gearbox output to the final drive in the rear axle. Drive, then continues through the final drive and differential, via two half shafts to each rear wheel.



Propshaft

Main Shaft A hollow steel tube is used for the main shaft. This is lightweight, but will still transfer considerable turning forces. It will also resist bending forces.



Section of a propshaft

Universal Joints (UJs) Universal joints, allow for the movement of the rear axle with the suspension, while the gearbox remains fixed. Two joints are used on most systems and must always be aligned correctly.



Details of a UJ

Variable Velocity □□□ Because of the angle through which the drive is turned, a variation in speed results. This is caused because two arms of the UJ rotate in one plane and two in another. The cross of the UJ therefore, has to change position twice on each revolution. However, this problem can be overcome by making sure the two UJs are aligned correctly.

Universal Joint Alignment If the two UJs on a propshaft are aligned correctly, the variation in speed caused by the first can be cancelled out by the second. However, the angles through which the shaft works must be equal. The main body of the propshaft will run with variable velocity but the output drive will be constant.

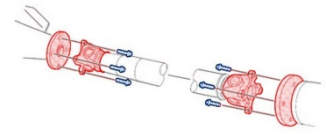

These joints are aligned correctly

UJ Bearings The simplest and most common type of UJ consists of a four point cross, which is sometimes called a spider. Four needle roller bearings are fitted, one on each arm of the cross. Two bearings are held in the driver yoke and two in the driven yoke.



Details of a universal joint

UJ Developments Several types of UJ have been used on vehicles. These developed from the simple 'Hooke' type joint, to the later cross-type, often known as a Hardy Spicer. Rubber joints are also used on some vehicles.



Hooke-type joint

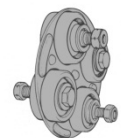

Layrub joint

Rubber Couplings The donut coupling has the advantage that it is flexible and absorbs torsional shocks. It will also tend to reduce vibrations caused by other joints. Its other main advantage is that it allows some axial (back and forth) movement.

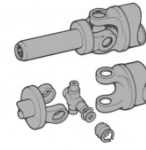

Cross-type joint

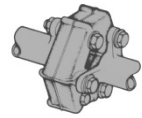

Donut joint

Suspension Movement □□□ As the suspension moves up and down, the length of the driveline changes slightly. As the rear wheels hit a bump, the axle moves upwards. This tends to shorten the driveline. The splined sliding joint allows for this movement.

Sliding Joint A sliding joint allows for axial movement. However, it will also transfer the rotational drive. Internal splines are used on the propshaft so that the external surface is smooth. This allows an oil seal to be fitted in to the gearbox output casing.



A splined joint connects to the gearbox

Centre Bearings When long propshafts are used, there is a danger of vibration. This is because the weight of the propshaft can cause it to sag slightly and therefore 'whip' (like a skipping rope) as it rotates. Most centre bearings are standard ball bearings mounted in rubber.



This bearing prevents propshaft whip

Summary Propshafts are used on rear or four-wheel drive vehicles. They transmit drive from the gearbox output to the rear axle. Most propshafts contain two universal joints (UJs). A single joint produces rotational velocity variations, but this can be cancelled out if the second joint is aligned correctly. Centre bearings are used to prevent vibration due to propshaft whip.



State the purpose of the splined joint on a propshaft.



Look back over the previous section and write out a list of the key bullet points here:

DRIVESHAFTS

Introduction □□□ Driveshafts with constant velocity joints transmit drive from the output of the final drive and differential, to each front wheel. They must also allow for suspension and steering movements.

Constant Velocity (CV) Joint A CV joint is a universal joint, however, it is constructed so that the output rotational speed is the same as the input speed. The speed rotation remains constant even as the suspension and steering move the joint.



Outer CV joint

Inner and Outer Joints The inner and outer joints have to perform different tasks. The inner joint has to plunge in and out, to take up the change in length as the suspension moves. The outer joint has to allow suspension and steering movement up to about 45 degrees. A solid steel shaft transmits the drive.



Inner CV joint

CV Joint Operation When a normal UJ operates, the operating angle of the cross changes. This is what causes the speed variations. A CV joint spider (or cross) operates in one plane because the balls or rollers are free to move in slots. The cross bisects the driving and driven planes.

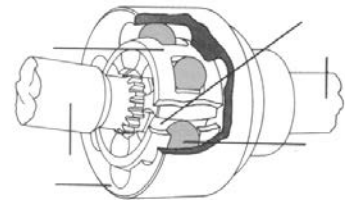

Details of a CV joint

Gaiter or Boot □□□ The rubber boot or gaiter is to keep out the dirt and water, and keep in the lubricant. Usually a graphite or molybdenum grease is used but check the manufacturer's specifications to be sure.

CV Joint Variations □□□ There are a number of different types of constant velocity joint. The most common is the Rzeppa (pronounced reh-ZEP-ah). The inner joint must allow for axial movement due to changes in length as the suspension moves.

Rzeppa Joint The Rzeppa joint is one of the most common. It has six steel balls held in a cage between an inner and outer race inside the joint housing. Each ball rides in its own track on the inner and outer races. The tracks are manufactured into an arch shape so that the balls stay in the mid-point at all times, ensuring that the angle of the drive is bisected. This joint is used on the outer end of a driveshaft. It will handle steering angles of up to 45 degrees.

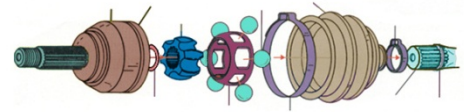

CV joint - Rzeppa type

Cross Groove Joint The cross groove CV joint is like a compact version of the Rzeppa joint. However, unlike the Rzeppa joint, the cross groove type can plunge up to about 52mm (2 inches). It is more compact but the operating angle is limited to about 22 degrees. It can be used where space is at a premium.

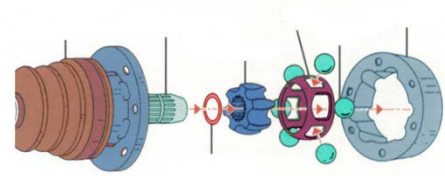

CV joint - Cross groove type

Double Offset Joint The double offset joint is a further variation of the Rzeppa joint. The main difference is that the outer race has long straight tracks. This allows a plunge (axial movement) of up to 55mm (2.1 inches) and a steering angle of up to 24 degrees.

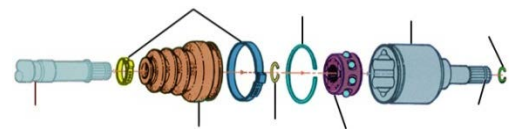

CV joint - Double offset type

Tripod Joint The tripod joint is different from other CV joints. A component called a spider splits the drive angle. The arms of the spider give it the tripod name. Each arm of the spider has needle roller bearings and a roller ball. The roller balls work in grooves in the housing. This joint is suitable for inner or outer positions.

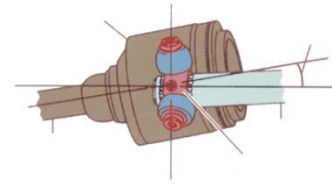

CV joint - Tripod type

Summary Driveshafts with CV joints are used on front wheel drive vehicles. They transmit drive from the differential, to each front wheel. They must also allow for suspension and steering movements. Inner joints must 'plunge' to allow for changes in length of the shaft. Several types of CV joint are used. All types work on the principle of bisecting the drive angle to produce a constant velocity output.



Look back over the previous section and write out a list of the key bullet points here:

Types of Bearing

There are two main types of bearing used in rear wheel hubs.

These are ball bearings and roller, or tapered roller bearings.



Ball bearing



Roller bearing

Rear Wheel Bearings Axle shafts transmit drive from the differential to the rear wheel hubs. An axle shaft has to withstand:

Torsional stress due to driving and braking forces

Shear and bending stress due to the weight of the vehicle

Tensile and compressive stress due to cornering forces.

A number of bearing layouts are used, depending on application, to handle these stresses.

Semi Floating Shown here is a typical axle mounting used on many rear wheel drive cars. A single bearing is used, which is mounted in the axle casing. With this design, the axle shaft has to withstand all the operating forces. The shaft is therefore strengthened and designed to do this. An oil seal is incorporated because oil from the final drive can work its way along the shaft. The seal prevents the brakes being contaminated.

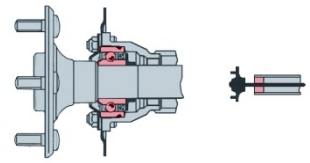

Wheel bearing -
Semi floating

Three Quarter Floating The three quarter floating bearing shown here reduces the main shear stresses on the axle shaft but the other stresses remain. The bearing is mounted on the outside of the axle tube. An oil seal is included to prevent the brake linings from being contaminated.

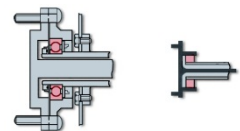

Wheel bearing -
Three Quarter
floating

Fully Floating Fully floating systems are generally used on heavy, or off-road vehicles. This is because the stresses on these applications are greater. Two widely spaced bearings are used, which take all the loads, other than torque, off the axle shaft. Bolts or studs are used to connect the shaft to the wheel hub. When these are removed, the shaft can be taken out without jacking up the vehicle.

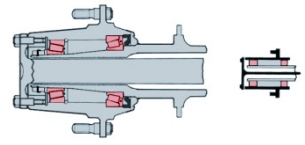

Wheel bearing -
Fully floating

Front Wheel Bearings Front hubs on rear wheel drive cars consist of two bearings. These are either ball or tapered roller types. The roller types are generally used on earlier vehicles. They have to be adjusted by tightening the hub nut and then backing it off by about half a turn. The more modern hub bearings, known as contact type ball races, do not need adjusting. This is because the hub nut tightens against a rigid spacer. This nut must always be set at a torque specified by the manufacturer.

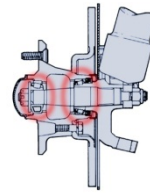

Front hub with tapered roller bearings

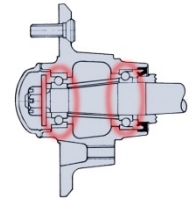

Front hub with ball bearings

Summary The most common systems for rear wheel drive cars are semi floating rear bearings at the rear, and twin ball bearings at the front. The front bearings are designed to withstand side forces as well as vertical loads.



Rear hub



Front hub



State the two main types of bearing used in rear wheel hubs



Look back over the previous section and write out a list of the key bullet points here:

FRONT WHEEL DRIVE BEARINGS

Introduction Wheel bearings must allow smooth rotation of the wheel but also be able to withstand high stresses such as when cornering. Front wheel drive arrangements must also allow the drive to be transmitted via the driveshafts.

Front Bearings The front hub works as an attachment for the suspension and steering as well as supporting the bearings. It supports the weight of the vehicle at the front, when still or moving. Ball or roller bearings are used for most vehicles with specially shaped tracks. This is so the bearings can stand side loads when cornering. The bearings support the driveshaft as well as the hub.

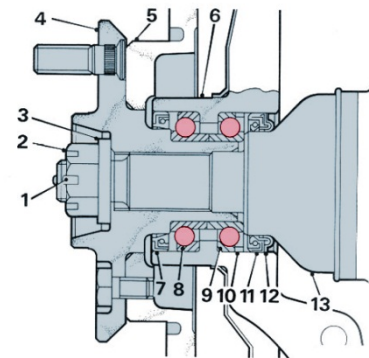

Front hub and bearings

Rear Bearings The stub axle, which is solid-mounted to the suspension arm, fits in the centre of two bearings. The axle supports the weight of the vehicle at the rear, when still or moving. Ball bearings are used for most vehicles with specially shaped tracks for the balls. This is so the bearings can stand side loads when cornering. A spacer is used to ensure the correct distance between, and pressure on, the two bearings.

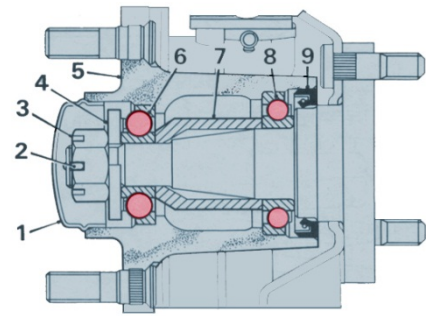

Rear hub and bearings

Summary The hub and bearing arrangement on the front, of a front wheel drive car, must bear weight, withstand driving forces and support the driveshaft. The rear hub and bearings must support the vehicle and withstand side forces.



Describe the function of front wheel hub.



Look back over the previous section and write out a list of the key bullet points here:

TOOLS AND EQUIPMENT

Introduction Components will usually be removed, inspected and repaired or replaced when a defect has been diagnosed. Other components are replaced, or stripped and cleaned, at scheduled mileage or time intervals. Refer to the Routine Maintenance Section for details on these items.

Recommended Procedures The descriptions provided in this section deal with the components for individual replacement, rather than as a part of other work. Always refer to a workshop manual before starting work. You will also need to look for the recommended procedure, special tools, materials, tightening sequences and torque settings. Some general and specific tools and pieces of equipment are described on the following screens.

General Toolkit General tools and equipment will be required for most tasks. As your career develops you will build a collection of tools and equipment. Look after your tools and they will look after you!



Snap-on tools

Torque Wrench A good torque wrench is an essential piece of equipment. Many types are available but all work on a similar principle. Most are set by adjusting a screwed cylinder, which forms part of the handle. An important point to remember is that regular calibration is essential to ensure it remains accurate.



A torque wrench is a useful tool

Air Guns The whole point of power tools is that they do the work so you don't have to! Most air guns have an aluminium housing. This material is lightweight but gives long life. Air guns produce a 'hammer' action. Because of this, impact sockets should be used. Normal sockets can shatter under this load. It is important to remember that air tools need lubricating from time to time.



Wheel gun in use

Jacks and Stands Most jacks are simple hydraulic devices. Remember to make sure the safe working load (SWL) is not exceeded. Ensure that any faults with equipment such as this are reported immediately. Axle stands must always be placed under the vehicle supporting the weight - before work is carried out.



Always use stands after jacking a vehicle

Ramps and Hoists Many ramps are available ranging from large four-post wheel-free types to smaller single-post lifts. These large items should be inspected regularly to ensure they are safe.

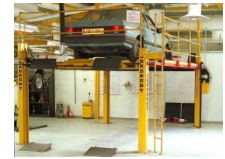

Four post lift in use

Transmission Jack If a complete gearbox has to be removed, it is likely to be heavy! A transmission jack has attachments that allow you to support the gearbox and lower it safely. The equipment is hydraulically operated just like an ordinary jack. Often, the height can be set by using a foot pedal, which leaves both hands free for positioning the unit.



This jack will support a gearbox

Bearing Puller Removing some bearings is difficult without a proper puller. For internal bearings, the tool has small legs and feet that hook under the bearing. A threaded section is tightened to pull out the bearing. External pullers hook over the outside of the bearing and a screwed thread is tightened against the shaft.



Internal and external bearing pullers

Air Ratchet These tools are very useful for removing or fitting nuts and bolts. However, it is possible to over tighten if care is not taken. Air tools can be very powerful and will trap your hands! Take adequate precautions at all times.



These tools are very useful

Slide Hammer A slide hammer is a form of puller. It consists of a steel rod over which a heavy mass slides. The mass is 'hammered' against a stop, thus applying a pulling action. The clamp end of the tool can screw either into, or onto, the component. Alternatively, puller legs with feet are used to grip under the sides of the component.



This tool is useful for removing halfshafts

Grease Gun A grease gun is a simple device that pumps grease under pressure. A special connector fits onto a grease nipple. Some types are air operated but the one shown here is a simple pump action type.



Some older UJs can be lubricated



Look back over the previous section and write out a list of the key bullet points here:

Scheduled Servicing Scheduled service requirements are often quite simple but important. Systems should be checked for correct operation. Adjustments, repairs or replacements are then made if required. The particular servicing requirements for driveshafts are limited but none-the-less essential.

Non-Routine Work When carrying out routine maintenance, some non-routine work may be found. This should be reported to the driver or owner of the vehicle before expensive repairs are carried out.



Damaged CV gaiter



Worksheet Service rear wheel drive propshaft.

This task would normally be carried out as part of a general vehicle service and inspection. However, it may be necessary to check the propshaft at other times. Apply the handbrake and raise the vehicle on a hoist. Make sure the area is well lit so that you can see details. Take care if the exhaust is still hot.

Propshaft The first task is to check the propshaft for security and signs of damage. Make sure that any balance weights are secure. Look at the gearbox output seal where the propshaft sliding joint fits, and make sure it is not leaking. If the general area under the vehicle is oily, it may be necessary to steam clean it first.



Checking the universal joints

Universal Joints Check all the universal joints (UJs) for signs of leakage. If grease is leaking, this may be a sign that the UJ is overheating and in need of replacement. Some types have a grease point fitted. If this is the case, use a grease gun to pump new grease into each. Clean off any excessive grease. Finally, check all mounting bolts for security.



Grease gun



Worksheet Service front wheel drive



Driveshaft

driveshafts.

This task would normally be carried out as part of a general vehicle service and inspection. However, it may be necessary to check the driveshafts at other times. Apply the handbrake and raise the vehicle on a hoist. Make sure the area is well lit so that you can see details. It is particularly important to check the area around the rubber gaiters.

Driveshafts The first task is to check driveshafts for security and signs of damage. Make sure that any balance weights and dampers are secure. The dampers are simple rubber components, if fitted. Check for oil leaks from the final drive output seals. Clean the area first and then check for clean oil. It may be necessary to take the vehicle on a road test, to show up any problems.



Driveshaft and CV gaiters in position

Constant Velocity Joints Take particular care to check constant velocity joint gaiters/boots for signs of leakage. Look for signs of black coloured grease. It is possible for the strap or 'cable tie' that holds the gaiter, to come loose. Replace gaiters if cuts or any other damage is evident. If grease has been lost, repack the joint with the correct type. Clean off any excess from the driveshaft and surrounding area. Finally, check the main driveshaft nut and any other flange bolts for security.



Checking the gaiters

Summary Safety of all road users and pedestrians is essential. Reliable operation of the vehicle is also important. The condition of all systems is therefore vital. Carry out a check at all service intervals.



Safety is important



Look back over the previous section and write out a list of the key bullet points here:

DRIVELINE - CUSTOMER CARE

Regular Checks Regular servicing is vital for a customer's safety. Carry out checks at all services and report your findings

to the customer. Advise customers if anything will need attention before the next scheduled service interval.

Vehicle Condition Respect your customer's vehicle and take precautions to keep it clean. Repairing or checking some systems, is likely to involve you working under the vehicle, and then sitting in the driver's seat. Use seat covers and ensure the steering wheel is clean when you have finished.

Describing Noise Driveline problems often result in unusual noises from the vehicle as it is used. Noise is very difficult to describe! However, the following screen describes some useful terms. These may be useful when discussing problems with your colleagues or customers.

Noise □□□ 'Howling' or 'whining', tends to be a noise associated with gears. It can occur at various speeds and driving conditions, or it can be continuous. 'Chuckle' is a rattling noise that sounds like a stick held against the spokes of a spinning bicycle wheel. It usually occurs while decelerating. 'Knock' is very similar to 'chuckle' though it may be louder and occurs on acceleration or deceleration.

Causes of Noise Clicking, popping or grinding noises may noticeable at low speeds and be caused by:

- Inner or outer CV joints worn (often due to lack of lubrication so check for split gaiters)
- Loose driveshaft
- Another component contacting a drive shaft

- Damaged or incorrectly installed wheel bearing, brake or suspension components.

Vibration The following faults may cause vibration at normal road speeds:

- Out-of-balance wheels
- Out-of-round or damaged tyres.
- The following may cause shudder or vibration during acceleration:
 - Damaged powertrain/drivetrain mounts
 - Excessively worn or damaged, outboard or inboard, CV joints.

Summary A customer, who is kept informed and treated with respect, will return and keep you in a job! Explain things to a customer when asked - it will be appreciated.

FINAL DRIVE AND DIFFERENTIAL

FINAL DRIVE

Introduction Because of the speed at which an engine runs, and in order to produce enough torque at the road wheels, a fixed gear reduction is required. This is known as the final drive. It consists of just two gears. The final drive is fitted after the output of the gearbox on front wheel drive vehicles. It is fitted in the rear axle after the propshaft on rear wheel drive vehicles.



Front wheel
final drive



Rear wheel
final drive

Gear Ratio □□□ The ratio is normally between about 2:1 and about 4:1. In other words, at 4:1, when the gearbox output is turning at 4000 rev/min, the wheels will turn at 1000 rev/min.

Rear Wheel

Drive The final drive gears turn the drive through ninety degrees on rear wheel drive vehicles.

Four-wheel drive vehicles will also have this arrangement as part of the rear axle.

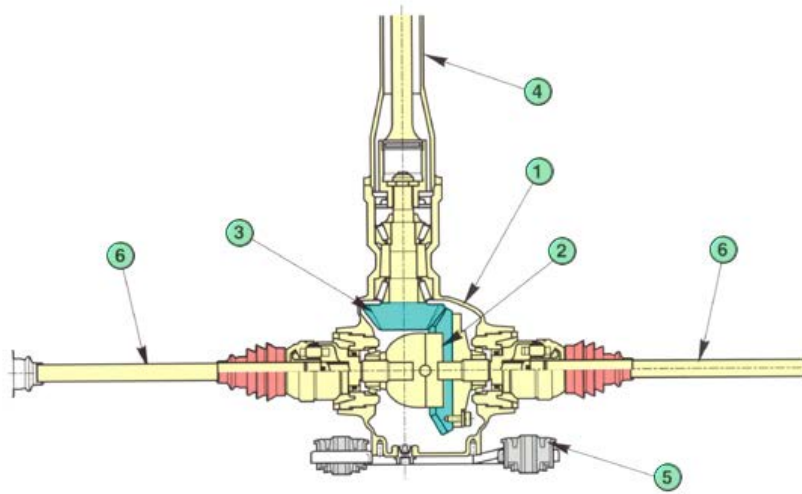

Rear axle final drive gears

Front Wheel Drive Most cars now have a transverse engine, which drives the front wheels. The power of the engine therefore does not have to be carried through a right angle to the drive wheels. The final drive contains ordinary reducing gears rather than bevel gears.

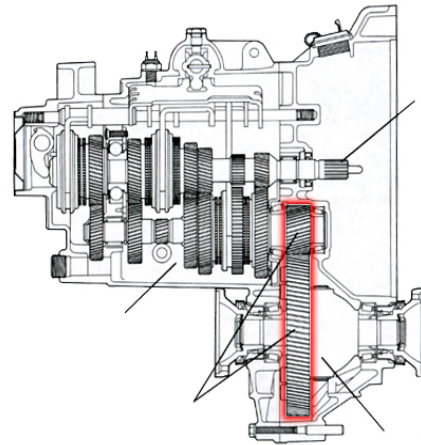

Transaxle final drive gears

Bevel Gears The crown wheel and pinion are types of bevel gears because they mesh at right angles to each other. They carry power through a right angle to the drive wheels. The crown wheel is driven by the pinion, which receives power from the propeller shaft.

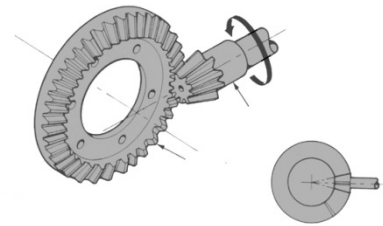

Bevel gears change ratio and drive angle

Reduced Speed and Increased Torque Final drive gears reduce the speed from the propeller shaft and increase the torque. The reduction in the final drive multiplies any reduction that has already taken place in the transmission.

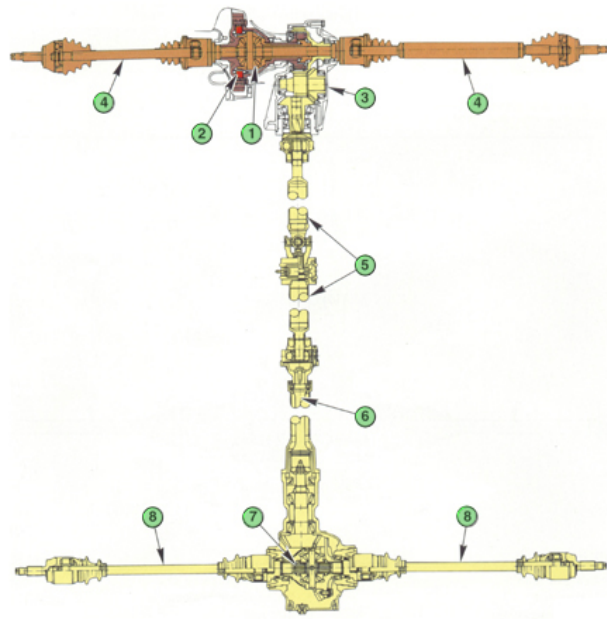

4WD final drive layout

Hypoid Gear The crown wheel gear, of a rear wheel drive system, is usually a hypoid type, which is named after the way the teeth are cut. As well as quiet operation, this allows the pinion to be set lower than the crown wheel centre, thus saving space in the vehicle because a smaller transmission tunnel can be used.

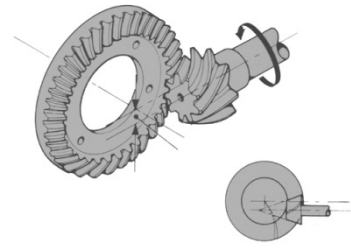

The design allows a lower propshaft to be used

Hypoid Gear Oil Because the teeth of hypoid gears cause 'extreme pressure' on the lubrication oil, a special type is used. This oil may be described as 'Hypoid Gear Oil' or 'EP', which stands for extreme pressure. As usual, refer to manufacturers' recommendations when topping up or changing oil.



Lubrication is important

Rear Axle □□□ The complete rear axle assembly consists of other components as well as the final drive gears. The other main components are the differential, halfshafts and bearings. Components that make up a solid axle are shown here. Some rear wheel drive and four-wheel drive vehicles have a split axle. On these types, the final drive is mounted to the chassis and driveshafts are used to connect to the wheels.

Front Axle  The front wheel drive axle, where a transaxle system is used, always consists of the final drive and two driveshafts. The gearbox, final drive and one driveshaft are shown here. The final drive gears provide the same reduction, as those used on rear wheel drives, but do not need to turn the drive through ninety degrees.

Four Wheel Drive The general layout of a four-wheel drive system is shown here. A representation of how torque is distributed is also shown. The variation in torque is achieved by differential action. This is examined in some detail later in this programme.

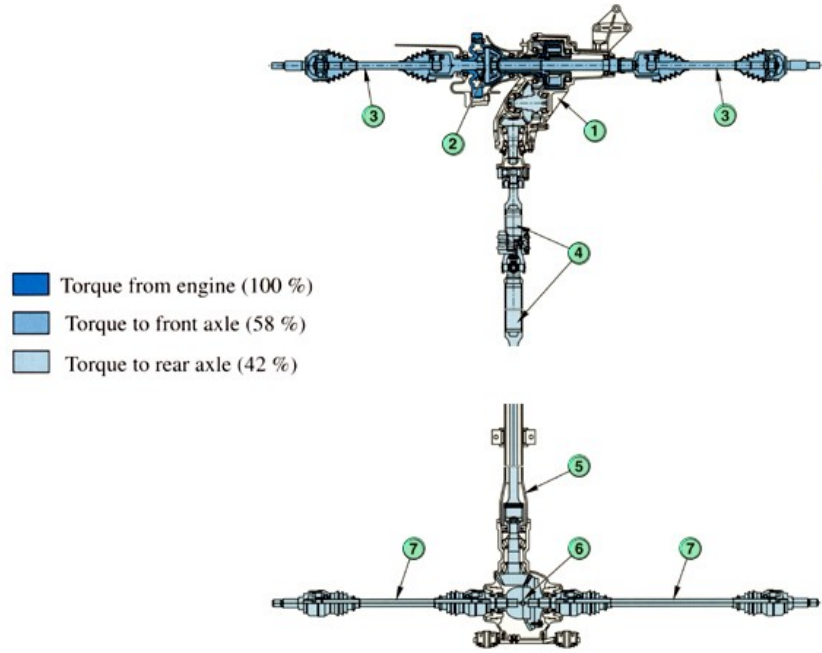

Torque distribution in a 4WD system

Summary To produce enough torque at the road wheels, a fixed gear reduction is required. This is known as the final drive. It consists of just two gears. On rear wheel drive systems, the gears are bevelled to turn the drive through ninety degrees. On front wheel drive systems, this is not necessary. The drive ratio is similar for front or rear wheel drive cars.



Describe the purpose of final drive gears.



Look back over the previous section and write out a list of the key bullet points here:

DIFFERENTIAL OPERATION

Introduction The differential is a set of gears that divides the torque evenly between the two drive wheels. The differential allows one wheel to rotate faster than the other. As a car goes around a corner, the outside driven wheel travels further than the inside one. The outside wheel must therefore rotate faster than the inside one to cover the greater distance in the same time. Tyre scrub and poor handling would be the result if a fixed axle were used.

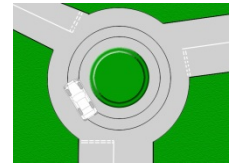

The outer wheels travel a greater distance

Main Components □□□ The differential consists of sets of bevel gears, and pinions within a cage, attached to the large final drive gear. The bevel gears can be described as sun and planet gears. The sun gears provide the drive to the wheels via halfshafts or driveshafts. The planet gears either rotate with the sun gears or rotate around them, depending on whether the car is cornering or not.

Final Drive Gears □□□ The small pinion brings the drive from the gearbox to the larger final drive gear. A fixed gear reduction is produced by the crown wheel and pinion. On rear wheel drive cars, bevel gears are used to turn the drive through ninety degrees.

Differential Casing and Bearings □□□ The bearings support the differential casing, which is in turn bolted to the final drive gear. The casing transmits the drive from the final drive gear, to the planet gear pinion shaft.

Sun and Planet Pinions □□□ The planet gears are pushed round by their shaft. The sun gear pinions, which are splined to the drive shafts, take their drive from the planet gears. The sun gears always rotate at the same speed as the road wheels.

Planet Shaft □□□ The planet shaft is secured in the differential casing so that it pushes the planet gears. If the sun gears, which are attached to the road wheels via the driveshafts, are moving at the same speed, the planet gears do not spin on their shaft. However, when the vehicle is cornering, the sun gears need to move at different speeds. In this case, the planet gears spin on the shaft to make up for the different wheel speeds.

Travelling In a Straight Line □□□ When the vehicle is travelling in a straight line, the bevel pinions (planet gears) turn with the sun gears, but do not rotate on their shaft. This occurs because the two sun gears attached to the driveshafts are revolving at the same speed.

Cornering □□ When the vehicle is cornering, the bevel pinions (planet gears) roll round the sun gears, and rotate on their shaft. This rotation is what allows the outer wheel to turn faster than the inner.

Torque Equaliser □□ A standard differential can be described as a torque equaliser. This is because the same torque is provided to each wheel, even if they are revolving at different speeds. At greater speeds, more power is applied to the wheel, so the torque remains the same.



Differential

Extreme Example One further way to understand the differential action is to consider the extreme situation. This is when the corner is so sharp, the inner wheel does not move at all! Now of course this is impossible, but it can be simulated by jacking up one wheel of the car. All the drive is transferred to the free wheel. The planets roll around the stationary sun wheel but drive the free wheel because they are rotating on their shaft.

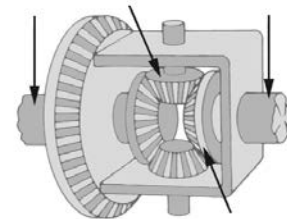

All the drive is transferred to the free wheel

Stuck In The Mud! □□□ The example, given on the last screen, highlights the one problem with a differential. If one of the driven wheels is stuck in the mud, all the drive is transferred to that wheel and it normally spins. Of course, in this case, drive to the wheel on the hard ground would be more useful. The solution to this problem is the limited slip differential.

Summary As a car goes around a bend, the outside driven wheel travels further than the inside one. The outside wheel must therefore rotate faster to cover the greater distance in the same time. The differential allows this difference in speed.



Describe what happens to the planet gears when a vehicle is driven with one wheel spinning in mud.



Look back over the previous section and write out a list of the key bullet points here:

TOOLS AND EQUIPMENT

Introduction Components will usually be removed, inspected and repaired or replaced when a defect has been diagnosed. Other components are replaced, or stripped and cleaned, at scheduled mileage or time intervals. Refer to the Routine Maintenance Section for details on these items.

Recommended Procedures The descriptions provided in this section deal with the components for individual replacement, rather than as a part of other work. Always refer to a workshop manual before starting work. You will also need to look for the recommended procedure, special tools, materials, tightening sequences and torque settings. Some general and specific tools and pieces of equipment are described on the following screens.

General Toolkit General tools and equipment will be required for most tasks. As your career develops you will build a collection of tools and equipment. Look after your tools and they will look after you!

Soft Hammers These tools allow a hard blow without causing damage. They are ideal for working on driveshafts, gearboxes and final drive components. Some types are made of special hard plastics whereas some are described as copper/hide mallets. This type has a copper insert on one side and a hide or leather insert on the other. It is still possible to cause damage however, so you must still take care!



Some hammers contain metal shot to give a 'dead blow'

Special Turning Tools

This tool is used for turning differential bearing nuts and other similar components. It is, for example, ideal for holding the input flange to a rear wheel drive axle, as the main nut is undone. Many workshops have 'home made' versions. Most types are adjustable so they will fit a variety of applications.

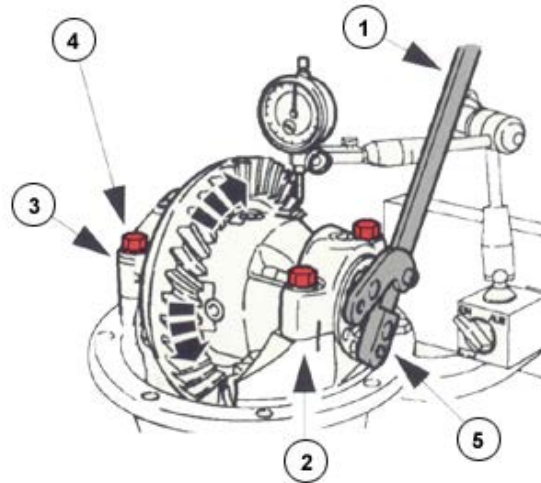

Many special tools of this type are available

Jacks and Stands Most jacks are simple hydraulic devices. Remember to make sure the safe working load (SWL) is not exceeded. Ensure that any faults with equipment such as this are reported immediately. Axle stands must always be placed under the vehicle supporting the weight - before work is carried out.

Ramps and Hoists Many ramps are available ranging from large four-post wheel-free types to smaller single-post lifts. These large items should be inspected regularly to ensure they are safe.

Transmission Jack If a complete gearbox has to be removed, it is likely to be heavy! A transmission jack has attachments that allow you to support the gearbox and lower it safely. The equipment is hydraulically operated just like an ordinary jack. Often, the height can be set by using a foot pedal, which leaves both hands free for positioning the unit.



This jack will support a gearbox

Bearing Puller Removing some bearings is difficult without a proper puller. For internal bearings, the tool has small legs and feet that hook under the bearing. A threaded section is tightened to pull out the bearing. External pullers hook over the outside of the bearing and a screwed thread is tightened against the shaft.



Internal and external bearing pullers

Air Tools The whole point of power tools is that they do the work so you don't have to! Air guns produce a 'hammer' action. Because of this, impact sockets should be used. Normal sockets can shatter under this load. It is important to remember that air tools need lubricating from time to time. Air ratchets are very useful for removing or fitting nuts and bolts. However, it is possible to over tighten if care is not taken. Air tools can be very powerful and will trap your hands! Take adequate precautions at all times.



These tools are very useful

Slide Hammer A slide hammer is a form of puller. It consists of a steel rod over which a heavy mass slides. The mass is 'hammered' against a stop, thus applying a pulling action. The clamp end of the tool can screw either into, or onto, the component. Alternatively, puller legs with feet are used to grip under the sides of the component.



These tools are useful for removing halfshafts

Grease Gun A grease gun is a simple device that pumps grease under pressure. A special connector fits onto a grease nipple. Some types are air operated but the one shown here is a simple pump action type.



Look back over the previous section and write out a list of the key bullet points here:

ROUTINE MAINTENANCE

Scheduled Servicing Scheduled service requirements are often quite simple but none-the-less important. Systems should be checked for correct operation. Adjustments, repairs or replacements are then made if required. The servicing requirements for the driveshafts are limited but none-the-less important.



Worksheet Service final drive and differential

Jack up and support the vehicle or raise it on a hoist. Inspect the area around the final drive and differential unit for oil leaks. If necessary clean off old oil, road test and check again. Pay particular attention to the main gasket seals and the driveshaft output oil seals and/or the pinion input seal. Remove the filler/level plug and check the oil level. The oil should be level with or just below the threads of the plug. Check with a finger or probe if necessary.

Front Wheel Drive If topping up is necessary, refer to the manufacturer's specifications for the correct oil. On many front wheel drive cars, the oil for the final drive and differential is the same as for the main gearbox because the units are combined. Some vehicles should have the oil changed at certain intervals. If this is the case, drain out the old oil into a tray. It is better to do this after a road test during which time the oil will become warmer and therefore drain out more easily. Some rear axle final drive and differential units do not have a drain plug. In this case, the cover must be removed to drain oil.

Rear Wheel Drive On rear wheel drive vehicles with fixed axles and halfshafts, it may be necessary to check for oil leaks into the brake drums on the rear. This would normally be carried out during servicing of the brakes. Refit any plugs and covers that were removed. Lower the vehicle to the ground.



Worksheet Service 4WD/AWD final drives and

differentials

This operation is similar to the previous task. However, 4WD/AWD vehicles have three differentials and a transfer box. Raise and support the vehicle or use a hoist. Check and top up oil levels; front gearbox/ final drive and/or transfer box and rear differential. Check all seals and gaskets for leaks. Check security and condition of all mountings and drive joints.

Electronic Systems Some four-wheel drive systems are now electronically controlled. If so, carry out a fault code check of the system. Dedicated test equipment may be required. However, a 'fault memory' warning light will be lit if a problem is stored in memory.



Look back over the previous section and write out a list of the key bullet points here:

CUSTOMER CARE

Regular Checks Regular servicing is vital for a customer's safety. Carry out checks at all services and report your findings to the customer. Advise customers if anything will need attention before the next scheduled service interval.

Vehicle Condition Respect your customer's vehicle and take precautions to keep it clean. Repairing or checking some systems, is likely to involve you working under the vehicle, and then sitting in the driver's seat. Use seat covers and ensure the steering wheel is clean when you have finished.

Keep Customers Informed Some customers like to know details of what work has been done to their vehicle - and they have every right to know! This driveshaft gaiter had split and unfortunately, the CV joint had been damaged due to loss of lubrication and dirt getting in. The customer appreciated having the situation explained.

Test Drives Take the customer on a test drive if necessary. It is a useful way of helping them to describe problems to you. Alternatively, they could drive and demonstrate what is concerning them. Simple problems like wheel bearing noise can be diagnosed easily in this way.

Shifting Should a customer express concern about shifting (gear changing), carry out a few simple checks before removing the transmission. With the engine stationary, check that the clutch pedal and gear lever can move freely. Check for correct fitment of mats, rubber gaiters and sound damping material. Look for play and wear in the gear lever guide and engagement of the shift rod bolt in the universal joint. With the engine running, check for correct clutch disengagement.

Transmission Noises Should a customer express concern about transmission noises, a few simple checks should be carried out before carrying out any repairs. Check that the outer and inner rubber gaiters, and the sound damping material are fitted correctly on the gear lever. Make sure that the transmission is correctly filled with transmission fluid.

Leaks Should a customer express concern about fluid leaks, the leak must be located before attempting any repairs. Clean the transmission and add some fluorescent additive to the transmission oil. Road test the vehicle and then locate the leak using an ultraviolet lamp.

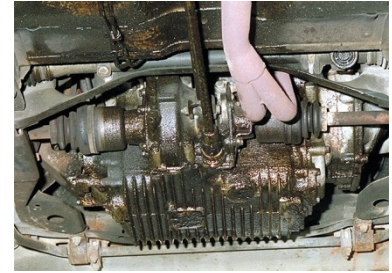

This oil leak was obvious!

Summary A customer, who is kept informed and treated with respect, will return and keep you in a job! Explain things to a customer when asked - it will be appreciated.



Look back over the previous section and write out a list of the key bullet points here: